

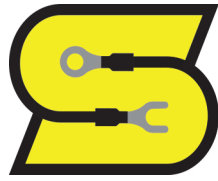

STATE WIRE
AND TERMINAL, INC.
THE COMPANY WITH CONNECTIONS™



STATE WIRE AND TERMINAL, INC.

THE COMPANY WITH CONNECTIONS™

Since 1973 State Wire & Terminal Inc. has been supplying companies like yours with a wide variety of electrical parts, industrial supplies and fasteners.

Your needs are important to us. That's why we offer **quality products**, as well as **excellent, friendly service** and **competitive prices**.

You come first at **State Wire**. Your time is important. That's why we make it as **easy** as possible for you to do business with us. Your buying efficiency **goes up** and **costs go** down when you choose **State Wire & Terminal Inc.** These features offer several benefits to you:

- When you have a question, the answer is at your fingertips in our full-line catalog!
- Find product information on our website: www.statewire.com
- If you need to talk to us, the call is **toll-free!**
- **Knowledgeable, friendly people** staff our customer satisfaction department.
- **We like helping you!**
- For the times when you're too busy to talk or need to place an order after business hours, there's a dedicated **24-hour Fax line!**
- Busy on the computer? E-mail us at sales@statewire.com
- **Orders are shipped within one business day or sooner!**
- By stocking over **12,000 parts** we can **reduce** the number of suppliers you need.
- We also accept **VISA, MASTERCARD, DISCOVER & AMERICAN EXPRESS.**

We would like the opportunity to do business with **you!** Give us a **chance. Call 1-800-922-6527** or **fax** over a **quote request** to **1-248-634-2022.**

OUR MISSION . . .

STRIVING
TO
ACHIEVE
TOTAL
EXCELLENCE

WITH
INNOVATION
RELIABILITY AND
ENTHUSIASM

- **BY TAKING THE EXTRA STEPS OUR CUSTOMERS DESERVE!**
- **BY PROVIDING THE SUPERIOR QUALITY OUR CUSTOMERS NEED!**
- **BY OFFERING THE COMPETITIVE PRICES OUR CUSTOMERS WANT!**

TABLE OF CONTENTS

SECTION A: Terminals / Connectors / Scotchloks™ / Tie-Raps

A2-3	Butt Connectors	A13	GM Metri-Pack and Pack-Con Connectors
A4-5	Ring Terminals	A14	Deutsch DT Connectors
A6-7	Quick Disconnects	A15	Scotchlok Connectors
A7	Bullets and Receptacles	A16	Twist-on Wire Connectors
A8	Spade Terminals	A16	Cable Tie Installation Tool
A9	Solder and Solder Terminals	A17	Nylon Tie-Raps
A10-11	Specialty Terminals	A18	Battery Terminals
A12	GM Weather Pack Connectors and Tools	A19	Battery Accessories

SECTION B: Miniature Bulbs / Sealed Beams / Fuse Products / Tape

B2-5	Miniature Bulbs and Halogen Capsules	B11	Glass Fuse Accessories
B6	Sealed Beams	B12	Circuit Breakers
B7	Halogen Sealed Beams	B13	Flashers
B8	Blade Fuses	B14	Relays
B9	Blade Fuse Holders	B15	Automotive Pigtails
B10	Glass Fuses and Holders	B16-17	Tapes

SECTION C: Wire / Cable / Tubing / Loom / Power Cord / Hoses / Clamps

C2	Primary Wire (General Purpose Thermoplastic)	C7	Split Loom, Expandable Flex Tubing, Power Cord
C3	Trailer Cable, Coiled Cable Assembly and Multi-Conductor Jacketed Boat Cable	C8	Heat Shrink Tubing, Fuel Line and Vapor Emission Hose, Windshield Washer and Vacuum Hose
C4	Jacketed Wire and Welding Cable	C9	Hose Clamps, Insulated Metal Clamps and Sleeved Clamps
C5	Battery Cables, Straps, Assemblies and Battery Terminal Covers	C10	Nylon Cable Clamps, Parallel Wire Clamps, Glue-On Clamps, Rubber Tie Downs, Spooled Mechanics Wire and Metal Frame Clips
C6	Ripcord (Parallel) Wire, Coaxial Cables, Commercial Coax Connectors and Speaker Wire		

SECTION D: Nuts & Bolts / Screws / Fasteners

D2-3	Cap Screws Grade 5 and 8	D11	Machine Screws
D4	Washers	D12	Sheet Metal Screws
D5	Nuts	D13	Tek Screws
D6	Nut and Bolt Assortments	D14-15	Stainless Steel Fasteners and Screws
D7	Metric Cap Screws, Nuts and Washers	D16-17	Blind Rivets
D8-9	Plated Hitch Pin Clips and Bent Arm Pins	D17	Thread Sert Assortment and Tool
D10	Locking, Lynch, Roll and Cotter Pins	D18	Grease Fittings, Rubber and Plastic Grommets

SECTION E: Switches / Replacement Keys / Truck & Trailer Products / Back-Up Alarms

E2-3	Toggle Switches and Accessories	E12	Trailer Adapters, 7-Way RV OEM Style Kits and Socket, Accessories
E5	Rocker and Push-Pull Switches	E13	7-Way Blade Connectors, Heavy Duty Trucking Plugs, Sockets and Accessories
E6	Momentary Switches, Master Disconnect and Precision Ball Switches, Accessories	E14	6-Way & 4-Way Metal Connectors and Plugs, Sockets and Accessories
E7-8	Marine Starter and Ignition Starter Switches	E15	Tarping 2-Pole Power Take Off Connectors, Single Pole Metal Connectors, Plugs and Sockets, Electrical Terms
E9	Replacement Keys, Solenoid Switches	E16	Back-Up Alarms
E10	Junction Boxes, Terminal Blocks, Valves		
E11	Electronic Brake Controls, 5704 Series Pendants, Trailer Harnesses, Molded Trailer Connectors, Electronic Taillight Converter and Coiled Cable Assemblies without ends.		

TABLE OF CONTENTS

SECTION F: LED, Incandescent, Trailer and Emergency Lighting / Lighting Accessories

F2-3	LED Stop, Turn and Tail Lights	F10	Incandescent License Plate Lights and Accessories
F3-4	LED Side Marker and Clearance Lights	F11	Plugs and Pigtails
F4	LED Back-up and Utility Lights	F11-12	Grommets
F5-6	Incandescent Stop, Turn and Tail Lights	F12-13	Brackets and Mirrors
F7-8	Incandescent Side Marker and Clearance Lights	F13-14	Trailer Lighting and Accessories
F9	Incandescent Back-up, Utility and Tractor Implement Lights	F15-16	Emergency Lighting

SECTION G: Kits / Assortments / Storage Systems

G2	GM Connector Assortments	G13	Plastic Grommet Kit, Rubber Grommet Kit and Solder Slug Kit
G3	Deutsch Connector and Insulated Connector Kits	G14	Roll Pin Assortment, Hose Clamp Assortment and Magnetic Chuck Drive Kit
G4	Shrink Tube and Shrink Tube Terminal Kits	G15	Grease Fitting Kit, Vacuum Hose Connector Assortment, Aluminum Blind Rivet Assortment and Storage Systems
G5	Fuse Kit and Copper Battery Lug Kit	G16	Storage Systems
G6-7	Brass Fitting Kit and Nylon Tie Assortments		
G8-9	Nut and Bolt Assortments		
G10-11	Screw Assortments		
G12	Cotter Pin Kit, Hit Pin Kit, Insulated Metal Clamp Kit and Wire Caddy Assortment		

SECTION H: Tools / Abrasives / Accessories

H2	Crimpers and Wire Strippers	H8-9	Hole Saw Blades and Kits, Arbors, Pilot Drills, Hacksaw Frame and Blades, Vari Bits
H3	Circuit Testers, MBX Tools, Utility Knives and Blades, Masks and Gloves	H10-11	Jobber Length, Sheet Metal, Mechanics Length, Reduced Shank Drill Bits and Drill Bit Size Table
H4-5	Mini Flap Discs, Surface Conditioning Discs, Bristle Discs, Roloc Discs and Disc Holders, Fiber Discs, Scotch-Brite Pads, Fabricut Rolls, Cloth Utility Rolls, Knotted and Crimped Wire End Brushes	H12	Insert and Power Bits
H6-7	Flap Discs, Center Wheel, Flap Wheels, Wire Wheels, Scratch Brushes, Cut-Off Wheels, Grinding Wheels, Chop and Portable Saw Blades	H13	Alkaline Batteries, Rough Service Bulbs and Butane Torches
		H14	Booster Cable Handles, Battery Charging Clips, Protective Boots, Ignition Wire and Ends, Drop Lights and Accessories

SECTION J: Chemicals

J2-4	Dynatex Products	J8	McKanica Products and Grote Chemicals
J5-6	3M Products	J9	B'Laster Products, Noco and Deka
J7	Seymour Products		

SECTION K: Brass Fittings / Grease Fittings / Air Couplers and Plugs

K2	Air Brake Nylon Tube Fittings, Push to Connect Air Brake Fittings	K5	Brass Fittings Chart
K3	Brass Pipe Fittings and Inverted Flares	K6	Hydraulic Grease Fitting Couplers, Quick Disconnect Couplers and Plugs
K4	Standard Compression Fittings, 45° SAE Flare, Air Line Hose Barbs, Ground Key Shut-Off Cocks, Push on Fittings	K7	Air Couplers and Plugs Chart

INDEX

1-way Trailer Connectors	E15
2-way Trailer Connectors	E11 E14
3-way Terminals	A10
3-way Trailer Connectors	E11
4-way Terminals	A10
4-way Trailer Connectors	E11 E14 F14
6-way Trailer Connectors	E14
7-way Trailer Connectors	E12-E13

A

Abrasives	H4-7
Adhesives	J2-6
Air Brake Fittings	G6-G7 K2
Air Hose Couplers	K6-K7
Air Line Fittings	K4
AMP Terminals	A11
Anderson Connectors	A19
ANN Fuses	B8
Anti-Seize	J4
Assortments	G2-G16
ATC Fuses	B8 G5
ATM Fuses	B8 G5
Automotive Pigtails	B15

B

Back-Up Alarms	E16
Back-Up Lights	F4 F9
Bailing Wire	C10
Batteries	H13
Battery Adapters	A18
Battery Cable	C5
Battery Cleaners	J9
Battery Corrosion Prevention	J9
Battery Jumper Terminals	E14
Battery Lugs	G5
Battery Straps	C5
Battery Terminal Adapters	A18
Battery Terminals	A18-A19 G5
Bench Grinder Wheels	H7
Bent Arm Pins	D9
Blind Rivets	D16-17 G15
Boat Cable	C3
Bolt Locker	J2
Bolts	D2-D3 D7 D14 G8-G9
Booster Cable Handles	H14
Box Sealing Tape	B17
Brake Cleaners	J3 J6
Brake Controls	E11
Brass Fittings	G6 K2-K4
Break Away Switches	E11
Bristle Discs	H4
Brush-on Electrical Tape	J4
Bulbs	B2-B5 H13
Bullet Connectors	A7 G3
Bungee Cords	C10
Butane and Torches	H13

Butt Connectors	A2-A3 A9 G3-G4 G12
-----------------------	--------------------

C

Cable	C3-7
Cable Clamps	C10
Cable Cutters	H2
Cable Ties	A16-A17 G7
Cap Screws	D2-D3 D7 D14 G8-G9
Charging Clips	H14
Charging Posts	A18
Choke & Carb Cleaner	J3
Chop Saw Blades	H7
Circuit Breaker Boxes	E10
Circuit Breakers	B12
Circuit Converters	B9
Circuit Testers	H3
Clamps	C9-C10
Clearance Lights	F3-F4 F6-F8
Clips	C10
Closed End Connectors	A10
Coaxial Cable & Connectors	C6
Coiled Cable	C3 E11
Compression Fittings	G6 K4
Connectors	A1-A15
Conspicuity Tape	B17
Convuluted Tubing	C7
Copper Lugs	A19 G5
Corner Strobe lights	F16
Cotter Pins	D10 D14 G12
Crimping Tools	A12 A14 G3 G12 H2
Cut-Off Wheels	H7

D

Decal Removers	H3
Degreasers	J9
Deutsch Connectors	A14 G3
Dielectric Grease	J4 J8
Disconnect Adapters	A7
Disconnect Terminals	A6-A7
Door Jamb Switches	E7
Drill Bits	H9-H11
Drive Bits	G14 H12
Drop Lights	H14
Dry Graphite Lubricant	J7
Dry Wall Screws	D13
Dual Lock	B17
Duct Tape	B16

E

Electrical Cleaners	J3
Electrical Connectors	A1-A15
Electrical Tape	B16
Emergency Lights	F15-F16
Engine Degreasers	J3 J9
Extension Cord Ends	H14

INDEX

Extractor Tools A12 A14 G3 H2

F

Fender Washers D4 D14
Flag Terminals A11
Flanged Spade Terminals A8
Flap Discs and Wheels H6
Flashers B13
Flat Washers D4 D7 D14 G8-G9
Flex Tubing C7
Flooring Screws D13
Fork Connectors A8 G3-G4
Frame Clamps C10
Fuel Line Hose C8
Fuel Selector Valves E10
Fuel System Cleaners J6
Fuse Blocks B11
Fuse Holders B9-B10
Fuse Links B11
Fuse Panels & Blocks B11
Fuse Taps B8 G5
Fuses B8 B10 G5

G

Gasket Makers J2
Gasket Removers J3
Glass Cleaners J6 J9
Glass Fuses B10
Gloves H3
Glue-on Clamps C10
Grease Fittings D18 G15
Grinding Wheels H7
Grommets D18 F11-F12 G13

H

Hack Saw Frames and Blades H8
Halogen Bulbs B4-B5 B7
Headlamp Pigtails B15
Heat Gun C8
Heat Shrink Terminals A3 A6 G4
Heat Shrink Tubing C8 G4
Hex Nuts D5 D6 D7 D14 G8-G9
Hex Driver Bits H12 G14
High Temp Connectors A11
Hitch Pins D8-D9 G12
Hole Saws H8
Hole Terminals A7
Hook and Loop B17
Hook Terminals A10
Horn Buttons E7
Hose Clamps C9 G14

I

Ignition Connectors H14
Ignition Switches E7-E8
Insulated Clamps C9 G12

J

Jacketed Wire C3-C4
J-Case Fuses B11
Jigsaw Blades H9
Junction Blocks B11
Junction Boxes E10

K - L

Keys E9
LED Fuses B8
LED Lights F2-F4
License Plate Bolts D5
License Plate Brackets F13
License Plate Lights F10
Light Bars F4 F9
Light Brackets F10 F12-F13
Light Grommets F11-F12
Light Pigtails F11
Lights F2-F16
Lock Nuts D5 D7 D14
Lock Washers D4 D7 D14 G8-G9
Lubricants J3-J7 J9
Lynch Pins D10

M

Machine Nuts D5 D14
Machine Screws D11 D15 G11
Marker Lights F3-F4F7-F9
Masking Tape B17
Masks H3
Master Disconnect Switches E6
Maxi Fuses B8 G5
Mechanics Wire C10
Metal Boxes G16
Metric Bolts D7 G9
Metric-Pack Connectors A13 G2
Mini Fuses B8
Miniature Bulbs B2-B5
Mirror Adhesive J4
Mirrors F13

N

Nut and Bolt Assortments D6 G8-G9
Nut and Bolt Bins G9
Nuts D5 D7 D14 G8-G9
Nylon Ties A16-A17 G7

INDEX

O - P

Open Gear Lube	J7
Pack-Con Connectors	A13 G2
Paint Primer	J7
Paints	J7
Parallel Connectors	A10
Parallel Wire	C6
Pendant Station	E11
Penetrating Chemicals	J6 J9
Phillips Driver Bits	H12 G14
Piggy-Back Terminals	A7
Pigtails	B15 E11 F11
Pilot Lights	B15
Pin Terminals	A10
Pipe Fittings	K3
Pipe Thread Tape	B17
Plastic Boxes	G16
Plastic Clips	C10
Plastic Grommets	D18
Plow Lights	F14
Power cord	C7
Primary Wire	C2 G15
Push Button Switches	E6
Push-Pull Switches	E5

Q - R

Quick Disconnect Terminals	A6-A7 G3-G4 G12
Racks	G16
Receptacle Connectors	A7 G3
Reciprocating Blades	H9
Red Grease	J3
Reflective Tape	B17
Relays	B14
Ring Terminals	A4-A5 A9 A11 G3-G4 G12
Ripcord	C6
Rivets	D16-D17 G15
Rocker Switches	E5
Roll Pins	D10 G14
Roloc Discs	H4
Rough Service Bulbs	H13
Rubber Grommets	D18
Rubber Tie Downs	C10

S

Saw Blades	H7-H9
Scotch-Brite Pads	H5
Scotchloks	A15
Scratch Brushes	H6
Screws	D2-D3 D7 D11-D15 G10-G11
Sealed Beams	B6-B7
Seam Sealers	J8-J9
Sheet Metal Screws	D12 D15 G10
Shrink Tape	B16
Shrink Tube	G4

Shrink Tube Terminals	A2-A4 A6-A10 G4
Shut-Off Cocks	K4
Side Marker Lights	F3 F6-F8
Silicone Lubricants	J3 J5-J6 J9
Silicone Sealants	J2 J6 J8
SJOWW Wire	C7
Sleeved Clamps	C9
Slip Resistant Coating	J7
Snow Plow Lights	F14
Snowmobile Trailer Lights	F14
Solder	A9 G13
Solder Slugs	A9 G13
Solder Terminals	A9
Solenoid Switches	E9
Spade Terminals	A8 G3-G4
Spark Plug Wire and Ends	H14
Speaker Wire	C6
Split Loom	C7
Stainless Steel Fasteners	D14-D15 G10-G11
Star Terminals	A11
Starter Switches	E7-E8
Step-Down Butt Connectors	A3
Storage Bins and Boxes	G15-G16
Strobe Lights	F15-F16
Submersible Lights	F13
Super Glue	J4
Switches	E2-E10

T

Tail Lights	F2-F3 F5-F6 F13-F14
Taillight Converters	E11
Tape	B16-B17
Tarp Power Take-Off Switches	E15
Tarp Straps	C10
Tek Screws	D13 G11
Terminal Blocks	E10
Terminals	A1-A14 G2-G4
Terminal Extractor Tools	A12
Thread Sealants	B17 J3
Threaded Rod	D13
Thread-Serts	D17
Tie-Rap Tools	A16
Tie-Raps	A16-A17 G7
Toggle Switch Boots	E3
Toggle Switches	E2-E4 E10
Tool Cutting Oil	J7
Torx Driver Bits	H12 G14
Tow Lights	F13
Tractor Lights	F9
Trailer Adapters	E12
Trailer Cable	C3
Trailer Connector Accessories	E11-E14
Trailer Connectors	E11-E16
Trailer Harnesses	F14
Trailer Light Kits	F14
Trailer Plugs and Sockets	E12-E15
Trim Adhesives	J5

INDEX

T-Tap connectors	A15
Tubing	C7-C8
Turn Signal Lights	F2-F3 F5 F9
Twist-on Wire Connectors	A16

U

Undercoatings	J3 J5
U-Nuts	D5
Utility Knives and Blades	H3
Utility Lights	F4 F9

V

Vacuum Hose	C8
Vacuum Hose Fittings	G15
Velcro	B17

W - X - Y - Z

Washers	D4 G8-G9
Weather Pack Connectors	A12 G2
Weatherstrip Adhesives	J5
Welding Cable	C4
White Grease	J3 J5
Windshield Washer Hose	C8
Wing Nuts	D5
Wipes	J4
Wire	C2-C7 G12
Wire Cutters	H2
Wire Locking Pins	D10
Wire Storage	G15
Wire Strippers	H2
Wire Wheels and Brushes	H5-H6

QUICK INDEX SECTION A

A1

Terminals / Connectors / Scotchloks™ / Tie-Raps

- A2-3** Butt Connectors
- A4-5** Ring Terminals
- A6-7** Quick Disconnects
- A7** Bullets and Receptacles
- A8** Spade Terminals
- A9** Solder and Solder Terminals
- A10-11** Specialty Terminals
- A12** GM Weather Pack and Tools

- A13** GM Connectors
- A14** Deutsch DT Connectors
- A15** Scotchlok Connectors
- A16** Twist-on Wire Connectors
- A16** Cable Tie Installation Tool
- A17** Nylon Tie-Raps
- A18** Battery Terminals
- A19** Battery Accessories



A2

BUTT CONNECTORS

SEAMLESS

Seamless prevents any opening from stress or wire pull. May be crimped from any direction.

BUTTED SEAM

Basic style using a one-piece design. Copper is tamped, rolled and the seam is butted - the most economical style.

TERMINALS W/ SHRINK TUBING





























The adhesive lined heat shrink tubing provides a corrosion resistant crimp connection, improved mechanical performance and abrasion resistance.

PLASTIC INSULATED

Flared PVC insulation sleeve is permanently attached to the barrel. Funneled wire entrance eliminates wire strand "hang up".

NYLON INSULATED

Nylon insulation provides superior protection. The vibration shield strengthens barrel and secures wire to protect against stress and vibration. Moisture resistant are gel filled.

GAUGE	SEAMLESS	BUTTED SEAM	W/SHRINK TUBING	PLASTIC (PVC)	NYLON W/O Vibration Shield	NYLON Moisture Resistant	NYLON W/Vibration Shield
22 to 18 STD PKG	 A1B 100	 A3B 100	 A1B-ST A1B-ST-E ¹ 50	 A2B 100	 A4B 100	 A4B-WP 50	 A8B 100
16 to 14 STD PKG	 B1B 100	 B3B 100	 B1B-ST B1B-ST-E ¹ 50	 B2B 100	 B4B 100	 B4B-WP 50	 B8B 100
12 to 10 STD PKG	 C1B 100	 C3B 100	 C1B-ST C1B-ST-E ¹ 25	 C2B 100	 C4B 100	 C4B-WP 50	 C8B 100
8 STD PKG	 D1B 25		 D1B-ST 25	 D2B 25	 D4B 25	TIN PLATED. <i>Pictures shown not actual size. Ask about availability of additional sizes not shown.</i>	
6 STD PKG	 E1B ² 25			 E2B 25	 E4B 25	¹ Perma Seal ² Brazed Seam	







BUTT CONNECTORS

A3

GAUGE	SEAMLESS	GAUGE	SEAMLESS
4 STD PKG	 F1B ² 25	2 STD PKG	 G1B 10
1/0 STD PKG	 H1B 10	2/0 STD PKG	 J1B 10
3/0 STD PKG	 K1B 10	4/0 STD PKG	 L1B 10

² Brazed Seam

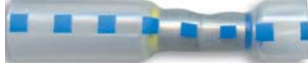
STEP-DOWN BUTT CONNECTORS

GAUGE	STEP-DOWN BUTT CONNECTOR	STEP-DOWN W/SHRINK TUBE	HYDRA-LINK STEP-DOWN
16-14 to 22-18 STD PKG	 B2BA Red Ring 25	 B2BA-ST Red Ring 25	 B2BAHL-ST Red Ring 10
12-10 to 16-14 STD PKG	 C2BB Blue Ring 25	 C2BB-ST Blue Ring 25	 C2BBHL-ST Blue Ring 10
8 to 12-10 STD PKG	 D2BC Yellow Ring 25	 D2BC-ST Yellow Ring 25	

Allows for connection of one wire size to another. Barrel color indicates the main wire size. The ring color indicates one size down.

Main wire size goes in here.  Step-Down wire size goes in here.

Colored ring

Toll Free: 800-922-6527 • Fax: 248-634-2022 • www.statewire.com

A4

RING TERMINALS

BRAZED SEAM

Bonded with a special silver brazing alloy to prevent seam opening from stress or wire pull. May be crimped from any direction.

TERMINALS W/ SHRINK TUBING

The adhesive lined heat shrink tubing provides a corrosion resistant crimp connection, improved mechanical performance and abrasion resistance.

PLASTIC INSULATED

Flared PVC insulation sleeve is permanently attached to the barrel. Funneled wire entrance eliminates wire strand "hang up".

NYLON INSULATED

Nylon insulation provides superior protection. The vibration shield strengthens barrel and secures wire to protect against stress and vibration.

GAUGE	STUD SIZE	STUD DIA.	BRAZED SEAM	w/SHRINK TUBING	PLASTIC (PVC)	NYLON w/Vibration Shield				
22 to 18	#6	.138								
	#8	.164					A1R-6	A1R-6ST	A2R-6	A4R-6
	#10	.190					A1R-8	A1R-8ST	A2R-8	A4R-8
	1/4	.250					A1R-10	A1R-10ST	A2R-10	A4R-10
	5/16	.312					A1R-14	A1R-14ST	A2R-14	A4R-14
	3/8	.375					A1R-56	A1R-56ST	A2R-56	A4R-56
STD PKG			A1R-38	A1R-38ST	A2R-38	A4R-38				
			100	25	100	100				
16 to 14	#6	.138								
	#8	.164					B1R-6	B1R-6ST	B2R-6	B4R-6
	#10	.190					B1R-8	B1R-8ST	B2R-8	B4R-8
	1/4	.250					B1R-10	B1R-10ST	B2R-10	B4R-10
	5/16	.312					B1R-14	B1R-14ST	B2R-14	B4R-14
	3/8	.375					B1R-56	B1R-56ST	B2R-56	B4R-56
1/2	.500	B1R-38	B1R-38ST	B2R-38	B4R-38					
STD PKG			B1R-12	B1R-12ST	B2R-12	B4R-12				
			100	25	100	100				
12 to 10	#6	.138								
	#8	.164					C1R-6	C1R-6ST	C2R-6	C4R-6
	#10	.190					C1R-8	C1R-8ST	C2R-8	C4R-8
	1/4	.250					C1R-10	C1R-10ST	C2R-10	C4R-10
	5/16	.312					C1R-14	C1R-14ST	C2R-14	C4R-14
	3/8	.375					C1R-56	C1R-56ST	C2R-56	C4R-56
1/2	.500	C1R-38	C1R-38ST	C2R-38	C4R-38					
STD PKG			C1R-12ST	C1R-12ST	C2R-12	C4R-12				
			100	25	100	100				
8	#10	.190								
	1/4	.250					D1R-10	D1R-10ST	D2R-10	D4R-10*
	5/16	.312					D1R-14	D1R-14ST		D4R-14*
	3/8	.375					D1R-56	D1R-56ST		D4R-56*
	3/8	.375					D1R-38	D1R-38ST		D4R-38*
	1/2	.500					D1R-12	D1R-12ST		D4R-12*
STD PKG			25	25	25	25				

TIN PLATED. Pictures not actual size.

Butted Seam Terminals are available upon request for 22-18GA & 16-14GA.

*** D4R series of Ring Terminals have NO vibration shield.**



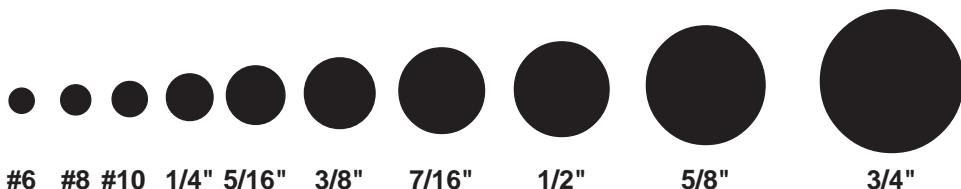







STUD SIZE CHART



State Wire and Terminal, Inc.

RING TERMINALS

A5

GAUGE	STUD SIZE	STUD DIA.	BRAZED SEAM	PLASTIC (PVC)	NYLON INSULATED			
6	#10	.190				E1R-10	E2R-56	E4R-10
	1/4	.250				E1R-14		E4R-14
5/16	.312	E1R-56				E4R-56		
3/8	.375	E1R-38				E4R-38		
1/2	.500	E1R-12				E4R-12		
STD PKG			25	25	25			
4	#10	.190				F1R-10	F2R-56 F2R-38	F4R-14
	1/4	.250				F1R-14		F4R-38
	5/16	.312				F1R-56		
	3/8	.375				F1R-38		
	1/2	.500				F1R-12		
STD PKG			25	25	25			
2	1/4	.250		<p>TIN PLATED. <i>Pictures not actual size. Call for availability of additional sizes not shown.</i></p>				
	5/16	.312						G1R-14
	3/8	.375						G1R-56
	1/2	.500						G1R-38
								G1R-12
STD PKG			10					
1/0	1/4	.250		2/0		H1R-14	J1R-56 J1R-38 J1R-12	
	5/16	.312				H1R-56		
	3/8	.375				H1R-38		
	1/2	.500				H1R-12		
	STD PKG							10
3/0	3/8	.375		4/0		K1R-38	L1R-38 L1R-12	
	1/2	.500				K1R-12		
	STD PKG							10

A6

QUICK DISCONNECTS

BUTTED SEAM

Basic style using a one-piece design. Brass is tamped, rolled and the seam is butted - the most economical style. Males are tinned copper. Females are tinned brass.

TERMINALS W/SHRINK TUBING

The adhesive lined heat shrink tubing provides a corrosion resistant crimp connection, improved mechanical performance and abrasion resistance.

PLASTIC INSULATED





























Flared PVC insulation sleeve is permanently attached to the barrel. Funneled wire entrance eliminates wire strand "hang up".

NYLON INSULATED

Extra sleeve strengthens barrel and secures wire to protect against stress and vibration. Nylon insulation provides superior protection.

NYLON FULLY INSULATED

Nylon insulation provides superior protection. No vibration shield.

GAUGE	TAB SIZE	BUTTED SEAM	W/SHRINK TUBING	PLASTIC (PVC)	NYLON w/VIBRATION SHIELD	NYLON FULLY INSULATED
22 to 18	.187 .250 .250 STD PKG	 A3FE-187 A3FE-250 100	 A6FE-250ST A6FE-250ST-3M 25	 A2FE-187 A2FE-250 100	 A4FE-187 A4FE-250 100	 A6FE-187-3M A6FE-250 A6FE-250-3M 100
	.187 .250 .250 STD PKG	 A3M-250 100	 A6M-250ST-3M 25	 A2M-250 100	 A4M-187 A4M-250 100	 A6M-187-3M A6M-250 A6M-250-3M 100
16 to 14	.187 .187 .250 .250 STD PKG	 B3FE-187 B3FE-250 100	 B6FE-187ST B6FE-250ST B6FE-250ST-3M 25	 B2FE-187 B2FE-187-E B2FE-250 100	 B4FE-187 B4FE-250 B4FE-250INS ¹ ¹ Fully Insulated 100	 B6FE-187 B6FE-187-3M B6FE-250 B6FE-250-3M 100
	.187 .250 .250 STD PKG	 B3M-250 100	 B6M-187ST B6M-250ST B6M-250ST-3M 25	 B2M-187 B2M-250 100	 B4M-187 B4M-250 B4M-250INS ¹ ¹ Fully Insulated 100	 B6M-187-3M B6M-250 B6M-250-3M 100
12 to 10	.250 .250 .375 STD PKG	 C3FE-250 C3FE-375 100	 C6FE-250ST 25	 C2FE-250 C2FE-375 100	 C4FE-250 C4FE-375 100	 C6FE-250-3M C6FE-250-E 100
	.250 STD PKG	TIN PLATED <i>Pictures are not actual size.</i>	 C6M-250ST 25	 C2M-250 100	 C4M-250 100	 C6M-250-3M 100

Difference between 3M Brand and ETC Molex ...



Double Hump - 3M®



3M Part# has -3M at the end.





Single Hump - ETC Molex



ETC Part# has -E at the end

TAB WIDTH CHART

	.187 INCHES
	.250 INCHES
	.375 INCHES

QUICK DISCONNECTS

A7

PIGGY-BACK STYLE				
GAUGE	TAB	PLASTIC (PVC)		NYLON w/Vibration Shield
22 to 18	.250			 A4FEM-250 100
	STD PKG			
16 to 14	.250	 B2FEM-250 100		 B4FEM-250 100
	STD PKG			

Pictures are not actual size. Ask about availability of additional sizes not shown.

<h3>ADAPTERS</h3> <p>Converts one power tab to two male tabs. Standard Package: 100</p> <table border="1"> <tr> <td style="text-align: center;"> PART#: MMFE  Tab Width: .250 </td> <td style="text-align: center;"> PART#: MMFEB  Tab Width: .250 </td> </tr> </table>	PART#: MMFE  Tab Width: .250	PART#: MMFEB  Tab Width: .250	<h3>INSULATED MALE TAB RECEPTACLE</h3> <p>PART# MMCO For connecting two .250 female disconnects. Standard Package: 50</p> 	<h3>HOLE TERMINALS WITH MALE TABS</h3> <p>PART# HO-10-250 Stude size: #10 & Tab: .250 Standard Package: 100</p> 
PART#: MMFE  Tab Width: .250	PART#: MMFEB  Tab Width: .250			

TERMINALS W/SHRINK TUBING

The adhesive lined heat shrink tubing provides a corrosion resistant crimp connection, improved mechanical performance and abrasion resistance.

PLASTIC INSULATED











Flared PVC insulation sleeve is permanently attached to the barrel. Funneled wire entrance eliminates wire strand "hang up".

NYLON INSULATED

Nylon insulation provides superior protection. The vibration shield strengthens barrel and secures wire to protect against stress and vibration.

FULLY INSULATED

Nylon insulation covers the connection protecting the crimped end as well as the mating area.

BULLETS					
GAUGE	DIA.	WITH SHRINK TUBE	PLASTIC (PVC)	NYLON w/VIBRATION SHIELD	NYLON FULLY INSULATED
22 to 18	.157 .180	 A1BU-ST 100		 A4BU A4BF 100	<i>Pictures are not actual size.</i>
		STD PKG			
16 to 14	.157 .180	 B1BU-ST B1BF-ST 100	 B2BU B2BF 100	 B4BU B4BF 100	
		STD PKG			
RECEPTACLES					
22 to 18	.157 .180	 A6FEB-ST 100	<i>Ask about availability of additional sizes not shown.</i>	 A4FEB-F 100	 A6FEB A6FEB-F 100
		STD PKG			
16 to 14	.157 .180	 B6FEB-ST 100		 B4FEB B4FEB-F 100	 B6FEB B6FEB-F 100
		STD PKG			

A8

SPADE TERMINALS

BRAZED SEAM

Bonded with a special silver brazing alloy to prevent seam opening from stress or wire pull. May be crimped from any direction.

TERMINALS W/ SHRINK TUBING

The adhesive lined heat shrink tubing provides a corrosion resistant crimp connection, improved mechanical performance and abrasion resistance.











PLASTIC INSULATED

Flared PVC insulation sleeve is permanently attached to the barrel. Funneled wire entrance eliminates wire strand "hang up".

NYLON INSULATED









Nylon insulation provides superior protection. The vibration shield strengthens barrel and secures wire to protect against stress and vibration.

STANDARD

GAUGE	STUD SIZE	STUD DIA.	BRAZED SEAM	w/SHRINK TUBING	PLASTIC (PVC)	NYLON w/Vibration Shield			
22 to 18	#6	.138	TIN PLATED. <i>Pictures are not actual size.</i>		A1S-6ST A1S-8ST A1S-10ST 25		A2S-6 A2S-8 A2S-10 100		A4S-6 A4S-8 A4S-10 100
	#8	.164							
#10	.190								
STD PKG									
16 to 14	#6	.138			B1S-6ST B1S-8ST B1S-10ST 25		B2S-6 B2S-8 B2S-10 100		B4S-6 B4S-8 B4S-10 100
	#8	.164							
	#10	.190							
	1/4	.250							
STD PKG			100						
12 to 10	#6	.138		C1S-6ST C1S-10ST 25		C2S-8 C2S-10 C2S-14 100		C4S-10 100	
	#8	.164							
	#10	.190							
	1/4	.250							
STD PKG									







FLANGED SPADES

LOCKING SPADES

GAUGE	STUD SIZE	STUD DIA.	PLASTIC (PVC)	NYLON w/Vibration Shield	PLASTIC (PVC)	NYLON w/Vibration Shield			
22 to 18	#6	.138				A2SF-6 A2SF-8 A2SF-10 100	A4SF-6 A4SF-8 A4SF-10 100	A2SL-6 A2SL-8 100	
	#8	.164							
	#10	.190							
STD PKG									
16 to 14	#6	.138				B2SF-6 B2SF-8 B2SF-10 100	B4SF-6 B4SF-8 B4SF-10 100	B2SL-6 B2SL-8 100	B4SL-6 B4SL-8 B4SL-10 100
	#8	.164							
	#10	.190							
STD PKG									
12 to 10	#6	.138				C2SF-6 C2SF-8 C2SF-10 100	C4SF-10 100	<i>Ask about availability of additional sizes not shown.</i>	C4SL-10 100
	#8	.164							
	#10	.190							
STD PKG									

State Wire and Terminal, Inc.

SOLDER TERMINALS AND SOLDER A9

GAUGE	STUD	RING TERMINAL	SOLDER ONLY BUTT CONNECTOR	CRIMP OR SOLDER BUTT CONNECTOR
22 to 18		<i>Call for availability of sizes not shown.</i>	 A1B-SLD	 A1B-SLD-CR
STD PKG			25	25
16 to 14	#10 1/4	 B1R-10SLD B1R-14SLD	 B1B-SLD	 B1B-SLD-CR
STD PKG		25	25	25
12 to 10		<i>Pictures are not actual size.</i>	 C1B-SLD	 C1B-SLD-CR
STD PKG			25	25

WIRE GAUGE CONVERSION CHART FOR PW & BC SERIES

AWG	INCHES	METRIC
22	.030"	.762 mm
20	.038"	.965 mm
18	.0475"	1.207 mm
16	.057"	1.45 mm
14	.071"	1.80 mm
12	.0925"	2.35 mm
10	.117"	2.97 mm
8	.144"	3.66 mm
6	.213"	5.41 mm
4	.257"	6.53 mm
2	.338"	8.59 mm

BULK SOLDER

For Electrical, Plumbing and General Purpose Needs



PART#	WIRE DIA	WEIGHT	TENSILE		
			STRENGTH (PSI)	MELT TEMP F°	MELT TEMP C°
60 TIN/40 LEAD ROSIN CORE (ELECTRICAL)					
SLD-11604	.062	1 lb.	6900	376°	190°
SLD-15604	.050	1 lb.	6900	376°	190°
SLD-11649	.125	1 lb.	6900	376°	190°
40 TIN/60 LEAD ACID CORE (ELECTRICAL)					
SLD-12406	.125	1 lb.	4900	460°	238°
FLO-TEMP LEAD FREE ROSIN CORE (PLUMBING)					
SLD-21945	.062	1/2 lb.	6400	430°	222°

SOLDER SLUGS



Solder Slugs are pre-measured pieces of flux-core solder that have been sized to provide the correct amount of solder for each size of cable connector. Assortment contains 10 each of 4, 1, 2, 1/0, 2/0 and 3/0 and is assembled in a sturdy 6-compartment plastic box (BX-PS06). Individual sizes sold 10 per package.

Check out Page G13 for more information on the Solder Slug Kit - **BTCR-SLUG-KIT60**

PART#	GAUGE	COLOR
BTCR-SLUG6	6	Gray
BTCR-SLUG4	4	Gray
BTCR-SLUG1	1	Pink
BTCR-SLUG2	2	Green
BTCR-SLUG1/0	1/0	Black
BTCR-SLUG2/0	2/0	Orange
BTCR-SLUG3/0	3/0	Purple
BTCR-SLUG4/0	4/0	Yellow

WATER SOLUBLE PASTE FLUX





PART#: SLD-51053

2 oz. Water soluble flux for non-electrical soldering of copper, brass, galvanized iron, steel, nickel alloys, nickel & tin plate. Use with solid wire solder and soldering iron or torch. Completely water washable. Easy cleaning. No Grit. Very active. Less corrosive. No Zinc Chloride. Meets ASTM B 813. Sold Individually.

A10

SPECIALTY TERMINALS

HOOK TERMINALS

GAUGE	STUD SIZE	STUD DIA.	NYLON w/Vibration Shield	
22 to 18	#6	.138		A4H-6
16 to 14	#8 #10	.164 .190		B4H-8 B4H-10

NYLON INSULATED CLOSED-END CONNECTORS

PART#	GAUGE
NPBA-S	22-20
NPBA	18-16
NPCB	16-14
NPCC	12-10



These nylon insulated closed-end connectors provide a fast, easy method of tying together or "pigtailling" solid or stranded wires. Insert stripped wires, crimp once and you have a secure connection. Nylon sleeve is permanently attached to metal insert. 600 volts maximum in building wire, 1000 volts maximum inside a sign or fixture.
Standard Package - 100

THREE-WAY			FOUR-WAY
B2Y	B4Y	C2Y	B4X
			
16-14 GA PLASTIC (PVC) STD PKG: 25	16-14 GA NYLON w/VIBRATION STD PKG: 25	12-10 GA PLASTIC (PVC) STD PKG: 25	16-14 GA NYLON w/VIBRATION STD PKG: 25

PIN TERMINALS		
A4PIN	B4PIN	C4PIN
		
22-18 GA NYLON w/VIBRATION SHIELD STD PKG: 100	16-14 GA NYLON w/VIBRATION SHIELD STD PKG: 100	12-10 GA NYLON w/VIBRATION SHIELD STD PKG: 100

Provides fast, easy connections in numerous applications - from the umbilical cord on a truck and trailer to a wide variety of terminal blocks. They are designed to provide excellent mechanical and electrical performance when secured under a set screw or pressure pads.

PARALLEL CONNECTORS

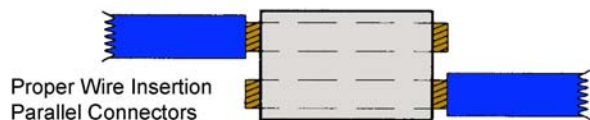

PART#	GAUGE	STD PKG
A1P	22-18	100
B1P	16-14	100
C1P	12-10	100



Pictures are not actual size.
Ask about the availability of additional sizes not shown.

HYDRA-LINK CLOSED END CONNECTOR WITH HEAT SHRINK

PART# NPCBHL-ST
Joins up to four wires.
Standard Package - 10

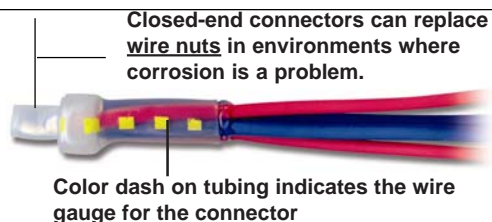







SPECIALTY TERMINALS

A11

HIGH TEMPERATURE TERMINALS

Steel with Nickel Plating. Rating: 900°F, 482°C continuous – 1200°F, 649°C intermittent. Butted Seam

GAUGE	STUD SIZE	STUD DIA.	RING TERMINAL	SPADE TERMINAL	QUICK DISCONNECT TERMINALS		
22 to 18 STD PKG	#10	.190	 A3R-10HT 100	 A3S-10HT 100			
16 to 14 STD PKG	#6 #10 1/4	.138 .190 .250	 B3R-6HT B3R-10HT B3R-14HT 100	 B3S-10HT 100	 B3FE-187HT B3FE-250HT 100	 B3M-187HT B3M-250HT 100	 B3FL-250HT 100
12 to 10 STD PKG	#6 #10	.138 .190	 C3R-6HT C3R-10HT 100				

STUD SIZE CHART



TAB WIDTH CHART



STAR RING TERMINAL



Blue Nylon with Vibration Shield.
Tinned Brass.

PART#	WIRE GAUGE	STUD SIZE
B4RS-10	16-14	#10

Standard Package - 100

AMP MATE-N-LOCK CONNECTORS



Fig 1

Fig 2

PART#	FIG	WIRE GAUGE
AMP-350705-2	1	20-14
AMP-350550-1	2	20-14

Standard Package - 100

FEMALE FLAG TERMINALS



Use CR-6 to crimp uninsulated flag connectors.

PART#	WIRE GAUGE	TAB SIZE
A1FL-187	22-18	.187
A1FL-250	22-18	.250
B1FL-187	16-14	.187
B1FL-250	16-14	.250

Standard Package - 100

NYLON INSULATED FEMALE FLAG TERMINALS

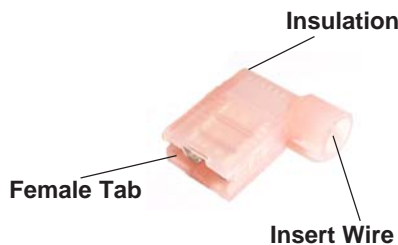

PART#	WIRE GAUGE	TAB SIZE	COLOR
A6FL-250	22-18	.250	Red
B6FL-250	16-14	.250	Blue
C6FL-250	12-10	.250	Yellow

This right angle nylon, fully insulated quick disconnect terminal provides space saving design.

Standard Package - 100

Pictures are not actual size. Ask about availability of additional sizes not shown.

Toll Free: 800-922-6527 • Fax: 248-634-2022 • www.statewire.com

A12 GM WEATHER PACK AND TOOLS

1-CAVITY GM-12015791	2-CAVITY GM-12015792	3-CAVITY GM-12015793	4-CAVITY GM-12015797	4-CAVITY GM-12015798	6-CAVITY GM-12015799
MALE SHELL STD PKG: 15 GM-12010996	MALE SHELL STD PKG: 15 GM-12010973	MALE SHELL STD PKG: 10 GM-12010717	MALE SHELL STD PKG: 10 GM-12010974	SQ. MALE TOWER STD PKG: 10 GM-12015024	MALE SHELL STD PKG: 10 GM-12010975
FEMALE SHELL STD PKG: 15	FEMALE SHELL STD PKG: 15	FEMALE SHELL STD PKG: 10	FEMALE SHELL STD PKG: 15	SQUARE FEMALE STD PKG: 10	FEMALE SHELL STD PKG: 10

22-20GA GM-12089679	18 GA GM-15324983	16-14 GA GM-12015323	14-12 GA GM-12048086	12 GA GM-12010293	10 GA GM-12015193	GM-12010300
CABLE SEAL PURPLE CABLE DIA: 1.6 - 2.15MM STD PKG: 25	CABLE SEAL RED CABLE DIA: 1.29 - 1.7MM STD PKG: 25	CABLE SEAL GREEN CABLE DIA: 2.03 - 2.85MM STD PKG: 25	CABLE SEAL RED CABLE DIA: 2.03 - 2.85MM STD PKG: 25	CABLE SEAL GRAY CABLE DIA: 2.81 - 3.49MM STD PKG: 25	CABLE SEAL BLUE CABLE DIA: 3.45 - 4.30MM STD PKG: 25	CAVITY PLUG GREEN STD PKG: 25

22 GA GM-12020801	20-18 GA GM-12089188	16-14 GA GM-12124580	12 GA GM-12124581
FEMALE TERMINAL STD PKG: 25	FEMALE TERMINAL STD PKG: 25 GM-12089040	FEMALE TERMINAL STD PKG: 25 GM-12124582	FEMALE TERMINAL STD PKG: 25 GM-12124587
<p>Pictures are not actual size. Ask about the availability of terminals not shown.</p>			
		MALE TERMINAL STD PKG: 25	MALE TERMINAL STD PKG: 25

WEATHER PACK & METRI-PACK EXTRACTOR PICK / RELEASE TOOL SET



PART# GM-0660T contains two Terminal Extractor Picks and one Terminal Release Tool. The Extractor Picks are used to release most GM, Ford and Chrysler OEM male and female blade terminals from their insulating shells. Not suitable for round, pin-type terminals. The Narrow Blade (Green Handle) tapers to a .050" width and the Wide Blade (Red Handle) tapers to a .090" width. The Weather Pack Terminal Release Tool (Yellow Handle) is designed to release the retaining tabs and easily remove Weather Pack socket and pin terminals from the connector bodies.
Standard Package : 1 / Set







WEATHER PACK CRIMPER



PART# AVC-16004 - Duplicates factory crimps on open barrel terminals used in automotive, computer and control applications. Features five machined and hardened crimp stations for 14 to 24 gauge wire terminations. Parallel jaws eliminate faulty crimps. Overall length 8-1/2".
Sold Individually.





GM CONNECTORS

A13

56 SERIES						
FEMALE TERMINAL 			MALE TERMINAL 		B3FEL-CO  FEMALE COVER STD PKG: 25	GM-12015306 FEMALE CUT OUT COVER STD PKG: 25 
B3FEL-250 16-14 GA 6.35MM UNPLATED STD PKG: 100	GM-02965142 16-14 GA 6.35MM TIN PLATED STD PKG: 25	GM-02989877 12 GA 6.35MM STD PKG: 15	B3ML-250 16-14 GA 6.35MM STD PKG: 100		GM-06294493  MALE COVER STD PKG: 25	GM-02973407 2-WAY FEMALE SHELL 6.35MM STD PKG: 15 





















METRI-PACK 150 SERIES					
GM-12048074  FEMALE SEALED 22-18GA 1.5MM STD PKG: 25	GM-12103881  FEMALE SEALED 18-16GA 1.5MM STD PKG: 25	GM-12110236  FEMALE 22-18GA 1.5MM STD PKG: 25	GM-12047767  FEMALE 22-16GA 1.5MM STD PKG: 25	GM-12047581  MALE BLADE 20-18GA 1.5MM STD PKG: 25	GM-12047665  METRI-PACK LOCKING CLIP STD PKG: 15

METRI-PACK 280 SERIES					
GM-12110846  FEMALE SEALED 22-20 GA 2.8MM STD PKG: 25	GM-12110847  FEMALE SEALED 18-16 GA 2.8MM STD PKG: 25	GM-12066214  FEMALE SEALED 16-14GA 2.8MM STD PKG: 25	GM-12129409  FEMALE SEALED 16-14 GA 2.8MM STD PKG: 25	GM-12110845  FEMALE SEALED 14-12 GA 2.8MM STD PKG: 25	GM-12110853  FEMALE SEALED 12-10 GA 2.8MM STD PKG: 25

METRI-PACK 280 SERIES			METRI-PACK 480 SERIES	
GM-12034046  FEMALE 20-16GA 2.8MM STD PKG: 25	GM-12034047  MALE BLADE 18-16GA 2.8MM STD PKG: 25	GM-12020116  MALE BLADE 14-12GA 2.8MM STD PKG: 25	GM-12124304  FEMALE 16-14 GA 4.8MM STD PKG: 25	GM-12020120  MALE BLADE 16-14 GA 4.8MM STD PKG: 25

Pictures are not actual size. Ask about the availability of terminals not shown.

METRI-PACK 630 SERIES		PACK-CON SERIES			
GM-12015870  FEMALE 16-14 GA 6.3MM STD PKG: 25	GM-12020126  MALE BLADE 16-14 GA 6.3MM STD PKG: 25	GM-06294511 MALE BLADE 20-18 GA 3.75MM STD PKG: 25 	GM-12020346 FEMALE 20-18 GA 3.75MM STD PKG: 25 	GM-12004572  4-WAY FEMALE TERMINAL 12-10 GA STD PKG: 25	GM-12004996  FEMALE SERIES II 16-14 GA 5.2 MM STD PKG: 25
		GM-12020320 MALE BLADE 16-14 GA 3.75MM STD PKG: 25	GM-12020347 FEMALE 16-14 GA 3.75MM STD PKG: 25		

	2-CONTACT	3-CONTACT	4-CONTACT	6-CONTACT	12-CONTACT
DEUTSCH PLUG - DT06 SERIES STD PKG: 10	PART# DE-DT06-2S 	PART# DE-DT06-3S 	PART# DE-DT06-4S 	PART# DE-DT06-6S 	PART# DE-DT06-12SA 
SECONDARY LOCK FOR DT06 PLUG - SERIES STD PKG: 10	PART# DE-W2S 	PART# DE-W3S 	PART# DE-W4S 	PART# DE-W6S 	PART# DE-W12S 
DEUTSCH SOCKET - DT04 SERIES STD PKG: 10	PART# DE-DT04-2P 	PART# DE-DT04-3P 	PART# DE-DT04-4P 	PART# DE-DT04-6P 	PART# DE-DT04-12PA 
SECONDARY LOCK FOR DT04 SOCKET - SERIES STD PKG: 10	PART# DE-W2P 	PART# DE-W3P 	PART# DE-W4P 	PART# DE-W6P 	PART# DE-W12P 

CONTACT REMOVAL TOOLS

Used on thin wall wire seals. Removes contact wire assembly out of connector. **Standard Package: 1**



PART#	GAUGE	COLOR
DE-0411-240-2005	20GA	Red
DE-0411-310-1605	16-18GA	Blue
DE-114010	12-14GA	White

SOLID PIN CONTACT (Male Terminal)



DE-0460-202-16141

DE-0460-215-16141

SOLID SOCKET CONTACT (Female Terminal)



DE-0462-201-16141

DE-0462-209-16141

The Deutsch contact is a solid, closed barrel, crimp type terminal, manufactured by a cold heading process using solid copper alloys for sizes 20, 16, and 12. The contact is interchangeable within the Deutsch DT family and is selected based upon the user's application. **Standard Package: 10**

PART#	DESCRIPTION	GAUGE
DE-0460-202-16141	Solid Pin Contact	16-20GA
DE-0460-215-16141	Solid Pin Contact	14-16GA
DE-0462-201-16141	Solid Socket Contact	16-20GA
DE-0462-209-16141	Solid Socket Contact	14-16GA

PALADIN TOOLS 4-WAY INDENT CONTACT CRIMPER



PART#: CR-PA1441 This crimp tool is designed for crimping solid barrel Deutsch contacts and D-subminiature contacts used with RS-232 interface connectors. Compact and spring loaded, this D-sub crimper features built-in locators that make alignment and subsequent crimping very fast and simple. Paladin 4-Way indent d-sub contact crimper crimps 20 to 12 AWG contacts. Tool measures 6.5" long.

UNIVERSAL HAND CRIMP TOOL



PART#: DE-HDT-48-00

Universal Hand Crimp Tool eight – indent, solid contacts. For size 20, 16 & 12 contacts. Wire range 24 – 12 AWG. For crimping loose pieces. **Sold Individually.**

SCOTCHLOK CONNECTORS A15



PART# SL-B3M (801): This insulated copper wire connector is designed for use on 14-18 AWG, and is capable of making tap, in-line and pigtail splices. UL listed for 300 volts on tap splices. *With plastic stop.* **100 per package**



PART# SL-Y3M (903): Designed exclusively for 10-12 gauge splicing on heavy-duty vehicle wiring. Tap, in-line and pigtail splices. UL listed for 300 volts on tap splices. **100 per package.**



PART# SL-W3M (564) : Designed for tap, in-line and pigtail splices in low voltage applications. It permits 4-way connections without cutting either wire. *No plastic stop.* **100 per package.**



PART# SL-BR3M (902): This heavy-duty connector is designed for 14, 16 and 18 gauge wire, connected to 10-12 gauge automotive wire. Ideal for over-the-road equipment where tap, in-line or pigtail splices are required. UL listed for 300 volts on tap splices. **100 per package.**



This handy connector is designed for quick electrical connections on pull-behind vehicles. It extends 14, 16 and 18 AWG to towed units with a universal or standard male bullet on .157" diameter. All you need is a pair of pliers. **100 per package.**

SL-BU3M (901)



SL-R3M (558)
22-18 to 22-18 Wire Range
UL Listed



SL-R3M-2 (557)
22-18 Pigtail Wire Range
UL Listed



SL-R3M-3 (905)
22-18 to 18-14 Wire Range
UL Listed



Pictures are not actual size.





Self-stripping connectors have productivity built in. No wasted time stripping or twisting wires. Reduced wire waste on the job. No special tools are needed - an ordinary pliers is all that is required. Make quick work of tap, in-line and pigtail connections. **100 per package.**

MOISTURE RESISTANT CONNECTOR



PART# SL-B3M-WP (804): *Sealant Filled.* The ease of Scotchlok™ installation with a protective gel around the wire and element. Provides a moisture-resistant barrier to destructive substances such as salt water and other corrosive environments. 18-14 gauge wire range. **50 per package.**

BUTTON-STYLE CONNECTORS

SL-UR (UR2)
3 Port

Trim, straighten conductors

Separate, fully insert conductors

Crimp with cap side down

SL-314 (314)
3 Port

Sealant provides moisture resistant connection.

PART#	GAUGE	PKG	COLOR
SL-UR	26-19	100	Red
SL-314	22-14	25	Blue

T-TAP CONNECTORS



SL-A3M-FE (951K)
22-18 GA
Mates with
A6M-250-3M



SL-B3M-FE (952K)
18-14 GA
Mates with
B6M-250-3M



SL-C3M-FE (953K)
12 GA
Mates with
C6M-250-3M

T-TAP Connectors speed installation, reduce conductor damage and make fast work of otherwise time consuming mid-span taps. A tap leg that can be disconnected simplifies hookup and increases flexibility. It provides a fully-insulated connection when used with a fully-insulated male quick-slide terminal. Mates with most .250" male blades. **Available in 100 or 1,000 packages.**

A16 TWIST-ON WIRE CONNECTORS

HARD PLASTIC

600 Volts maximum: building wiring, signs. 105°C. Resistant to heat, cold, moisture, friction and abrasion.

WING LOCK WIRE CONNECTORS

Durable shell is chemical, impact and heat resistant plastic. Built-in wings designed for no-slip and easy installation. Expandable square wire ring snares wire. No pretwisting needed. Deep wide skirt for easy wire insertion and resistance against electrical flash.

	HARD PLASTIC					HARD PLASTIC		
	WN-71B	WN-72B	WN-73B	WN-74B	WN-76B	WN-74W	WN-76W	WN-78W
								
COLOR	Gray	Blue	Orange	Yellow	Red	Yellow	Red	Blue
MIN	2 #22	3 #20	2 #18	2 #18	3 #18	2 #18	2 #16	3 #12
MAX	2 #16	3 #16	2 #14	2 #14	3 #10	3 #12	5 #12	1 #6
VOLT	300V	300V	600V	600V	600V	600V	600V	600V
TEMP	105°C	105°C	105°C	105°C	105°C	105°C	105°C	105°C
STYLE	Standard	Standard	Standard	Standard	Standard	Winged	Winged	Winged
STD PKG	100	100	100	100	100	100	100	100

TIE-RAP MOUNTING BASES



PART# GCNT-W

White, nylon, rigid, stick on or screw mount. For 50 lbs TS or less. 1" Square (one inch).

Standard Package 100.

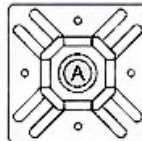

CABLE TIE INSTALLATION TOOL



PART# NT-GUN

Lightweight, hand-operated cable tying tool with four position setting. Obtains uniform, preset tension and flush cut-off every time, regardless of your application. After the cable tie is threaded and drawn snug, simply insert it in the tool and squeeze the trigger. The tool automatically adjusts to the preset tension, cuts the cable tie flush, rejects the cut-off portion without any sharp edges. Good for cable ties up to 50 LBS Tensile Strength (Pounds per square inch.)

COLORED NYLON TIE-RAPS



PART#	COLOR	LENGTH	WIDTH	TS*	STD PKG
NT-7BLU	Blue	7-1/2"	.190"	50	100
NT-7GRN	Green	7-1/2"	.190"	50	100
NT-7ORG	Orange	7-1/2"	.190"	50	100
NT-7PNK	Pink	7-1/2"	.190"	50	100
NT-7YEL	Yellow	7-1/2"	.190"	50	100

Used for identifying wires, hoses, bundles and departments. They blend with the new bright colors on boats, snowmobiles, jet skis and 4-wheelers. *Tensile strength (pounds per square inch).

Check out [Page G7](#) for more information on the Colored Nylon Tie-Rap Assortment [NT-KIT600C](#)















Pictures are not actual size.

State Wire and Terminal, Inc.

NYLON TIE-RAPS

A17

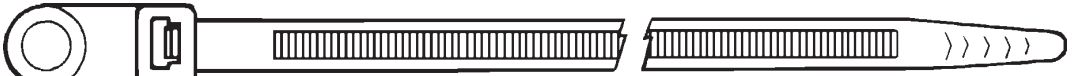
All nylon construction in white or ultraviolet resistant black which is recommended for outdoor use when ties are exposed to sunlight. Discounts available at 500 and 1000 pieces. *Tensile Strength (Pounds per square inch.) ROHS Compliant.

TYPE	WHITE PART#	BLACK PART#	LENGTH	TS*	WIDTH	THICKNESS	MAX BUNDLE	STD PKG
								
LIGHT DUTY	NT-4	NT-B4	4.12"	18	.095	.042	.875	100
								
STANDARD DUTY	NT-6	NT-B6	5.84"	40	.140	.049	1.437	100
	NT-7L	NT-B7L	8.875"	40	.140	.049	2.375	100
	NT-7	NT-B7	7.56"	50	.180	.052	1.875	100
	NT-11	NT-B11	11.25"	50	.180	.052	3.062	100
	NT-14	NT-B14	14.25"	50	.180	.052	4	100
								
CURVED HEAD		NT-B7FCT	8"	50	.190	.052	1.77	100
								
HEAVY DUTY	NT-7HD	NT-B7HD	8.70"	120	.300	.076	2.06	100
	NT-14HD	NT-B14HD	15.09"	120	.300	.076	4.06	100
	NT-24HD	NT-B24HD	25.25"	175	.340	.090	7.18	50
	NT-36HD	NT-B36HD	37.25"	175	.340	.090	11.00	50
								
TREE MOUNT TIES		NT-B7X	8.42"	50	.185	.063	2	100
								
STANDARD DUTY W/MOUNTING HOLE	NT-H7	NT-BH7	8"	50	.177	0.52	1.75	100
	NT-H11	NT-BH11	11.5"	50	.177	0.53	3	100
	NT-H14		14.5"	50	.177	0.53	4	100
								
HEAVY DUTY W/ MOUNTING HOLE	NT-H14HD	NT-BH14HD	15.7"	120	.298	0.75	4.06	100
								
BUTTON TIES		NTBH-B9	9.63"	105	.220	0.06	2.62	50

Toll Free: 800-922-6527 • Fax: 248-634-2022 • www.statewire.com

A18 BATTERY TERMINALS & ACCESORIES

Removable Plate for Easy Assembly
 Fits Positive or Negative Posts
 Threaded Clamp Avoids Pull-Out
 Lead Alloy
 Steel Inserts Avoid Stripping
 Bolt Locks Firmly from Left to Right Side
 Universal - Holds Cable and Strap

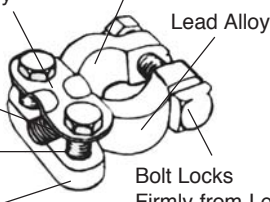

UNIVERSAL EMERGENCY TYPE



LEAD SIDE MOUNT



PART#	TYPE	GAUGE	STD PKG	CASE
BTE	Card	8 to 1	10 / Card	10 Cards / Case
BTE-B	Bulk	8 to 1	10 / Bag	100 / Case
BTE-HD	Card	1/0 to 3/0	10 / Card	6 Cards / Case
BTE-HD-B	Bulk	1/0 to 3/0	5 / Bag	60 / Case

PART# BTE-S
 Packaged 8 / Card
 10 Cards / Case



MARINE TYPE

Perfect for Marine Display

TYPE	PART #	STUD	TYPE	PKG
LEAD	MBT	5/16"	Universal	10/Card 10 Cards/Case
	MBT-P&N	3/8"	Positive	1 Pair/Card
		5/16"	Negative	24 Cards/Case

LEAD MILITARY TYPE



PART #	TYPE
BTMI-N	Negative
BTMI-P	Positive

For Diesel Truck Application with Parallel Batteries.
 Sold Individually

CHARGING POSTS





PART# EP-31CP
 For 3/8" Stud Type Battery Terminal - Converts 3/8" stud to standard post type. Used as an adapter to group hook-up batteries or to convert stud type commercial batteries for use with post type battery cables. **Standard Package - 10**







LEAD CHARGING POSTS for Batteries



PART# EP-STCP2J
 Set - one positive, one negative, greatly facilitate charging of side terminal batteries. Posts have 3/8" threaded stud to screw into side terminal batteries for easy charging. **Standard Package - 1 Pair Carded.**

SIDE BOLT BATTERY MOUNT		SIDE MOUNT BATTERY BOLT		BATTERY NUT AND BOLTS	
EP-828		EP-828L		EP-999B	
13/32" Length 3/8" original equipment terminal bolt. Standard Package - 10		1" Length 3/8" original equipment terminal bolt. Standard Package - 10		To replace original equipment with side mount battery terminals. 3/8 Thread Standard Package - 10	
				BNB-1/4	
				1/4" Dia. 1-1/4" Length Standard Package - 100	BNS-WS
					5/16" Dia. 1-3/8" Length. Has hex nut with shoulder for easy tightening. Standard Package - 50

BATTERY ACCESSORY BOLT	SIDE MOUNT BATTERY ADAPTER	SPACER FOR SIDEMOUNT BATTERY	BATTERY POST CLEANER
SMA-5/16L	SMA-5/16	EP-SM-SPACER	BPC
			
3/8x1 bolt with 5/16-18 x 1/2 stud. Connect accessories directly to your battery. Ideal for radios, lights, winches, stereo systems and hydraulic pumps - any accessory that requires direct connection to the battery. Includes nut and washer. Standard Package - 5	3/8x3/8 bolt with 5/16-18 x 1/2 stud. Connect accessories directly to your battery. Ideal for radios, lights, winches, stereo systems and hydraulic pumps - any accessory that requires direct connection to the battery. Includes nut and washer. Standard Package - 5	Lead Spacer for Side Terminal Bolt. I.D. 3/8" For dual cable hook-up on side terminal batteries. Standard Package - 10	Pocket size tool - Metal brush shaped to fit inside the terminals. Will quickly remove all corrosion with a few turns. Special wire brush in base of tool fits over the Battery Post for cleaning and shaping the post. A few turns and the post is like new. Sold Individually

BATTERY TERMINALS & ACCESORIES A19

FOR ALL HEAVY DUTY APPLICATIONS

**TRUCKS, BUSES, LIFT TRUCKS,
PLANT MAINTENANCE, MARINE,
STATIONARY ENGINES,
OFF ROAD EQUIPMENT**

Die Cast Copper. **Crimp or solder on.** Extremely high conductivity. 95% pure copper, less than 1% lead. Copper is 70% more conductive than lead. Delivers more electricity under load. Furnished with nut & bolt. Coated with a tin plating. Plating permits higher conductivity than lead. All terminals show wire range and whether positive or negative. Post holes are tailored for exact fit against the post. **Standard Package - 5**



PART#	COLOR	GAUGE	STYLE
BTCR-4U	Green	4	Universal
BTCR-4P	Green	4	Positive
BTCR-4N	Green	4	Negative
BTCR-1&2P	Pink	1 and 2	Positive
BTCR-1&2N	Pink	1 and 2	Negative
BTCR-1/0P	Black	1/0	Positive
BTCR-1/0N	Black	1/0	Negative
BTCR-2/0P	Orange	2/0	Positive
BTCR-2/0N	Orange	2/0	Negative
BTCR-3/0P	Purple	3/0	Positive
BTCR-3/0N	Purple	3/0	Negative
BTCR-4/0P	Yellow	4/0	Positive
BTCR-4/0N	Yellow	4/0	Negative

BATTERY NUT



PART# BTCRFB-NUT
Closed top Stainless Steel
3/8-16" thread and 9/16"
hex head. **5 Per Package**

90° RIGHT ANGLE TYPE



NEW LONGER BARREL.

Can also be soldered. **5 Per Package**

PART#	GAUGE	STYLE
BTCR90-1/0P	1/0 P	Positive
BTCR90-1/0N	1/0 N	Negative
BTCR90-2/0P	2/0 P	Positive
BTCR90-2/0N	2/0 N	Negative

COPPER BATTERY LUGS

Made from seamless copper tube. Ideal for general wiring, starter or ground connections. can be crimped or soldered. UL approved. Made in USA.

STANDARD

GAUGE	1/4 STUD	5/16 STUD	3/8 STUD	1/2 STUD	STD PKG
8			BTC-838		10
6	BTC-614	BTC-656	BTC-638		10
4	BTC-414	BTC-456	BTC-438		10
2	BTC-214	BTC-256	BTC-238	BTC-212	10
1		BTC-156	BTC-138		10
1/0		BTC-1056	BTC-1038	BTC-1012	5
2/0		BTC-2056	BTC-2038	BTC-2012	5
3/0			BTC-3038	BTC-3012	5
4/0			BTC-4038	BTC-4012	5



HEAVY DUTY MAGNA LUGS - Plated

GAUGE	COLOR	5/16 STUD	3/8 STUD	1/2 STUD	STD PKG
4	Gray	BTC-P456	BTC-P438		5
1&2	Pink	BTC-P1&256	BTC-P1&238	BTC-P1&212	5
1/0	Black		BTC-P1038	BTC-P1012	5
2/0	Orange		BTC-P2038	BTC-P2012	5
3/0	Purple		BTC-P3038	BTC-P3012	5
4/0	Yellow		BTC-P4038	BTC-P4012	5



ANDERSON CONNECTORS



**PROTECTIVE
CAP**

All Anderson housings are color-keyed. This means housings will mate only with **same colored** housings. The color-key feature makes it possible for you to differentiate voltages of your electrical circuits. For example, you don't want to plug a 36-volt battery pack into a 48-volt charger. Color-keying your wiring will help to prevent expensive and dangerous damage. Gray housings are by far the most commonly used color. People who have only one voltage in their work environment tend to use gray housings no matter what that voltage is.

PART#	GAUGE	AMPS	STYLE	STD PKG
AC-123101	10-12ga	50	Terminal	2
AC-123103	6ga	50	Terminal	1
AC-123104	4ga	175	Terminal	2
AC-123105	2ga	175	Terminal	2
AC-123107	1/0ga	175	Terminal	2
AC-123108	2/0ga	350	Terminal	2
AC-122101		50	Gray Housing - 36 Volts	1
AC-122104		175	Gray Housing - 36 Volts	1
AC-122108		350	Gray Housing - 36 Volts	1
AC-122204		175	Red Housing - 24 Volts	1
AC-122304		175	Blue Housing - 48 Volts	1
AC-126402		175	Black Protection Cap	1
AC-126403		350	Black Protection Cap	1
AC-124103	6ga	50	Connector Kit (Gray) ¹	1
AC-124204	4ga	175	Connector Kit (Red) ¹	1
AC-125105	2-4ga	175	Anderson Fusion Connector Kit ²	1
AC-120101			Anderson Safety Glasses	10

¹ Includes 1 Housing and 2 Terminals

² Includes Built in Solder

Toll Free: 800-922-6527 • Fax: 248-634-2022 • www.statewire.com

NOTES

QUICK INDEX SECTION B

B1

Miniature Bulbs / Sealed Beams / Fuse Products / Tape

- B2-5** Miniature Bulbs and Halogen Capsules
- B6** Sealed Beams
- B7** Halogen Sealed Beams
- B8** Blade Fuses
- B9** Blade Fuse Holders
- B10** Glass Fuses and Holders

- B11** Glass Fuse Products
- B12** Circuit Breakers
- B13** Flashers
- B14** Relays
- B15** Automotive Pigtails
- B16-17** Tapes

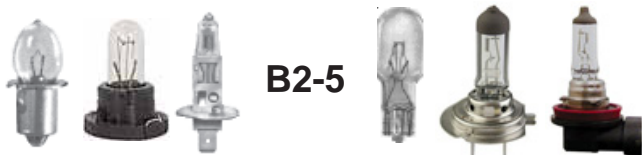

B2-5



B11



B6



B12

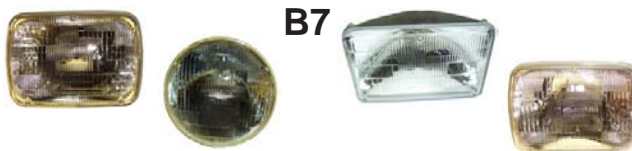

B7



B13

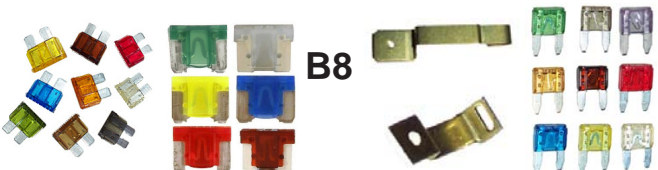

B8



B14

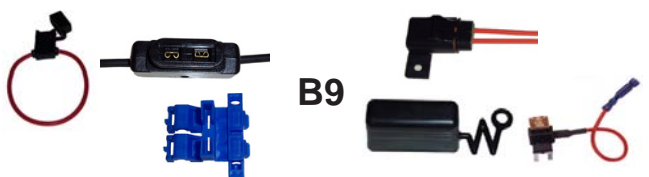

B9

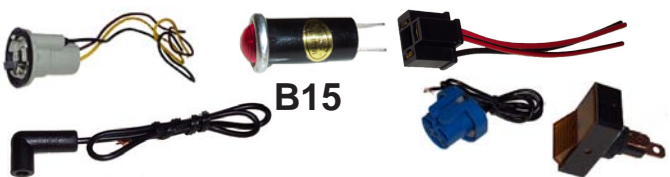

B15



B10







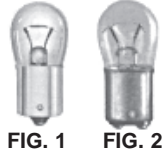

B16-17

B2

MINIATURE BULBS

Selection of proper lighting involves far more than merely picking a lamp type. The proposed use of the light must be considered in relation to various other factors: light quantity, space, power source, strength, life and temperature. Our full-line of bulbs will fit your needs.

TYPE B-3-1/2 	ECONOMY			BASE TYPE	VOLTS	AMPS	MOL ²	AVERAGE LIFE HRS	APPROX C.P. ¹
	PART#	PART#	FIG						
	W-PR2	J-PR2		Single Contact Mini Flange	2.38	0.50	1.250	15	0.80
	W-PR3			Single Contact Mini Flange	3.57	0.50	1.250	15	1.50
	W-PR7			Single Contact Mini Flange	3.70	0.30	1.250	30	0.90
	W-PR13			Single Contact Mini Flange	4.75	0.50	1.250	15	2.20
	W-PR18			Single Contact Mini Flange	7.20	0.55	1.250	3	4.80
TYPE B-6  FIG. 1 FIG. 2	W-105	J-105	1	Single Contact Bayonet	12.80	1.00	1.750	600	12.00
	W-1003	J-1003	1	Single Contact Bayonet	12.80	0.94	1.750	100	15.00
	W-1004	J-1004	2	Double Contact Bayonet	12.80	0.94	1.750	100	15.00
TYPE G-3-1/2  FIG. 3 FIG. 4	W-1449		3	Minature Screw	14.00	0.20	0.938	250	2.00
		J-51	4	Minature Bayonet	7.50	0.22	0.938	1000	1.00
	W-53	J-53	4	Minature Bayonet	14.40	0.12	0.938	1000	1.00
	W-356		4	Minature Bayonet	28.00	0.17	0.938	500	3.50
TYPE G-4-1/2 	W-57	J-57		Minature Bayonet	14.00	0.24	1.063	500	2.00
	W-1895	J-1895		Minature Bayonet	14.00	0.27	1.063	1500	2.00
TYPE G-6  FIG. 5 FIG. 6	W-63	J-63	5	Single Contact Bayonet	7.00	0.63	1.438	1000	3.00
	W-67	J-67	5	Single Contact Bayonet	13.50	0.59	1.438	5000	4.00
	W-89	J-89	5	Single Contact Bayonet	13.00	0.58	1.438	750	6.00
	W-97 ⁴		5	Single Contact Bayonet	13.50	0.69	1.438	5000	4.00
	W-98		5	Single Contact Bayonet	13.00	0.62	1.438	1300	6.00
	W-623		5	Single Contact Bayonet	28.00	0.37	1.438	1000	6.00
	W-1155 ³		5	Single Contact Bayonet	13.50	0.59	1.438	5000	4.00
	W-1251		5	Single Contact Bayonet	28.00	0.23	1.438	1000	3.00
	W-68		6	Double Contact Bayonet	13.50	0.59	1.438	5000	4.00
	W-90	J-90	6	Double Contact Bayonet	13.00	0.58	1.438	750	6.00
TYPE GT-8  FIG. 7  FIG. 8	W-3156	J-3156	7	Single Contact Wedge	12.80	2.10	2.120	1200	32.00
	W-3057	J-3057	8	Double Contact Wedge	12.80	2.10	2.120	1200	32.00
					14.00	0.48		5000	2.00
	W-3057NA		8	Double Contact Wedge	12.80	2.10	2.120	1200	24.00
					14.00	0.48		5000	2.00
	W-3157	J-3157	8	Double Contact Wedge	12.80	2.10	2.120	1200	32.00
					14.00	0.59		5000	3.00
	W-3157NA		8	Double Contact Wedge	12.80	2.10	2.120	1200	24.00
					14.00	0.59		5000	2.20
	W-3357		8	Double Contact Wedge	12.80	2.23	2.120	400	40.00
					14.00	0.59		5000	3.00
	W-4114LL ⁶		8	Double Contact Wedge	14.00	2.23	2.134	4000	32.00
					14.00	0.59		10,000	3.00
	W-4157LL ⁶		8	Double Contact Wedge	12.80	2.10	2.120	3600	32.00
					14.00	0.59		10,000	3.00
TYPE RP-11  FIG. 9 FIG. 10	W-1195		9	Single Contact Bayonet	12.50	3.00	1.250	300	50.00
	W-1196		10	Double Contact Bayonet	12.50	3.00	1.250	300	50.00
<i>Pictures are not actual size. Ask about availability of additional types and sizes not shown.</i>									











¹Approximate Candle Power. ² Maximum Overall Length. ³ Dual Filament. ⁴ Fleet Duty Bulb. ⁵ Halogen Bulb ⁶ Long Life

⁷ Bright Light

State Wire and Terminal, Inc.

MINIATURE BULBS

B3





















TYPE S-8	ECONOMY			BASE TYPE	VOLTS	AMPS	MOL ²	AVERAGE LIFE HRS	APPROX C.P. ¹	
	PART#	PART#	FIG							
 FIG. 11	W-93		11	Single Contact Bayonet	12.80	1.04	2.000	500	15.00	
	W-199 ⁴		11	Single Contact Bayonet	12.80	2.25	2.000	1200	32.00	
	W-1073	J-1073	11	Single Contact Bayonet	12.80	1.80	2.000	200	32.00	
	W-1129		11	Single Contact Bayonet	6.40	2.63	2.000	200	21.00	
	W-1141	J-1141	11	Single Contact Bayonet	12.80	1.44	2.000	500	21.00	
	W-1156	J-1156	11	Single Contact Bayonet	12.80	2.10	2.000	1200	32.00	
	W-1156NA		11	Single Contact Bayonet	12.80	2.10	2.000	1200	24.00	
	W-1203		11	Single Contact Bayonet	28.00	0.71	2.000	400	21.00	
	W-1683	J-1683	11	Single Contact Bayonet	28.00	1.02	2.000	500	32.00	
	W-94		12	Double Contact Bayonet	12.80	1.04	2.000	500	15.00	
 FIG. 12	W-1076	J-1076	12	Double Contact Bayonet	12.80	1.80	2.000	200	32.00	
	W-1142	J-1142	12	Double Contact Bayonet	12.80	1.44	2.000	500	21.00	
	W-1156DC		12	Double Contact Bayonet	12.80	2.10	2.000	1200	32.00	
	W-1176	J-1176	12	Double Contact Bayonet	12.80	1.34	2.000	200	21.00	
					14.00	0.59		1000	6.00	
	W-198 ⁴	J-198 ⁴	13	Double Contact Index	12.80	2.25	2.000	1200	32.00	
					14.00	0.59		5000	3.00	
	W-1034		13	Double Contact Index	12.80	1.80	2.000	200	32.00	
					14.00	0.59		5000	3.00	
	W-1154	J-1154	13	Double Contact Index	6.40	2.63	2.000	200	21.00	
 FIG. 13	W-1157	J-1157	13	Double Contact Index	7.00	0.75	2.000	1000	3.00	
					12.80	2.10	2.000	1200	32.00	
					14.00	0.59		5000	3.00	
	W-1157NA	J-1157NA	13	Double Contact Index	12.80	2.10	2.000	1200	24.00	
					14.00	0.59		5000	2.20	
	W-1662	J-1662	13	Double Contact Index	28.00	0.93	2.000	400	32.00	
					28.00	0.34		1000	6.00	
	W-2057	J-2057	13	Double Contact Index	12.80	2.10	2.000	1200	32.00	
					14.00	0.49		5000	2.00	
	W-2057NA		13	Double Contact Index	12.80	2.10	2.000	1200	24.00	
	W-2357		13	Double Contact Index	14.00	0.49		5000	1.50	
					12.80	2.23	2.000	400	40.00	
					14.00	0.59		5000	3.00	
	W-2357NA		13	Double Contact Index	12.80	2.23	2.000	400	30.00	
					14.00	0.59		5000	2.25	
	TYPE T-1-3/4									
	  FIG. 14 FIG. 15	W-37		14	Wedge	14.00	0.09	0.800	2500	0.50
			J-70	14	Wedge	14.00	0.15	0.800	100	1.50
		W-73		14	Wedge	14.00	0.08	0.800	15000	0.30
		W-74		14	Wedge	14.00	0.10	0.800	1000	0.70
		J-85	14	Wedge	28.00	0.04	0.800	10000	0.30	
		J-86	14	Wedge	6.30	0.20	0.800	20000	0.40	
W-327			15	Single Cont. Midget Flanged	28.00	0.04	0.625	4000	0.33	
W-330			15	Single Cont. Midget Flanged	14.00	0.08	0.625	750	0.50	
		J-382	15	Single Cont. Midget Flanged	14.00	0.08	0.625	50000	0.30	
		J-NWE73	16	NeoWedge (Black Base)	14.00	0.08		10000	0.30	
  FIG. 16 FIG. 17	W-PC74		17	Printed Circuit	14.00	0.10	0.842	1000	0.70	
	W-11009		18	BA75mm (12V1.5W)	14.40	0.12	0.748	500	1.00	
 FIG. 18										
	TYPE T-2-1/4									
	   FIG. 19 FIG. 20 FIG. 21		J-3898	19	B47S	12.00	0.17		200	
W-11006			20	5v7mm (12V 5W)	14.00	0.24	1.102	1000	2.00	
W-891 ⁵			21	G-4 Two Pin	12.80	1.25	1.000	500	11.00	
<p><i>Pictures are not actual size.</i></p> <p><i>Ask about availability of additional types and sizes not shown.</i></p>										

¹Approximate Candle Power. ² Maximum Overall Length. ³ Dual Filament. ⁴ Fleet Duty Bulb. ⁵ Halogen Bulb ⁶ Long Life

⁷ Bright Light

B4

MINIATURE BULBS

TYPE T-2-1/2	ECONOMY		FIG	BASE TYPE	VOLTS	AMPS	MOL ²	AVERAGE LIFE HRS	APPROX C.P. ¹
	PART#	PART#							
 H1 Type	W-1255/H1 ⁵	J-1255/H1 ⁵		P14.5s (55 watts)	12.00	4.58	2.430	300	129.00
	W-1210/H1 ⁵	J-1210/H1 ⁵		P14.5s (100 watts)	12.00	8.33	2.430	50	217.00
 TYPE T-2-3/4	W-24NA			Wedge	14.00	0.24	0.860	1500	1.50
	W-24			Wedge	14.00	0.24	0.860	1500	2.00
   TYPE T-3 FIG. 22	W-222		22	Miniature Screw	2.25	0.25	0.940	5	--
	W-211-2		23	Double End Cap	12.80	0.97	1.720	1000	12.00
	W-212-2		23	Double End Cap	13.50	0.74	1.720	5000	6.00
	W-561		24	Rigid Loop	12.80	0.97	1.720	1000	12.00
   TYPE T-3-1/4 FIG. 25 FIG. 26    FIG. 27 FIG. 28    FIG. 29 FIG. 30    FIG. 31 FIG. 32    FIG. 33 FIG. 34	W-44		25	Miniature Bayonet	6.30	0.25	1.188	3000	0.90
	W-756		25	Miniature Bayonet	14.00	0.08	1.188	50000	0.31
	W-1813		25	Miniature Bayonet	14.40	0.10	1.188	1000	0.86
		J-1816	25	Miniature Bayonet	13.00	0.33	1.188	1000	3.00
	W-1819		25	Miniature Bayonet	28.00	0.04	1.188	1000	0.34
	W-1847		25	Miniature Bayonet	6.30	0.15	1.188	20000	0.38
	W-1864		25	Miniature Bayonet	28.00	0.17	1.188	1500	3.00
	W-1889	J-1889	25	Miniature Bayonet	14.00	0.27	1.188	1500	2.00
	W-1891		25	Miniature Bayonet	14.00	0.24	1.188	500	2.00
	W-1893	J-1893	25	Miniature Bayonet	14.00	0.33	1.188	2000+	2.00
	W-12100		26	SV8.5mm (10 Watts)	13.00	0.77	1.221	400	9.55
	W-158		27	Wedge	14.00	0.24	1.052	500	2.00
	W-161		27	Wedge	14.00	0.19	1.052	4000	1.00
	W-168		27	Wedge	14.00	0.35	1.060	1500	3.00
	W-193		27	Wedge	14.00	0.33	1.052	15000	2.00
	W-194	J-194	27	Wedge	14.00	0.27	1.052	2500	2.00
	W-194NA		27	Wedge	14.00	0.27	1.052	2500	1.50
	W-PC194		28	Printed Circuit	14.00	0.27	1.110	4000	2.00
	W-880 ⁵		29	Axial Prefocus	12.80	2.10	2.680	300	43.00
	W-881 ⁵		30	Right Angle Plastic Prefocus	12.80	2.10	2.680	300	43.00
	W-890 ⁵		31	Axial Plastic	12.80	2.10	2.680	300	43.00
	W-886 ⁵		32	Right Angle Prefocus	12.80	3.90	2.680	200	100.00
		J-888 ⁵	32	Right Angle Prefocus	12.80	3.90	2.680	400	95.00
	W-889 ⁵		32	Right Angle Plastic	12.80	3.90	2.680	300	43.00
	W-894 ⁵		32	Right Angle Plastic	12.80	2.93	2.680	200	75.00
	W-1237/H1 ⁵		33	Type H1 Halogen (37.5 watts)	12.80	2.93	1.330	200	75.00
	W-1210/H3 ⁵	J-1210/H3 ⁵	34	Type H3 Halogen (100 watts)	12.00	4.58	1.650	50	121.00
W-1255/H3 ⁵	J-1255/H3 ⁵	34	Type H3 Halogen (55 watts)	12.00	4.58	1.650	50	121.00	
W-2470/H3 ⁵		34	Type H3 Halogen (77 watts)	24.00	2.92	1.650	225	146.00	

Pictures are not actual size.















Ask about availability of additional types and sizes not shown.

¹Approximate Candle Power. ²Maximum Overall Length. ³Dual Filament. ⁴Fleet Duty Bulb. ⁵Halogen Bulb ⁶Long Life

⁷Bright Light

MINIATURE BULBS

B5

TYPE T-4	ECONOMY		FIG	BASE TYPE	VOLTS	AMPS	MOL ²	AVERAGE LIFE HRS	APPROX C.P. ¹
	PART#	PART#							
All T-4 bulbs shown here are HALOGEN	W-1A/27W ⁵		35	G7.1	12.80	2.11	2.500	300	50.00
	W-795 ⁵	J-795 ⁵	36	Single Contact Bayonet	12.80	3.91	2.500	200	108.00
	W-11005		37	SV8.5mm (5 watts)	13.00	0.39	1.457	150	4.00
	W-H9005 ⁵	J-H9005 ⁵	38	90°	Hi 12.80	5.08	2.165	150	136.00
	W-H9006 ⁵	J-H9006 ⁵	39	90°	Lo 12.80	4.30	2.165	320	80.00
		J-H9008 ⁵	40	P26.4t	Hi 12.80	4.69	3.740	200	119.00
				Lo 12.80	4.29		1500	80.00	
									
	FIG. 35	FIG. 36		FIG. 37	FIG. 38	FIG. 39	FIG. 40		
TYPE T-4-5/8		J-1210055/H4 ^{5/6}	41	P43t (100/55 watts)	Hi 13.20	8.33	3.610	75	191.00
	W-H9003 ⁵	J-H9003 ⁵	41	P43t (60/55 watts)	Lo 13.20	4.58		150	80.00
					Hi 12.00	5.00	3.610	150	120.00
					Lo 12.00	4.58		320	72.00
	W-1255/H7 ⁵	J-1255/H7 ⁵	42	PX26d (55 watts)	13.20	4.58	2.360	500	119.00
		J-1270/H7 ⁵	42	PX26d (70 watts)	13.20	5.83	2.360	200	139.00
		J-1255/H11 ⁵	43	PGJ19-2 (55 watts)	13.20	4.58	2.630	500	107.00
	W-H9004 ⁵	J-H9004 ⁵	44	Straight (65/45 watts)	Hi 12.80	5.08	2.756	150	95.00
				Straight (65/45 watts)	Lo 12.80	3.58		320	56.00
		J-H9004LL ^{5/6}	45	Axial Prefocus (P29t)	Hi 12.80	5.08	4.020	150	95.00
				Axial Prefocus (P29t)	Lo 12.80	3.51		850	56.00
	W-H9007 ⁵	J-H9007 ⁵	46	Special (65/55 watts)	12.80	5.08	2.756	200	107.00
		J-H9007LL ^{5/6}	47	Axial Prefocus (P29t)	Hi 12.80	5.08	3.740	300	107.00
				Axial Prefocus (P29t)	Lo 12.80	4.29		1200	80.00
	W-2475/H4 ⁵		41	P43t (75 watts)	24.00	3.13	3.610	150	158.00
									
	FIG. 41	FIG. 42		FIG. 43	FIG. 44	FIG. 45	FIG. 46	FIG. 47	
TYPE T-5	W-912	J-912		Wedge	12.80	1.00	1.490	1000	12.00
	W-921	J-921		Wedge	12.80	1.40	1.490	1000	21.00
	W-906			Wedge	13.00	0.69	1.490	1000	6.00
	W-916NA			Wedge	13.50	0.54	1.490	10000	1.50
	W-916			Wedge	13.50	0.54	1.490	10000	2.00
	W-904			Wedge	13.50	0.69	1.490	5000	4.00

Pictures are not actual size.
Ask about availability of additional types and sizes not shown.

Miniature Bulbs are available from the following vendors:

WAGNER[®]
LIGHTING PRODUCTS
The Automotive Lighting Experts™





 **GE Lighting**

CEC INDUSTRIES LTD.

¹Approximate Candle Power. ² Maximum Overall Length. ³ Dual Filament. ⁴ Fleet Duty Bulb. ⁵ Halogen Bulb ⁶ Long Life
⁷ Bright Light

Toll Free: 800-922-6527 • Fax: 248-634-2022 • www.statewire.com



	PART#	PRIMARY APPLICATION	DESIGN VOLTS	INITIAL MAXIMUM CANDLEPOWER	Horz Vert BEAM SPREAD*	AVG LIFE	BASE TYPE
PAR - 36 (4-1/2" Diameter) 	W-4406	Flood, Tractor	12.80	600	80 x 30	300	Screw
	W-4411	Farm, Tractor	12.80	3,000	30 x 25 ^T	300	Screw
	W-4411-1	Tractor	12.80	3,000	30 x 25 ^T	300	Blade
	W-4411-MP ²	Tractor	12.80	3,000	30 x 25 ^T	300	MP
	W-4414A	Signal	12.80	750	50 x 25	300	Screw
	W-4415	Fog, Automotive	12.80	9,000	40 x 5	300	Screw
	W-4415A	Fog, Automotive	12.80	7,000	40 x 5	300	Screw
	W-4416	Spot, Automotive	12.80	35,000	11 x 4.5	100	Screw
	W-4461	CIM*/Tractor	12.80	6,000	30 x 25	320	Screw
	W-4466	Flood, Tractor/CIM*	12.80	900	80 x 30	300	Screw
	W-7400	Flood, Narrow	12.80	33,000	12 x 5	300	MP
	W-7414Y	Signal, Yellow	12.80	1,000	50 x 25	300	Screw
W-4589	Cockpit, Flood, Aircraft	28.00	5,000	Trapezoidal	400	Screw	
PAR - 46 (5-3/4" Diameter) 	W-4000	Headlamp Automotive	Hi 12.80 Lo 12.80	25,000 11,000	34 x 7 34 x 7	320 200	3 Lug
	W-4412	Fog, Automotive	12.80	11,000	40 x 5	300	Screw
	W-4412A	Fog, Automotive	12.80	8,800	40 x 5	100	Screw
	W-4435	Spot, Automotive	12.80	75,000	5 x 5	100	Screw
	W-4436	Signal, Automotive	12.80	60,000	10 x 4	100	Screw
	W-4535	Spot, Automotive	12.80	75,000	5 x 5	100	Screw
	W-4579	Headlamp, CIM*	Hi 28.00 Lo 28.00	24,000 11,000	25 x 7 25 x 7	400 100	3 Lug
	PAR - 56 (7" Diameter) 	W-6014	Headlamp Automotive	Hi 12.80 Lo 12.80	32,000 25,000	34 x 7 34 x 7	200 320
W-4860		Auto Headlamp Military	Hi 28.00 Lo 28.00	24,000 12,000	34 x 7 34 x 7	400 400	WP
PAR Rectangle 		100 X 165 mm					
	W-4651	Headlamp, Auto	Hi 12.80	32,000	40 x 5	200	2 Lug
	W-4652	Headlamp, Automotive	Hi 12.80 Lo 12.80	12,500 22,500	34 x 7 34 x 7	200 320	3 Lug
	W-4921-1	Fog, Automotive	12.80	17,000	40 x 5	200	MP
	142 X 200 mm						
W-6052	Headlamp Automotive	Hi 12.80 Lo 12.80	35,000 30,000	34 x 7 34 x 7	150 320	3 Lug	

¹ Bright Light

² Combination Blade and Screw

^T Trapezoidal

*CIM = Construction, Industrial Machinery

HALOGEN SEALED BEAMS

B7



	PART#	PRIMARY APPLICATION	DESIGN VOLTS	INITIAL MAXIMUM CANDLEPOWER	Horz Beam	Vert Spread°	AVG LIFE	BASE TYPE
PAR - 36 (4-1/2" Diameter)	W-H7614	Flood, Headlamp/CIM*	12.80	2,000	70 x 30		50	Screw
	W-H7616	Spot, Automotive	12.80	70,000	7 x 4		300	Screw
PAR - 46 (5-3/4" Diameter)	W-H5001	Headlamp, Auto	Hi 12.80	50,000	40 x 7		200	2 Lug
	W-H5006	Headlamp, Auto	Hi 12.80	15,000	40 x 7		200	3 Lug
			Lo 12.80	25,000	40 x 7		450	
PAR - 56 (7" Diameter)	W-H6024	Headlamp, Auto	Hi 12.80	35,000	35 x 7		200	3 Lug
			Lo 12.80	27,000	35 x 7		450	
PAR Rectangle 	<i>92 X 150 mm</i>							
	W-H9406	Flood, Tractor	12.80	1,350	70 x 30		400	2 Lug
	W-H9420	Driving, Auto	12.80	47,000	15 x 5		200	2 Lug
	<i>100 X 165 mm</i>							
	W-H4651	Headlamp, Auto	Hi 12.80	50,000	40 x 5		200	2 Lug
	W-H4656	Headlamp, Auto	Hi 12.80	15,000	35 x 7		200	3 Lug
			Lo 12.80	25,000	35 x 7		450	
	<i>142 X 200 mm</i>							
	W-H6054	Headlamp, Auto	Hi 12.80	40,000	35 x 7		200	3 Lug
			Lo 12.80	35,000	35 x 7		450	
W-H6054BL ¹	Headlamp, Auto	Hi 12.80	28,000	80 x 7		150	3 Lug	
		Lo 12.80	27,000	80 x 7		450		

TWO LIGHT ROUND



W-6014
W-H6024

TWO LIGHT RECTANGLE



W-6052
W-H6054
W-H6054BL

AUTOMOTIVE HEADLAMP SYSTEM

FOUR LIGHT ROUND

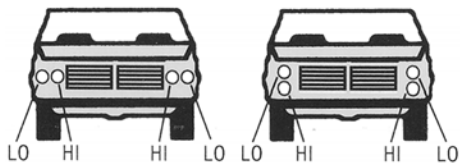

W-4000
W-H5001
W-H5006

LOW - HIGH
HIGH
LOW - HIGH

FOUR LIGHT RECTANGLE

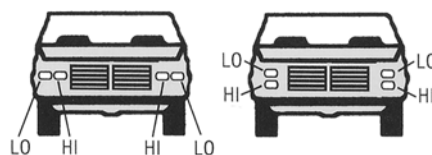

W-4651
W-4652
W-H4651
W-H4656

HIGH
LOW - HIGH
HIGH
LOW - HIGH

¹Bright Light

²Combination Blade and Screw

[†]Trapezoidal

*CIM = Construction, Industrial Machinery

Toll Free: 800-922-6527 • Fax: 248-634-2022 • www.statewire.com

ATM and ATC fuses feature an enclosed element - offering protection against shocks and sparks, plus corrosion resistance for longer service life.

ATM / MINI BLADE FUSES



BULK - 25 / bag.
BOXED - 5 / box.

ATM / MINI LOW PROFILE BLADE FUSES

PART#	AMPS	COLOR
ATMLP-B7-1/2	7-1/2	Brown
ATMLP-B10	10	Red
ATMLP-B15	15	Light Blue
ATMLP-B20	20	Yellow
ATMLP-B25	25	Clear
ATMLP-B30	30	Green

Color coded to all blade fuses. Being used on most imported cars.
Std Pkg - 5 / box

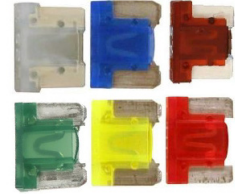

BULK PART#	AMPS	COLOR	BOXED PART#
ATM-2	2	Gray	ATM-B4
ATM-3	3	Violet	
ATM-4	4	Pink	
ATM-5	5	Tan	
ATM-7-1/2	7-1/2	Brown	
ATM-10	10	Red	
ATM-15	15	Light Blue	
ATM-20	20	Yellow	
ATM-25	25	Clear	
ATM-30	30	Green	

ATM / MINI LED BLADE SYTLE FUSES

PART#	AMPS	COLOR
ATM-LED10	10	Red
ATM-LED15	15	Light Blue
ATM-LED20	20	Yellow
ATM-LED25	25	Clear
ATM-LED30	30	Green



Smart Glow Automotive Blade Fuses set the standard for automotive circuit protection. They feature industry standard color coding to indicate amperage rating. Smart Glow fuses (ATO and Mini) are innovative automotive style fuses that feature an **indicator light that glows** when the fuse is blown, saving time to troubleshoot an open circuit. Snaps into place, no tools required. **Standard Package: 5.**

STANDARD ATC FUSES

BULK - 50 per bag.
BOXED - 5 per box.

Direct interchange for ATO applications.



STANDARD LED BLADE SYTLE FUSES

PART#	AMPS	COLOR
ATO-LED3	3	Violet
ATO-LED7-1/2	7-1/2	Brown
ATO-LED10	10	Red
ATO-LED15	15	Light Blue
ATO-LED20	20	Yellow
ATO-LED25	25	Clear
ATO-LED30	30	Green



Smart Glow Automotive Blade Fuses set the standard for automotive circuit protection. They feature industry standard color coding to indicate amperage rating. Smart Glow fuses (ATO and Mini) are innovative automotive style fuses that feature an **indicator light that glows** when the fuse is blown, saving time to troubleshoot an open circuit. Snaps into place, no tools required. **Standard Package: 5.**

BULK PART#	AMPS	COLOR	BOXED PART#
ATC-1	1	Black	ATC-B1
	2	Gray	ATC-B2
ATC-3	3	Violet	ATC-B3
ATC-5	5	Tan	ATC-B5
ATC-7-1/2	7-1/2	Brown	ATC-B7-1/2
ATC-10	10	Red	ATC-B10
ATC-15	15	Light Blue	ATC-B15
ATC-20	20	Yellow	ATC-B20
ATC-25	25	Clear	ATC-B25
ATC-30	30	Green	ATC-B30
ATC-40	40	Amber	ATC-B40

FUSE TAP

Hot-line tap-in for Blade-Style fuses.
Standard Package: 100



ATC-TAP
.250 WIDTH



ATM-TAP
.187 WIDTH

MAXI FUSES

Sold Individually



PART#	AMPS	COLOR
MAX-20	20	Yellow
MAX-30	30	Green
MAX-40	40	Amber
MAX-50	50	Red
MAX-60	60	Blue
MAX-70	70	Brown
MAX-80	80	Clear

A-N-N FORKLIFT FUSES

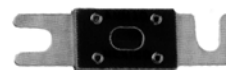

125 VOLTS

PART#	AMPS
ANN-200	200



Standard Package: 5

*Pictures are not actual size.
Ask about availability of additional sizes and styles not shown.*



State Wire and Terminal, Inc.

BLADE FUSE HOLDERS



B9



ATC FUSE HOLDER		
FH-ATC  16 GA Black Rated up to 20 Amps	FH-ATC30  12 GA Orange Rated up to 30 Amps	FH-ATC35  10 GA Red Rated up to 35 Amps

Fits Standard size ATO/ATC fuse. 4-1/2 inches wire on each end.
 Cover included. **Standard Package: 10**

ATM FUSE HOLDER	
FH-ATM  16 GA Black Rated up to 20 Amps	FH-ATM30  12 GA Orange Rated up to 30 Amps

For miniature blade-style fuse. Cover included. Fuses sold separately. **Standard Package: 10**

MAXI-FUSE HOLDER	
FH-MAX-B  Body 6 GA Rated up to 60 Amps	FH-MAX-C  Cover
For large blade-style fuse. Standard Package: 1 FH-MAX (Body + Cover)	

WATER RESISTANT	
FH-WP16ATM  Mini 16 GA Black Wire Rated up to 20 Amps	FH-WP12ATC  ATC / ATO 12 GA Orange Wire Rated up to 30 Amps

Electrical system protection for fleets, construction equipment, aircraft service vehicles, outdoor power equipment and marine installations. Resistant to moisture, salt spray and engine compartment fluids. Withstands 50 g physical shock. Operating temperature range from -40 to 125°C. Nylon body with latching cap. Silicone rubber seals at wires and cap. Has mounting tab. **Sold Individually.**

3M SELF-STRIPPING FUSE HOLDER for Blade Style Fuses or Circuit Breakers

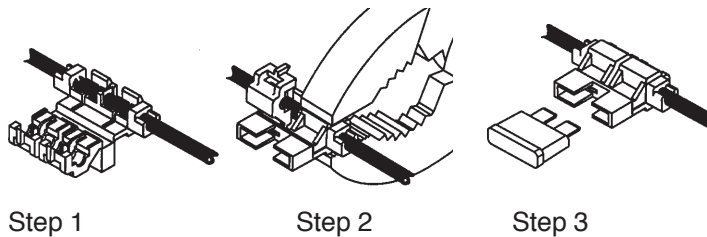

PART# FH-3M
 Auto fuse holder. AWG range 18-14 (.75-1.5mm). Use to install a blade-type automotive fuse or circuit breaker between power source and device. Simplified hookup saves money by eliminating need for butt connectors or quick-connect terminals. Installs with a common pliers so no special tools are needed. Rated up to 20 Amp Fuse.
Standard Package: 10

BLADE-STYLE CIRCUIT CONVERTERS

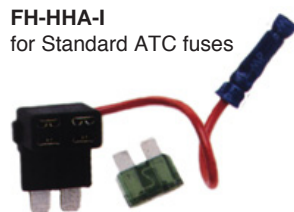

FH-HHA-I
 for Standard ATC fuses



FH-HHH-I
 for Mini ATM fuses

Converts a blade-style fuse circuit into two fusible circuits. It plugs into the fuse block and accepts two fuses to provide protection for the existing circuit and the add-on circuit (**10amp maximum**). Fuses sold separately. **Sold Individually.**

Toll Free: 800-922-6527 • Fax: 248-634-2022 • www.statewire.com

B10 GLASS FUSES AND HOLDERS

AGC FUSES



Electrical Characteristics
Rating **Blow Time**
 110% 4 hours, Minimum
 135% 1 hour, Maximum
 200% 10 seconds, Maximum
Fuse Dimensions:
 Diameter, 1/4 inch,
 Length, 1-1/4 inches

250V

32V

AMPS	BAGGED PART #	BOXED PART#
1	AGC-1	
1-1/2		AGC-B1-1/2
2-1/2	AGC-2-1/2	
3	AGC-3	AGC-B3
4		AGC-B4
5	AGC-5	AGC-B5
7-1/2	AGC-7-1/2	AGC-B7-1/2
10	AGC-10	AGC-B10
15	AGC-15	AGC-B15
20	AGC-20	AGC-B20
25	AGC-25	AGC-B25
30	AGC-30	AGC-B30
40	AGC-40	AGC-B40
	100/bag	5/box

SFE FUSES



5/8

Electrical Characteristics
Rating **Blow Time**
 110% 4 hours, Minimum
 135% 1 hour, Maximum



3/4



7/8

Fuse Dimensions:
 1/4 x Length Tabulated

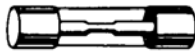

1-1/16

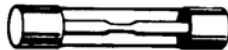

1-1/4

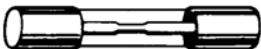

1-7/16

32V

PART#	BOXED PART#	AMPS	LENGTH INCHES
SFE-7-1/2		7-1/2	7/8
	SFE-B9	9	7/8
	SFE-B14	14	1-1/16
	SFE-B20	20	1-1/4
	SFE-B30	30	1-7/16
	100/bag		5/box

Pictures are not actual size.
 Ask about availability of AGA, AGU, AGW, MDL & GBC Fuses and additional sizes not shown.



For 1-1/4 INCH GLASS FUSES

Nylon Fuse Holder comes complete with 5-1/2 inch of wire each side. Includes 30 amp Fuse. **Sold in bundles of 10.**

PART#	GAUGE	AMPS	COLOR
FH-12	12	30	Orange



Fuse Holder comes complete with 5 inch loop of wire. Bakelite Housing. Includes 20 amp Fuse. **Sold in bundles of 10.**

PART#	GAUGE	AMPS	COLOR
FH-14	14	20	Black

PANEL-MOUNT FUSE HOLDER



PART# FH-PANEL - Vibration Resistant. 15 Amps. 250 Volts. URC Ratings. 1/4" Quick Connect Terminals. For 1/4 x 1-1/4 Glass Fuses. Fuses sold separately. U.L. Recognized and CSA Listed. **Standard Package: 10**

UNIVERSAL TYPE for GLASS FUSES - STANDARD



- Rated up to 30 amps, 32 volts
- Accepts 12-18ga wire
- Fits 1/4" by 7/8", 1", 1-1/4" fuses
- Nylon body.
- Fuses sold separately.

PART#	STD PKG	COLOR
FH-U	10	Yellow

INSTALLATION

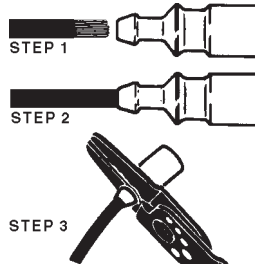

- 1 Strip insulation from wire (approximately 3/8 inch).
- 2 Insert wire holder
- 3 Crimp terminal through body.
- 4 Repeat steps 1-3 for other half of holder.
- 5 Insert fuse.
- 6 Snap housing together.

ATC BLADE-TYPE FUSE PANELS

Part# FB-ATC6
Standard Style

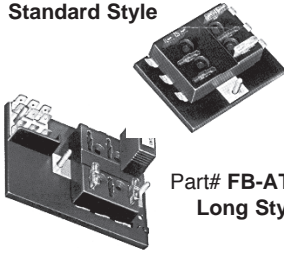

Part# FB-ATC6L
Long Style

NO. OF BRANCHES	STANDARD PART#	LONG PART#
4	FB-ATC4	FB-ATC4L
6	FB-ATC6	FB-ATC6L
8	FB-ATC8	
10	FB-ATC10	
12	FB-ATC12	

Compact, lightweight, yet rugged panel for use in recreational, trucks, buses and boats. Accepts ATC® blade-type fuses or USD blade-type automatic or manual reset circuit breakers. 30amp maximum rating per branch circuit. 160amp maximum rating for all branches. Easy wiring with **Standard Style** (1/4" quick-connect branch circuit terminals) or **Long Style** (common ground or 1/4" quick connect). No top cover needed; recessed, male fuse contacts. Molded of high grade thermoplastic. Rated to 105°C. Recessed mounting holes. **Sold individually.**

4 GANG ATC FUSEBLOCK

Stackable. Housing can snap-lock together making it easy to add as many additional circuits as you need. **Standard Package 5.**

PART# GM-12004572
4 GANG TERMINAL FOR GM-12004943

PART# GM-12004943
4 GANG FUSE BLOCK

PART# GM-12004996
FUSE TERMINAL

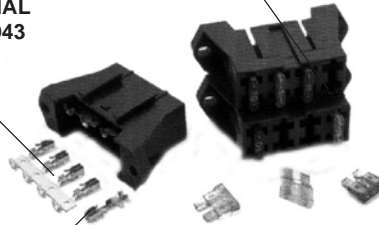

NON-FEED JUNCTION BLOCK

PART# FB-1 Non-Feed through stud-type junction block. 3/8-16 threads, 7/8" long. Glass filled nylon construction. Nuts and washers sold separately. Maximum temperature 220°F (105°C) and maximum current of 250 amps. **Sold individually.**



FUSE LINK Wiring Harness Protection

From the Battery to the Fuse Box, Starter and Alternator, etc. When a catastrophic problem occurs, such as a short caused by worn insulation, the FUSE LINK opens before the wiring harness melts. **Sold individually**



FLS is a fusible link with FEMALE connectors. 10kA Interrupting Rating. Terminal Width .250 or 6.3mm. 32V.

PART#	AMPS	COLOR
FLS-30	30	Pink
FLS-40	40	Green



FMX is a fusible link with FEMALE connectors. 1kA Interrupting Rating. Terminal Width .250 or 6.3mm. 32V.

PART#	AMPS	COLOR
FMX-20	20	Lt. Blue
FMX-30	30	Pink
FMX-40	40	Green
FMX-50	50	Red
FMX-60	60	Yellow



FMXLP Female fuse offers high amp protection. **Low profile** J-case interchange with Littelfuse. 1kA Interrupting Rating. Terminal Width .250 or 6.3mm. 58V.

PART#	AMPS	COLOR
FMXLP-20	20	Blue
FMXLP-25	20	White
FMXLP-30	30	Pink
FMXLP-40	40	Green
FMXLP-50	50	Red
FMXLP-60	60	Yellow



FLF is a fusible link with FEMALE connectors. 10kA Interrupting Rating. Terminal Width .315 or 8mm. 32V.

PART#	AMPS	COLOR
FLF-20	20	Lt. Blue
FLF-30	30	Pink
FLF-40	40	Green
FLF-50	50	Red
FLF-60	60	Yellow

FUSIBLE LINK WIRE

A fusible link is a special section of low tension cable installed by an original equipment manufacturer and designed to open a circuit when subjected to extreme current overload. Its purpose is to minimize wiring system damage when such an overload accidentally occurs in those circuits protected by the fusible link. A short circuit causes the fusible link to act as an element in a "slow-blow" fuse. A fusible link is not intended to be used in place of a fuse but only where a fuse cannot be economically employed. The vehicle manufacturer should be consulted about questions on fusible link length and size. **Extreme caution should be taken to always replace a fusible link with the same gauge and length as installed by the manufacturer.**

CUT LENGTHS

PART#	GAUGE	LENGTH	PKG	COLOR
FUL-14	14	10-1/2"	5	Green

Stud size 5/16"



25 FOOT SPOOL

PART#	GAUGE	COLOR
FUL-S14	14	Gray



B12

CIRCUIT BREAKERS

TYPE I – Cycling – Automatic Reset. Type 1 will cycle continuously during an over current condition. The composite alloy material will bend and separate the contacts when an over current situation occurs and return to the run mode as it cools. This process will continue until the source of the over current is removed or corrected.

BLADE TERMINALS

12VDC. 3-length break off leg. Color coded. **Sold Individually.**

PART#	AMPS	COLOR
CB-ATC10	10	Red
CB-ATC15	15	Blue
CB-ATC20	20	Yellow
CB-ATC30	30	Green

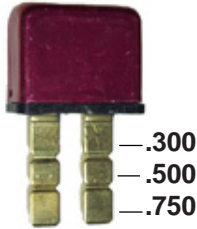

ATC STYLE

Designed to fit ATC style fuse panels. These ATC breakers are the thinnest available in the aftermarket. **Sold Individually.**



PART#	AMPS	COLOR
CB-221-10	10	Red
CB-221-15	15	Blue
CB-221-20	20	Yellow
CB-221-25	25	White
CB-221-30	30	Green

MINI

Mini breakers match the blade footprint of ATM fuses. Ultrathin to fit in tight spaces. They are the smallest automotive circuit breakers on the market. **Sold Individually.**



PART#	AMPS	COLOR
CB-ATM10	10	Red
CB-ATM20	20	Yellow
CB-ATM30	30	Green

MAXI

Sold Individually.

PART#	AMPS
CB-MAX30	30
CB-MAX50	50



UNIVERSALS

12 volt circuit breakers. Hardware included. **Sold individually.** Some sizes available in plastic.



DOUBLE BREAKER ASSEMBLY

PART# CH-03088-60
6-12VDC. 60Amps. Two 30A breakers in parallel for higher amperage cycling. 2" Bracket has two mounting holes 1.56" on centers. **Sold Individually.**



AMPS	PART#	PART #	PART #
10			P-54-510PL ¹
15	P-54-115	P-54-215	
20	P-54-120	P-54-220	P-54-520
25		P-54-225	
30	P-54-130	P-54-230	P-54-530
40	P-54-140	P-54-240	P-54-540
50	P-54-150	P-54-250	

¹ Plastic

TYPE II – Non-Cycling – Modified Reset. Unlike the auto reset design, Type II has an additional resistive component built into it which raises the ambient component temperature within the circuit protector. This limits the number of cycles (less than 10) by not allowing the composite alloy to cool and reset the circuit. The circuit will remain open with less than 1.0 amp current flow as long as the voltage is applied.

NON-CYCLING BLADE TERMINALS

PART#: P-54-725
25 Amps. 12 VDC. 3-length break-off legs. Other Amps available. **Sold Individually.**

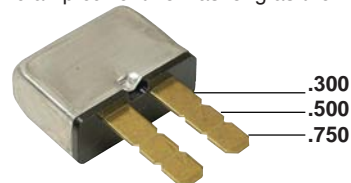

TYPE III – Push Button – Manual Reset. Type III circuit breakers introduce a non current carrying object between the contacts when they open. To reset the contacts, an external button or lever must be activated to return to normal operation.

ATC CIRCUIT

PART#	AMPS	COLOR
CB-223-20	20	Yellow
CB-223-30	30	Green

12 Volt, thermal type circuit breaker. **Sold Individually.**



SINGLE POLE THERMAL BREAKERS

Used for battery chargers, trucks, buses, RV's, trolling motors, etc. Rating from 5A to 50A; 12VDC. Complies with SAE Standard J553. **Sold Individually.**

PLASTIC WITH 90° BRACKET

PART#	AMPS
P-54-631PL	30
P-54-641PL	40
P-54-651PL	50



HIGH-AMP WATERPROOF SURFACE-MOUNT

Switchable. For auxiliary and accessory circuits for trucks, buses, RV's, marine, battery charger systems and DC audio systems. Sealed for use in engine compartments or bilge areas. **Sold Individually.**

PART#	AMPS
CB-185-50	50
P-54-870PL	60
CB-185-80	80
CB-185-100	100
CB-185-135	135
CB-185-150	150



PANEL-MOUNTED





32VDC .250" quick-connect terminals. Used in trucks, RVs, boats, buses, etc. **Sold Individually.**



PART#	AMPS
CB-174-10	10
CB-174-15	15
CB-174-20	20
CB-174-30	30

State Wire and Terminal, Inc.

HEAVY DUTY ELECTRONIC FLASHERS

<p>FL-TRI-12</p>  <p>2 Prongs 2-4 Signal Lamps 1-10 Hazard Lamps 12 Volts</p>	<p>FL-TRI-12I</p>  <p>2 Prongs 1-12 Signal Lamps 1-12 Hazard Lamps 11-15 Volts</p>	<p>FL-TRI-13</p>  <p>3 Prongs 2-4 Signal Lamps 1-10 Hazard Lamps 12 Volts</p>	<p>FL-TRI-23</p>  <p>3 Prongs 2-4 Signal Lamps 1-10 Hazard Lamps 24 Volts</p>	<p>FL-TRI-13A2</p>  <p>3 Prongs 6 per side Signal Lamps 12 Volts</p>
<p>Lasts up to 10 times longer than thermal flashers. These enhanced-performance flashers are manufactured with electronic precision and reliability for applications that require higher-than-normal load lamps. Their patented design is robust enough for long-haul and industrial uses. Clear, audible click, louder than original thermal flasher.</p>				<p>For "wig-wag" alternating headlight applications on police/emergency vehicles</p>

LED ELECTRONIC FLASHERS

 <p>FL-LED-EF30AL Self-Adjusting 3 Terminal alternating flasher. Sold Individually.</p>	 <p>FL-LED-EF32L Self-Adjusting 2 Terminal variable load flasher. Sold Individually.</p>	<p>60-120 flashes per minute. Heavy duty design, external wire provides ground. Automatically adjusts to LED current draw. Steady flash rate for all LED & incandescent applications. 11-15 volt, 0.10-25 amp capacity. FMVSS 108, SAE J945, SAE J590, and 1690 Class A.</p>
--	---	---

THERMAL FLASHERS

 <p>FL-550 12 Volt, 3 Prong. Up to 12.8 Amps. Will handle 2 to 6 bulbs. For directional and hazard signal lights. DOT approved. Variable load. Standard Package: 5</p>	 <p>FL-552 12 Volt, 2 Prong. Up to 12.8 Amps. Will handle 2 to 6 bulbs. For directional and hazard signal lights. DOT approved. Variable load. Standard Package: 10</p>	 <p>FL-575 12 Volt, 2 Prong. Up to 12.8 Amps. Will handle 1 to 8 bulbs. For directional and hazard signal lights. DOT approved. Variable load. Standard Package: 5</p>
---	--	---

Thermal Flashers use heat build-up to flash circuit on and off. Features an audible click, alerting driver that a directional signal is engaged. Generally used in older model year vehicles. Operates correctly under variable load – flashing the designated vehicle lamps only; or additional lamps when a trailer is in tow. Does not indicate lamp outage.

ELECTRONIC FLASHER

 <p>PM-576 20-lamp, 12-volt flasher. Medium-duty 2-prong. 45-amp max rating. 75-115 flash rate. Electronic chip improves switching operations and extends life. 1-7/8" tall. Meets FMVSS 108 and SAE J590 & J945 specifications. Sold Individually.</p>
--

HEAVY DUTY FLASHER PIGTAIL

 <p>CH-03029 Three 14GA wires, 8" long terminating in plated bronze contacts. Sold Individually.</p>
--

For your convenience we do accept ...



Pictures are not actual size. Ask about availability of additional flashers not shown.

Toll Free: 800-922-6527 • Fax: 248-634-2022 • www.statewire.com

B14

RELAYS



Figure 1



Figure 2



Figure 3



Figure 4



Figure 5



Figure 6

MINI					MUST OPERATE VOLTAGE	MUST RELEASE VOLTAGE	(OHMS) RESISTANCE	PIN	CIRCUIT	TYCO (P & B) OR BOSCH PART#
PART#	FIGURE	VOLTS	AMPS	TYPE						
HR-30	1	12	20/40	SPDT	8.5V	1.0V	86	B1	S3	0332209151
HR-30B	5	12	20/40	SPDT	8.5V	1.0V	86	B1	S3	0332209150
HR-87402	1	12	40	SPST	8.5V	1.0V	86	B3	S2	VF4-11F11
HR-70B	6	12	70	SPST	8.5V	2.5V	85	B3	S2	VF7-11F11-S01

MINI WITH RESISTOR					MUST OPERATE VOLTAGE	MUST RELEASE VOLTAGE	(OHMS) RESISTANCE	PIN	CIRCUIT	TYCO (P & B) OR BOSCH PART#
PART#	FIGURE	VOLTS	AMPS	TYPE						
HR-49401	2	12	20/30	SPDT	8.5V	1.0V	75	B1	S4	
HR-87423	1	12	20/40	SPDT	8.5V	1.0V	75	B1	S4	0332209159
HR-87426	5	24	10/20	SPDT	15.0V	2.0V	282	B1	S4	VF4-45H11-S01
HR-87115	2	24	10/20	SPDT	15.0V	2.0V	282	B1	S4	VF4-15H11-S08
HR-75102	5	12	40	SPDT	8.0V	1.2V	85	B1	S4	0332019151

MICRO					MUST OPERATE VOLTAGE	MUST RELEASE VOLTAGE	(OHMS) RESISTANCE	PIN	CIRCUIT	TYCO (P & B) OR BOSCH PART#
PART#	FIGURE	VOLTS	AMPS	TYPE						
HR-87416	3	12	10/20	SPDT	9.0V	1.0V	81	D	S4	0332207307
HR-87414	4	12	20	SPST	8.0V	1.0V	92	E	S5	VFM-11F41-S01

PIN CONFIGURATIONS

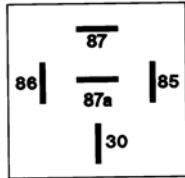

B1

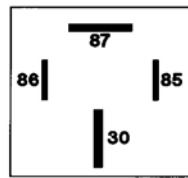

B3

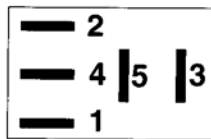

D

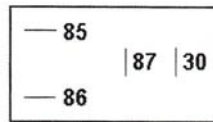

E

CIRCUIT DIAGRAMS

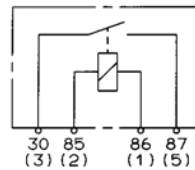

S2

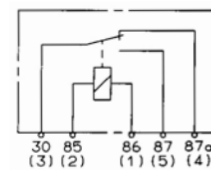

S3

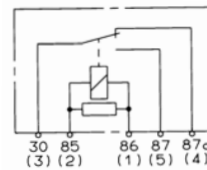

S4

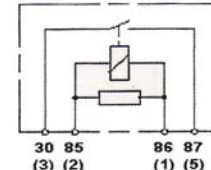

S5

ACCESSORIES

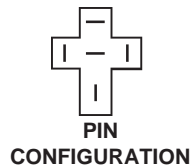

PART#	DESCRIPTION	STD PKG
HR-BASE5	Base for relay with 5 terminals	5
HR-SOCKET5	Base for relay without terminals	5
HR-87272	Terminals - 16-14GA	100

75A POWER RELAY

PART# HR-75551
 12V SPST 75A.
 Four Terminals, Dual Contact
 TYCO# V23232-D0001-X001
 BOSCH# 0332002150
 Sold Individually



Pictures are not actual size. Ask about availability of other Relays not shown on this Page.

State Wire and Terminal, Inc.

 <p>PART# APT-1 SINGLE CONTACT BASE Pigtails with solid brass contact assembled with rubber boot. Used with Lamp Nos. 63, 67, 81, 87, 89, 93, 209, 1003, 1073, 1129, 1133 and 1141. Standard Package - 10</p>	 <p>PART# APT-2 DOUBLE CONTACT BASE Pigtails with solid brass contact assembled with rubber boot. Used with Lamp Nos. 64, 68, 82, 88, 90, 94, 210, 1004, 1034, 1074, 1130, 1154, 1157, 1158 and 1176. Standard Package - 10</p>	 <p>PART# PM-413-07 PIGTAIL Two wires with brass contacts, nylon washer, and plug with stainless steel spring. Indexing type for all S-8 double contact bulbs. Sold Individually.</p>
 <p>PART# APT-H9004/7 GM-Ford-Chrysler. Three - 18 GA Leads Bulbs H-9004 & H-9007 Standard Package - 1</p>	 <p>PART# APT-H9005/H10 High Beam. GM-12101898. Two - 18 GA Leads. Bulb H-9005 & H10 Series. Standard Package - 1</p>	 <p>PART# APT-H9006 Low Beam. GM-12101897. Two - 18 GA Leads. Bulb H-9006 Standard Package - 1</p>
 <p>PART# CH-02203 SINGLE BAYONET BASE LAMP SOCKET Screw terminals. 11/16"-32 mounting stem. Nut and lockwasher mounting socket. Lamp No. BA15s base bulb Standard Package - 1</p>	 <p>PART# AVC-11154 DOUBLE CONTACT SOCKET ASSEMBLY Tail & Stop Lights for GM. Twist lock type. Focal length 1/8" (8903202, 8914822) Lamp No. 1157. Replaces Gray OEM-Socket. Standard Package - 5</p>	 <p>PART# APT-3 THREE WIRE CONNECTOR For Sealed Beams & Flashers. Used on all cars with three prong Sealed Beam Headlamp Nos. 4002, 5040, 5400, and 6006. Furnished complete with three 12" leads. Also fits 2 and 3 prong flashers. Standard Package - 5</p>
 <p>PART# GS-3480 SIDE MARKER ASSEMBLY For Ford & GM. (GM 6298935, 6294015, 8918527, 8901283; Ford D7ZA-13412-A, D7FZ-13412-A, D0DZ-15A434-B, D40Z-13410-E). Replaces side marker light socket assembly on most Ford and GM cars. Lamp Nos. 158, 194 and 194A. Standard Package - 5</p>	 <p>PART# GS-2128 (RED) PART# GS-2128A (AMBER) INDICATOR LAMP 2 male .250 tabs for easy installation. Mounts into 1/2" hole. 12 volt applications. Standard Package - 5</p>	 <p>PART# HR-PGTL5-24 RELAY PIGTAIL 24" Wires with inter-lockable Housing. (3) 14 Gauge Wires: Yellow-Red-Blue (2) 18 Gauge Wires: White-Black Standard Package - 1</p>
	 <p>PART# HP-12 90° HEATER PLUG Universal Socket Sensor. Fits 6-32 (.136) stud. For GM 12112171 & Delco PT404. Attaches to Sending Unit. Standard Package - 5</p>	

PLASTIC ELECTRICAL TAPE

PT-1700	PT-16720	PT-33	PT-88
 <p>3/4 Width. 60ft Length. 7 Mil. Used for protective jacketing and harnessing. Abrasive and UV resistant. UL Listed and CSA Certified. 80°C / 176°F</p>	 <p>3/4 Width. 66ft Length. 7 Mil. Flexible, stretchy, conformable, commercial grade vinyl that is flame retardant. Used for protective jacketing and harnessing. UL Listed. 80°C / 176°F</p>	 <p>3/4 Width. 66ft Length. 7 Mil. All weather. For use at not more than 220°F. Gives full electrical and mechanical protection. UL Listed and CSA Certified. 105°C / 220°F</p>	 <p>3/4 Width. 66ft Length. 8.5 Mil. All weather. Heavy duty. Extra flexible for small wires. UL Listed and CSA Certified. 105°C / 220°F</p>
10 in a sleeve. 100 in a case.			

SHRINK TAPE

Scotch™ 130C Linerless Rubber Splicing Tape



PART# ST-T3/4 - 3/4" Width. 30ft Length. 30 Mil.
Linerless, self-bonding primary insulating tape, designed to insulate splices and terminate cables whose overload temperatures can reach 130°C. Physical and electrical properties unaffected by degree of stretch or solvents normally used when splicing high-voltage cables. Uniform tape unwinds from roll. 5 year shelf life. UL Listed. **Sold Individually.**

3M COLORED VINYL ELECTRICAL TAPE



PART#	COLOR	WIDTH	LENGTH
PT-35BLU	Blue	3/4	66ft
PT-35BRN	Brown	3/4	66ft
PT-35GRN	Green	3/4	66ft
PT-35ORG	Orange	3/4	66ft
PT-35RED	Red	3/4	66ft
PT-35WHT	White	3/4	66ft
PT-35YEL	Yellow	3/4	66ft

7 Mil premium grade vinyl electrical tape. Stretches and conforms to virtually any shape. Abrasion and weather resistant. Holds tight over a wide range of temperatures. **10 rolls per sleeve. Sold Individually.**

DUCT TAPE

DTC-180 Silver



DTC-180BLK Black



2" Width. 11 Mil Thickness. 28 lbs/inch Tensile Strength. 8% Elongation. 60oz Adhesion to stainless steel - ounces per inch width. General purpose poly-coated cloth tape with high tack. White natural rubber adhesive gives high bond strength. Excellent where dirt and moisture seals are important. 60 yards per roll. **6 rolls per sleeve. 24 per case. Sold Individually**

SCOTCH® AUTOMOTIVE TRANSPARENT DUCT TAPE



PART# 3M-03451 - Transparent when applied, making repairs less obvious. Lasts six times longer than other heavy-duty duct tapes. Tears easily by hand lengthwise and crosswise. Water and UV resistant. Adhesive sides are easily separated if they come into contact with each other. Extremely versatile: can be used on plastic, wood, glass, metal, vinyl and rubber. **Sold Individually.**

ALUMINUM FOIL TAPE

PART# DTC-AF973 - Aluminum foil tape is used to seal and join aluminum backed duct wrap, to create water and vapor barriers, and for temporary metal repair. Used to repair truck beds. **2" x 150ft. 4.4 mils thickness. 16lbs. per inch width tensile strength. 2.0% elongation. 24 Rolls per Case. Sold Individually.**



3M™ SCOTCH® ELECTRICAL MOISTURE SEALANT



PART# 3M-06147 - 2-1/2" Width. 10' Length. Quick and easy method of moisture proofing electrical connections. Protects against vibration, road grime and abrasion. Self-fusing, rubber-based thin insulating mastic compounds laminated to a flexible, all-weather PVC backing. Designed for moisture sealing of electrical connections up to 600 volts. UL Listed. **1 Roll per box.**

ECONOMY GRADE MASKING TAPE



PART#	WIDTH	ROLLS PER	
		SLEEVE	CASE
MT-34	3/4	12	48
MT-2	2	6	24

Resists water, solvents and oil. Good tensile strength. Good for utility packaging purposes. Not recommended for spray painting or oven baking. 60 yards long. **Sold Individually.**

PIPE THREAD SEALANT TAPE



PART# TFT-520 - 1/2" Width. 520" Length. Pipe thread sealant tape rolls on dry and molds into pipe threads forming a leak proof seal. Works on any automotive line. Eliminates messiness of conventional materials. Unaffected by oils, transmission fluids or freon. Never dries out. Permanently lubricated joints never stick. **Sold Individually.**

CONSPICUITY TAPE



Exceeds DOT requirements. Durable, impact resistant. Solvent resistant. Easy Installation. Reflects light even in daytime. Bright Prismatic appearance. **7 Year warranty. Sold Individually.**

PART#	PATTERN	SIZE
3M-67533	11" Red / 7" White	2" x 150 ft
3M-67636 ¹	11" Red / 7" White	2" x 150 ft
PM-465-1	11" Red / 7" White	2" x 150 ft
OP-RT150711B	11" Red / 7" White	2" x 150 ft
3M-67535	6" Red / 6" White	2" x 150 ft
3M-67885	School Bus Yellow	2" x 150 ft

¹ Kiss Cut



Pressure sensitive nylon tape fastener consisting of two mating strips. When pressed together the hooks and loops engage, creating an adjustable and secure closure. To open, simply peel apart. Velcro® tapes can be opened and closed many thousands of times. Available in 75' Rolls.

HOOK and LOOP

PART#	WIDTH	LENGTH	SIDE
VELCRO-1BLK	1 inch	10 feet	Both
VELCRO-BLK1H	1 inch	10 feet	Hook
VELCRO-BLK1L	1 inch	10 feet	Loop
VELCRO-2BLK	2 inches	10 feet	Both
VELCRO-BLK2H	2 inches	10 feet	Hook
VELCRO-BLK2L	2 inches	10 feet	Loop

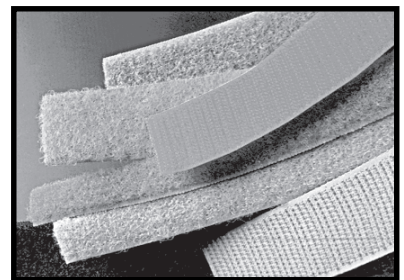

3M™ SCOTCHMATE™ HOOK & LOOP FASTENING SYSTEM

PART# 3M-06480
Convenient way of joining two surfaces together. Premium performance adhesive system. Comprised of 2 non-woven strips, 1 of hook material and 1 of loop material. Each strip is 1" x 12". 12 strips per box.



3M™ SCOTCH® AUTOMOTIVE REFINISH MASKING TAPE 233+ (GREEN)



Designed expressly for the professional auto refinish painter. Conformable, hugs curves and contours. Goes on quickly and easily. Sticks at a touch and stays put. Every feature perfectly balanced to give outstanding masking results. 60 yards length. **Sold individually.**

PART#	SIZE	ROLLS	
		PER SLEEVE	PER CASE
3M-26332	12mm x 55m (1/2")	12	48
3M-26334	18mm x 55m (3/4")	12	48
3M-26336	24mm x 55m (1")	6	24
3M-26340	48mm x 55m (2")	3	12

PVC BOX SEALING TAPE

PART# PT-PKGC - 55 yards length. **Clear.** Strong, excellent for box sealing, fiber drum sealing and other heavy duty needs. 2 inches wide. **6 rolls per sleeve. 36 rolls in a case. Sold individually.**



3M DUAL LOCK™

PART# 3M-06483 - 1 inch width. 4.9 yards length. Continuous plastic strips with mushroom shaped stems, providing reclosable fastening. Pressure sensitive adhesive back for bonding to bare or painted metal, plastics, wood, glass and more. Black.

400 STEMS PER SQUARE INCH



QUICK INDEX SECTION C

C1

Wire / Cable / Tubing / Loom / Power Cord / Hoses / Clamps

- | | |
|--|--|
| C2 Primary Wire (General Purpose Thermoplastic) | C7 Split Loom, Expandable Flex Tubing, Power Cord |
| C3 Trailer Cable, Coiled Cable Assembly and Multi-Conductor Jacketed Boat Cable | C8 Heat Shrink Tubing, Fuel Line and Vapor Emission Hose, Windshield Washer and Vacuum Hose |
| C4 Jacketed Wire and Welding Cable | C9 Hose Clamps, Insulated Metal Clamps and Sleeved Clamps |
| C5 Battery Cables, Straps, Assemblies and Battery Terminal Covers | C10 Nylon Cable Clamps, Parallel Wire Clamps, Glue-On Clamps, Rubber Tie Downs |
| C6 Ripcord (Parallel) Wire, Coaxial Cables, Commercial Coax Connectors and Speaker Wire | Spooled Mechanics Wire and Metal Frame Clips |



ITEMS NOT SHOWN BUT AVAILABLE ON SPECIAL ORDER

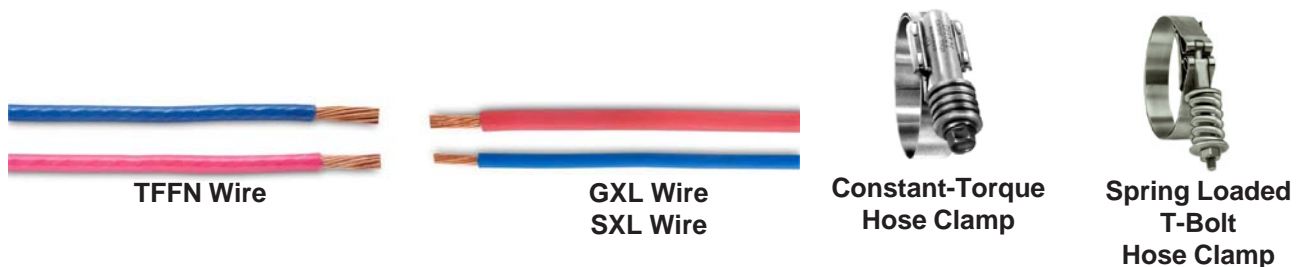

C2

PRIMARY WIRE

SAE STANDARD TYPE GPT (GENERAL PURPOSE THERMOPLASTIC)

Primary Wire features a special polyvinyl chloride compound to insulate the copper conductor. This material is especially suited to resist heat, oil, abrasion and aging. The construction permits small diameters for easy cabling and has a smooth, lustrous surface in a wide range of colors. Stranded annealed, single conductor copper wire. Recommended for car, truck, tractor and marine use. For use at 60 Volts or less. Temperature rating 80°C (176°F). Meets SAE J1128 specifications. **RoHS compliant.** Available in 100', 500' or 1000' Spools. Larger spools and Drum Packs are available upon request.



SAMPLE PART NUMBER

PW10-BLK (Standard=100' SPOOL)
 PW10D-BLK (D=500' SPOOL)
 PW10M-BLK (M=1000' SPOOL)

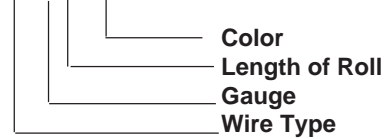

WIRE CAPACITIES

GAUGE	CONTINUOUS LIGHT DUTY
20	1.5 amp
18	3 amp
16	6 amp
14	15 amp
12	20 amp
10	25 amp
8	35 amp
6	50 amp

Striping Available - Minimum 1000'

Other colors available upon request

WIRE GAUGE	STRANDING	NOMINAL O.D.	INSULATION THICKNESS	WT PER 1000FT	COLORS
20	10/30	.085	.023	7 lbs	Black, Red, White
18	16/30	.095	.023	9 lbs	Black, Blue, Brown, Gray, Green, Orange, Pink, Purple, Red, White, Yellow
16	19/29	.102	.023	12 lbs	Black, Blue, Dark Blue, Brown, Gray, Green, Dark Green, Orange, Pink, Purple, Red, White, Yellow
14	19/27	.117	.023	19 lbs	Black, Blue, Dark Blue, Brown, Gray, Green, Dark Green, Orange, Pink, Purple, Red, Tan, White, Yellow
12	19/25	.142	.026	28 lbs	Black, Blue, Brown, Gray, Green, Orange, Red, White, Yellow
10	19/23	.174	.031	42 lbs	Black, Blue, Green, Red, White, Yellow
8	19/21	.215	.037	68 lbs	Black, Red, White

PACKAGED PRIMARY WIRE (Smaller Spools for Retail Sales)

Our regular quality primary wire, packaged for small users in smaller quantities. Ideal for over-the-counter sales. Recommended for trucks, tractors, cars and general service. All gauges available in **Black, Blue, Brown, Green, Orange, Red, White and Yellow.** RoHS compliant.

PART#	GA	LENGTH
PWPKG-18#	18	45 ft
PWPKG-16#	16	35 ft
PWPKG-14#	14	25 ft
PWPKG-12#	12	15 ft
PWPKG-10#	10	10 ft



represents the color

State Wire and Terminal, Inc.

TRAILER CABLE

C3

TRAILER CABLE conductors are stranded copper and color coded for identification purposes. Meets SAE J1128. RoHS compliant. Available in 100', 500' spools and factory reels. Meets SAE J1128

Tough plastic jacket with good resistance to abrasion, oil, grease, acid and weather. Exterior Jacket colors for easy identification include standard Black and Green (ABS Braking Systems)



Superior flex TPE (Thermoplastic Elastomer) jacket for excellent weather, oil and grease resistance. Exterior Jacket color for easy identification is Blue (Cold Weather).

PART#	JACKET COLOR	GA	# OF COND.	NOM O.D.	MAX VOLTS	MAX TEMP	MIN TEMP	STRANDING	JACKET MATERIAL
TC-16/6	Black	16	6	0.425	60	80°C/176°F	-65°C / -85°F	19/29	Plastic
TC-16/4	Black	16	4	0.360	60	80°C/176°F	-65°C / -85°F	19/29	Plastic
TC-14/7	Black	14	7	0.500	60	80°C/176°F	-65°C / -85°F	19/27	Plastic
TC-14/6	Black	14	6	0.500	60	80°C/176°F	-65°C / -85°F	19/27	Plastic
TC-14/4	Black	14	4	0.410	60	80°C/176°F	-65°C / -85°F	19/27	Plastic
TC-12/6-10/1	Black	12	6	0.520	60	80°C/176°F	-65°C / -85°F	19/25	Plastic
		10	1					19/23	Plastic
		14	4	0.560	60	80°C/176°F	-65°C / -85°F	19/27	Plastic
TC-7RV FOR RV SYSTEMS	Black	12	1		60	80°C/176°F	-65°C / -85°F	19/25	Plastic
		10	2		60	80°C/176°F	-65°C / -85°F	19/23	Plastic
		12	4	0.690	60	80°C/176°F	-50°C / -58°F	65/30	Plastic
TC-7ABS FOR ABS BRAKING SYSTEMS	Green	10	2			80°C/176°F	-50°C / -58°F	105/30	Plastic
		8	1			80°C/176°F	-50°C / -58°F	168/30	Plastic
		14	7	0.520	48	105°C/221°F	-50°C / -58°F	19/27	TPE
TC-BLU14/6	Blue	14	6	0.490	48	105°C/221°F	-50°C / -58°F	19/27	TPE

# OF COND.	COLOR CODE
4 Conductor	Yellow / Red / Green / Brown
6 Conductor	Red / Blue / Green / Yellow / Black / Brown
7 Conductor	Red / Green / Brown / White / Black / Yellow / Blue
NOTE:	1st Color listed is in the midnight position.

COILED CABLE ASSEMBLY WITHOUT ENDS



PART#	WORKING LENGTH	GA	# OF COND.	JACKET
TCA-16/5X20NE	20'	16	5	EPDM

Other conductors available.

MULTI-CONDUCTOR BOAT CABLE

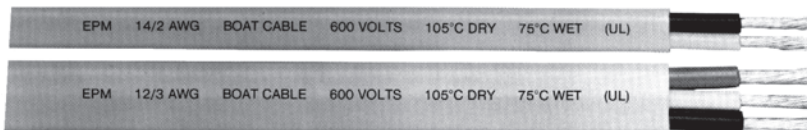

White Exterior Jacket

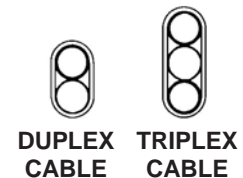

PART#	GAUGE	STRANDING	NOMINAL O.D.	COLOR CODE
JW-BC16/2	16	26/30	.205 x .328	Black-White
JW-BC16/3	16	26/30	.205 x .450	Black-Green-White
JW-BC14/2	14	41/30	.221 x .362	Black-White
JW-BC14/3	14	41/30	.221 x .503	Black-Green-White
JW-BC12/2	12	65/30	.245 x .410	Black-White
JW-BC12/3	12	65/30	.245 x .575	Black-Green-White
JW-BC10/2	10	105/30	.273 x .466	Black-White
JW-BC10/3	10	105/30	.273 x .659	Black-Green-White



UL Listed #1426 boat cable is rated 600 volts and meets Coast Guard specifications for electrical systems. It is rated for temperatures up to 105°C (221°F) dry and 75°C (167°F) wet. Cable has electro-tinned, plated copper strands for greater corrosion protection. Each conductor is insulated and jacketed with flame retardant PVC for internal wiring of electrical and electronic systems. Available in 100ft, 500ft, 1000ft and factory reels. 2 Conductor also available in Red/Black or Yellow/Red combinations. RoHS compliant.

Toll Free: 800-922-6527 • Fax: 248-634-2022 • www.statewire.com

C4

JACKETED WIRE

JACKETED WIRE is made with multiple primary wires laid parallel and covered with a high quality plastic jacket. The jacket provides a compact cable, oblong in shape, where more than one conductor is required and protects the insulated conductors against weather and acid conditions. 50 Volts. Meets SAE J1128. For temperatures -30°C (-22°F) to 105°C (221°F). Available in 100ft, 500ft, 1000ft and Factory reels. RoHS compliant.

PART#	GAUGE	NUMBER OF CONDUCTORS	INTERIOR COLOR-CODE	EXTERIOR INSULATION
JW-18/2D	18	2	Black-Red	Gray
JW-16/2	16	2	Black-White	Gray
JW-16/3	16	3	Green-Black-White	Gray
JW-16/4	16	4	Red-Green-Black-White	Gray
JW-14/2-GRY	14	2	Black-White	Gray
JW-14/3	14	3	Green-Black-White	Gray
JW-14/4	14	4	Red-Green-Black-White	Gray
JW-12/2-BB	12	2	Blue-Black (Brake Control)	Red
JW-12/2-DB-BB*	12	2	Blue-Black (Brake Control)	Black
JW-12/2-GRY	12	2	Black-White	Gray
JW-12/3	12	3	Green-Black-White	Gray
JW-10/2	10	2	Black-White	Gray
JW-8/2	8	2	Black-White	Gray

* Minimum 500 FT



COPPER CONDUCTOR AWG SELECTION GUIDE

AMPS	Electrode Distance from Welding Equipment (Feet)								
	50	75	100	125	150	200	250	300	350
100	4	4	2	2	1	1/0	2/0	3/0	4/0
150	3	3	1	1/0	2/0	3/0	4/0		
200	2	1	1/0	2/0	3/0	4/0			
250	1	1/0	2/0	3/0	4/0				
300	1	2/0	3/0	4/0					
350	1/0	3/0	4/0						
400	2/0	3/0	4/0						
450	2/0	4/0							
500	3/0	4/0							
600	4/0								

WELDING CABLE

Soft, high flexibility at low temperatures. Ultimate in electrical protection and resistance to common damaging elements. Black or red insulation. 600V. For temperatures -50°C (-58°F) to 105°C (221°F). Larger spools available. RoHS compliant.

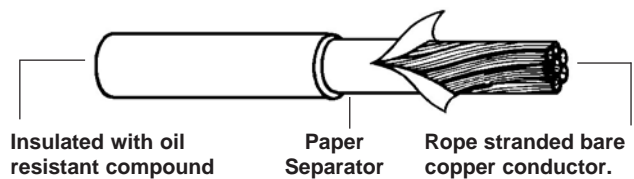

PART# BLACK	PART# RED	STRANDING	NOMINAL O.D.	GAUGE	STD PKG
WC-6	WC-6R	7 X 38/30	0.305	6	100
WC-4	WC-4R	7 X 56/30	0.340	4	100
WC-2	WC-2R	7 X 92/30	0.420	2	50
WC-1		7 X 112/30	0.490	1	50
WC-1/0	WC-1/0R	19 X 54/30	0.525	0	50
WC-2/0	WC-2/0R	19 X 66/30	0.570	00	50
WC-3/0	WC-3/0R	19 X 85/30	0.635	000	50
WC-4/0	WC-4/0R	19 X 108/30	0.695	0000	50



State Wire and Terminal, Inc.

BATTERY CABLES

C5

Insulated starter cable with paper wrapping. Full gauge copper conductor. Tough, high temperature PVC insulation for use at 60 volts or less. Red or black plastic, stranded copper. Recommended for connecting battery to switch, starter to ground. Meets SAE J1127 specifications. For temperatures -50°C (-58°F) to 105°C (221°F). Larger spools available. RoHS compliant.

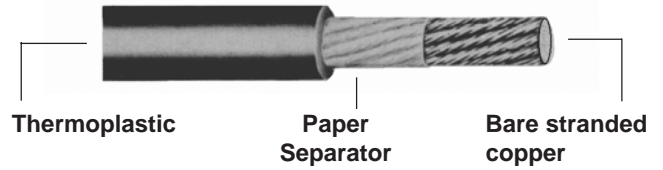

PART# BLACK	PART# RED	STRANDING	NOMINAL O.D.	GAUGE	STD PKG
BC-6	BC-6R	49/23	0.330	6	100
BC-4	BC-4R	70/23	0.380	4	100
BC-2	BC-2R	133/23	0.450	2	50
BC-1	BC-1R	133/22	0.490	1	50
BC-1/0	BC-1/0R	133/21	0.550	0	50
BC-2/0	BC-2/0R	133/20	0.605	00	50



BATTERY HARNESS



PART# EP-4320
14" Length. Black. 2/0 Gauge for 3/8 stud. Includes four 3/8" hex serrated flange nuts and 1 charging post for 3/8" stud-type battery. Length is center of outside hole to center of outside hole. **Sold Individually**

BATTERY TERMINAL COVERS



FITS 4GA TO 6GA WIRE

PART#	COLOR
BTE-CB	Black
BTE-CR	Red

Sold Individually

GROUND STRAPS



PART#	LENGTH
EP-L13	13.5"
EP-L16	16.5"

2 Gauge.
Sold Individually

BONDING STRAPS



PART# EP-E12
12" Length. 4 Gauge.
Sold Individually

GOLF CAR CABLES

PART #	LENGTH
EP-GSC9	9"
EP-GSC12	12"
EP-GSC20	20"



Type EP-GSC

6 Gauge.
Red Thermal Plastic Insulation.
Sold Individually

SWITCH TO STARTER CABLES



Can be used for automotive and marine applications. Red thermal plastic insulation. 4 Gauge for 3/8" Stud. **Sold Individually.**

PART#	LENGTH
EP-SS16	16"
EP-SS18	18"
EP-SS32	32"
EP-SS49	49"

HEAVY WALL STARTER CABLES

Red or black thermal plastic insulation. Lead top post. Available in 4 gauge and 2 gauge. 3/8" Stud. **Sold Individually.**

4 Gauge

RED PART#	BLACK PART#	LENGTH
EP-B12		12"
	EP-B38BLK	38"
EP-B48		48"
EP-B65		65"



SIDE TERMINAL BATTERY CABLES



PART#	LENGTH
EP-ST50	50"
EP-ST65	65"

Red thermal plastic insulation. (Also available in black thermal plastic insulation.) The lug end of the cable can be bent to various angles for connection to ground or starter. All side terminal cables have a 4 inch -12 gauge auxiliary lead. Bolt included. **Sold Individually.**

2 Gauge

RED PART#	BLACK PART#	LENGTH
EP-S10		10"
EP-S15		15"
EP-S20		20"
EP-S23	EP-S23BLK	23"
	EP-S27BLK	27"
	EP-S34BLK	34"
EP-S43		43"
EP-S48		48"



OTHER LENGTHS AVAILABLE UPON REQUEST

Toll Free: 800-922-6527 • Fax: 248-634-2022 • www.statewire.com

C6

RIPCORDER WIRE

Parallel copper stranded RIPCORDER is constructed of multiple standard wall primary wires bonded or extruded side by side so that the wires are held together by thermoplastic insulation. Each conductor is color-coded for identification purposes. The wires are easily separated. This parallel primary wire is very economical and convenient for use in wiring assemblies and whenever a multi-conductor primary wire is needed. Meets J1128. Temperatures up to 80°C (176°F). 50 Volts or less. **RoHS Compliant. Made in the USA. Available in 100, 500, 1000 and other special lengths.**



PART#	WIRE GA	# OF COND	STRANDING	OUTSIDE DIAMETER	WT PER 1000FT	AVAILABLE COLORS
RC18/2	18	2	16/30	.095 X .190	16	Black-Red
RC18/4	18	4	16/30	.095 X .380	32	Green-Yellow-Brown-White
RC16/2	16	2	19/29	.105 X .210	22	Black-Red
RC16/3	16	3	19/29	.105 X .315	33	Green-Yellow-Brown
RC16/4	16	4	19/29	.105 X .420	44	Green-Yellow-Brown-White
RC14/2	14	2	19/27	.122 X .244	32	Black-Red
RC14/3	14	3	19/27	.122 X .366	47	Green-Yellow-Brown
RC14/4	14	4	19/27	.122 X .488	64	Green-Yellow-Brown-White
RC12/2	12	2	19/25	.138 X .280	48	Black-Red

Other color combinations available upon request. Minimum order quantities may apply.

Extruded Parallel Wire. Meets J1128 specifications. This parallel starter cable is very economical and convenient for use in wiring assemblies and whenever a multi-conductor wire is needed. 60 Volts. **Excellent for making jumper cable sets. 100 Foot Spools.**

PART#	WIRE GA	# OF COND	STRANDING	OUTSIDE DIAMETER	INSULATION	TEMPERATURE	COLORS
JC6/2-ORG/BLK	6	2	7 x 19/27	.360 X .780	PVC	80°C / 176°F	Orange / Black
JCR6/2-RED/BLK	6	2	259 / 30	.320 X .650	TPE	105°C / 221°F	Red / Black

COAXIAL CABLES	
<p>RG6Q</p> <p><i>Cable Cross-section: (NOT TO SCALE)</i></p> <p>Quad Shield. 18 AWG Copper clad steel conductor.</p>	
<p>RG6Q/2</p> <p><i>Cable Cross-section: (NOT TO SCALE)</i></p> <p>Dual Quad Shield. 2 X 18 AWG Copper clad steel conductor.</p>	
<p>RG6 type multi-use coaxial cable. 18 AWG Copper clad steel conductor. Quad shielded with 2 foil wraps plus 40% and 60% aluminum braids. Foam polyethylene insulation with black PVC jacket. ETL dual listed as CM/CL2 and CATV: UL 13, 444, and 1655 Swept to 3.0 GHz. Available in 100ft, 500ft and 1000ft spools.</p>	

COMMERCIAL COAX CONNECTORS		
<p>RG6-323003</p> <p>Coaxial End Male Crimpless Twist-On. Std Package: 10</p>	<p>RG6-322990</p> <p>1/2 Ring. Coaxial End Male Crimp-On. Std Package: 10</p>	<p>RG6-32412</p> <p>1/4 Ring. Coaxial End Male Crimp-On. Std Package: 10</p>
<p>Note: For information on the COAX CRIMP TOOL and the RATCHETING COAX CRIMP TOOL, refer to Page H2</p>		

SPEAKER WIRE

SPEAKER WIRE is made with top grade stranded copper wire in clear plastic insulation with tracer stripe or tinned for polarity. PVC insulated for use with audio equipment. **RoHS Compliant. Made in the USA.** Available in 100, 500 & 1000 Foot Spools.

PART#	GAUGE	STRANDING
SW-18/2	18	16/30
SW-16/2	16	26/30
SW-12/2	12	65/30



TUBING, LOOM AND POWER CORD C7

POWER CORD

Black CPE (chlorinated polyethylene) exterior insulation. Has an EPDM (Ethylene Propylene) wire insulation. Used for Air conditioners, office equipment, portable tools, refrigerators, sanders and welders. For temperatures - 40°C (-40°F) to 90°C (194°F). 100 and 250 Foot lengths. Other sizes available on request.

PART#	STRANDING	NOMINAL		COLOR CODE
		O.D.	VOLTS	
SJOOW-18/3	16/30	.300	300	Black-White-Green
SJOOW-16/2	26/30	.310	300	Black-White
SJOOW-16/3	26/30	.330	300	Black-White-Green
SJOOW-14/2	41/30	.340	300	Black-White
SJOOW-14/3	41/30	.360	300	Black-White-Green
SJOOW-12/3	65/30	.430	300	Black-White-Green
SJOOW-10/3	103/30	.580	300	Black-White-Green

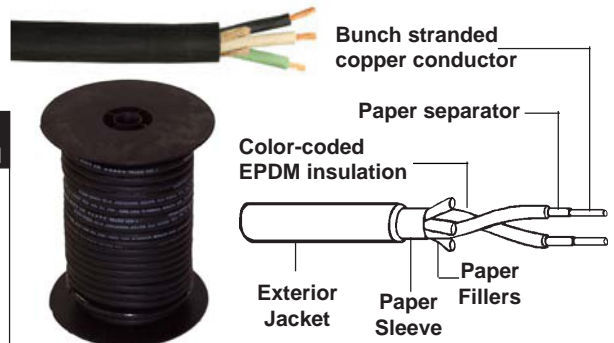

SPLIT LOOM



TO ORDER BULK SPOOLS:
add "D" for 500 feet or
add "M" for 1000 feet

Easy to use, split loom offers excellent protection for wire, cable, tubing, hoses and other fragile surfaces. It's light in weight, but the convoluted surface provides heavy duty protection from abrasion and pinching. You can enhance your product with uniform appearance. Split loom is slit the full length and slides easily over your assembly.

POLYETHYLENE, usable at a maximum temperature of 200°F (93°C), **NYLON** at 250°F (121°C) or **HI-TEMPERATURE NYLON with gray stripe** for temperatures up to 300°F (149°C).

200° F POLY PART #	300° F NYLON PART#	ID	OD	STD PKG
SPL-1/8		.125	.280	100
SPL-1/4	SPL-HT1/4	.250	.400	100
SPL-5/16		.350	.510	100
SPL-3/8	SPL-HT3/8	.413	.594	100
SPL-1/2	SPL-HT1/2	.500	.695	100
SPL-5/8	SPL-HT5/8	.625	.830	50
	SPL-HT3/4	.750	.980	50
SPL-1HD	SPL-HT1	1.000	1.270	50
	SPL-HT1-1/4	1.250	1.480	50
	SPL-HT1-1/2	1.500	1.795	50
SPL-2		2.000	2.375	25

Inside Diameters

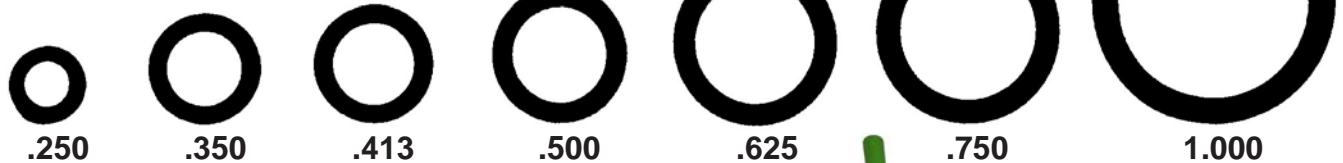

SPLIT LOOM INSERTION TOOL

Tools allow for quick easy installation of wire and cable. First, insert all cables in the applicator, insert the end of the tubing into the top of the applicator, and then bring your hand back toward you. All cables are inside the tubing. Installation tools are available in multiple sizes for split tubing up to 7/8" I.D. **Sold Individually.**



PART#	SIZE RANGE
SPL-T08	1/4" - 7/16"
SPL-T15	1/2" - 5/8"
SPL-T20	3/4" - 7/8"

FLEX EXPANDABLE SLEEVING (BLACK)

PART#	NOMINAL		STD PKG
	SIZE	RANGE	
FLEX18BLK	1/8"	3-32"-1/4"	100
FLEX14BLK	1/4"	1/8"-7/16"	100
FLEX38BLK	3/8"	3/16"-5/8"	100
FLEX12BLK	1/2"	1/4"-3/4"	100
FLEX34BLK	3/4"	1/2"-1-1/4"	100
FLEX114BLK	1-1/4"	3/4"-1-3/4"	100
FLEX112BLK	1-1/2"	1"- 2-1/2"	50
FLEX2BLK	2"	1-1/2"- 3-1/2"	50



Flex expandable sleeving is a lightweight jacketing for bundling and protecting wires, cables and hoses. Braided from .010" polyester monofilament yarns with a continuous operating temperature of 125°C (257°F). Flex offers total protection for wire and cable assemblies. The open braid feature allows easy visual inspection and quick repair. The unique expansion characteristic makes it easy to slip on. Only a few sizes are needed to cover a large range since each size expands up to **three** times its normal diameter. Flex offers good abrasion protection while maintaining its lightweight, self-fitting flexible feature. It is durable, easy to apply and cost effective. Resists gasoline, cleaning solvents and engine chemicals. Other colors available.

Toll Free: 800-922-6527 • Fax: 248-634-2022 • www.statewire.com

C8 HEAT SHRINK TUBING AND HOSES

REGULAR WALL

Polyolefin tubing shrinks with 2 to 1 ratio. (Diameters listed are before shrinkage.) 10ft lengths and 100ft spools

BLACK PART#	RED PART#	INSIDE DIAMETER
ST-1/16		1/16"
ST-3/32		3/32"
ST-1/8		1/8"
ST-3/16		3/16"
ST-1/4		1/4"
ST-3/8	ST-3/8R	3/8"
ST-1/2	ST-1/2R	1/2"
ST-3/4	ST-3/4R	3/4"
ST-1	ST-1R	1"

STANDARD MULTI-WALL

Shrinks with a 3 to 1 ratio for weather-proof connections and has a meltable sealant to permanently protect electrical connections. Wall Thickness after shrinking is 1/16". 1ft lengths.

BLACK PART#	RED PART#	CLEAR PART#	INSIDE DIAMETER
ST-MW1/8	ST-MW1/8R		1/8"
ST-MW3/16	ST-MW3/16R	ST-MW3/16C	3/16"
ST-MW1/4	ST-MW1/4R	ST-MW1/4C	1/4"
ST-MW3/8	ST-MW3/8R	ST-MW3/8C	3/8"
ST-MW1/2	ST-MW1/2R	ST-MW1/2C	1/2"
ST-MW3/4	ST-MW3/4R		3/4"
ST-MW1	ST-MW1R		1"

SIZE TABLE

TERMINAL GAUGE	SHRINK TUBE SIZE
22-18	1/4
16-14	1/4
12-10	3/8
8	3/8
6	3/8
4	1/2
2	3/4
1	3/4
1/0	3/4
2/0	1
3/0	1
4/0	1

TINTED MULTI-WALL

PART#	GAUGE	I.D.	COLOR
ST-MW1820	18-20	.245	Pink
ST-MW1416	14-16	.245	Blue
ST-MW1012	10-12	.360	Yellow

Semi-Rigid, Adhesive-lined. Color Coded. 6" lengths.

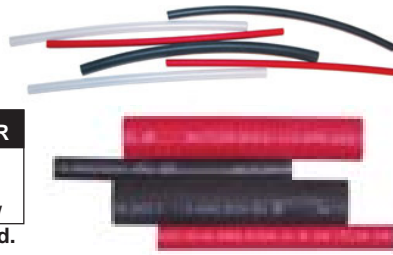

ALL SHRINK TUBE IS POLYOLEFIN

PACKAGED MULTI-WALL

BLACK PART#	RED PART#	INSIDE DIAMETER
ST-MW316PKG	ST-MW316RPKG	3/16"
ST-MW14PKG	ST-MW14RPKG	1/4"
ST-MW38PKG	ST-MW38RPKG	3/8"
ST-MW12PKG	ST-MW12RPKG	1/2"
ST-MW34PKG	ST-MW34RPKG	3/4"
ST-MW1PKG	ST-MW1RPKG	1"

Ten 1-1/2" pieces per package.

HEAT GUN

PART# ST-GUN

Commercial grade heat gun with deflector.

Dual temperature: 750°F or 1000°F. 120 Volts - 1200 Watts. UL and CSA approved.



HEAVY DUTY MULTI-WALL

BLACK PART#	RED PART#	INSIDE DIAMETER	WALL THICKNESS
ST-MWHD3/8		3/8"	.09"
ST-MWHD3/4	ST-MWHD3/4R	3/4"	.11"
ST-MWHD1	ST-MWHD1R	1"	.12"

1ft lengths.

Ask about sizes and lengths not shown. See Page G4 for our Shrink Tube Assortments

FUEL LINE AND VAPOR EMISSION HOSE

Gives years of service on all types of gasoline engines. Vapor emission properties are excellent for applications in cars and trucks where petroleum vapors and blow-by gases are recirculated through intake manifold. **High quality Hypalon cover provides maximum heat resistance up to 257°F** and meets OEM specifications. Nitrile tube resistant to deterioration effects of gasoline. Suitable for use with leaded and unleaded gasoline, ethanol and methanol based gasohol and diesel fuel. Meets or exceeds SAE J30R6, SAE J30R7 and GM 6165M specifications. **"Not Marine Grade."** Available in 25 Foot Spools. Special Order 50 Foot Spools.



PART#	I.D.	O.D.
FLH-3/16	3/16"	3/8"
FLH-1/4	1/4"	3/8"
FLH-5/16	5/16"	1/2"
FLH-3/8	3/8"	1/2"



WINDSHIELD WASHER AND VACUUM HOSE

Windshield washer tubing is specially compounded not to deteriorate or split from heat and ozone under the hood. Excellent oil and grease resistance. Applications include windshield washers, power antennas, defrosters, headlight vacuum systems, power seats, power windows, etc. Available in 50 Foot Spools.

PART#	I.D.	O.D.	NIPPLE SIZE
VH-3/32	3/32"	1/8"	1/8"
VH-7/64	7/64"	9/64"	1/8"
VH-5/32	5/32"	5/16"	3/16"
VH-7/32	7/32"	13/32"	1/4"
VH-9/32	9/32"	15/32"	5/16"



State Wire and Terminal, Inc.

CLAMPS

C9

HOSE CLAMPS

PARTIAL STAINLESS CLAMP - Stainless Steel Band and Housing with Plated Bolt (Hex Head Slotted).
ALL STAINLESS CLAMP - Stainless Steel Band, Housing and Bolt. **10 clamps per box.**

REGULAR CLAMP SIZES (1/2 Band)

REGULAR PART#	MINIMUM	MAXIMUM	STAINLESS STEEL PART#
HC-6	7/16"	25/32"	HCSS-6
HC-8	1/2"	29/32"	HCSS-8
HC-10	9/16"	1-1/16"	HCSS-10
HC-12	11/16"	1-1/4"	HCSS-12
HC-16	13/16"	1-1/2"	HCSS-16
HC-20	13/16"	1-3/4"	HCSS-20
HC-24	1-1/16"	2"	HCSS-24
HC-28	1-5/16"	2-1/4"	HCSS-28
HC-32	1-9/16"	2-1/2"	HCSS-32
HC-36	1-13/16"	2-3/4"	HCSS-36
HC-40	2-1/16"	3"	
HC-44	2-5/16"	3-1/4"	
HC-48	2-9/16"	3-1/2"	HCSS-48
HC-52	2-13/16"	3-3/4"	
HC-56	3-1/16"	4"	
HC-60	3-5/16"	4-1/4"	
HC-64	3-9/16"	4-1/2"	
HC-72	1-7/8"	5"	
HC-80	2-1/2"	5-1/2"	
HC-88	3-1/8"	6"	
HC-96	3-5/8"	6-1/2"	
HC-104	4-1/8"	7"	
HC-128	5-5/8"	8-1/2"	

MINI CLAMP SIZES (5/16 Band)

REGULAR PART#	MINIMUM	MAXIMUM	STAINLESS STEEL PART#
HC-M4	7/32"	5/8"	HCSS-M4
HC-M6	7/16"	25/32"	HCSS-M6
HC-M8	1/2"	29/32"	
HC-M10	9/16"	1-1/16"	HCSS-M10

Automotive - Exceeds SAE Standards for Clamps.
Plumbing - For plastic pipe and flexible hose.
Marine - Corrosive and non-corrosive applications.
Industrial - Used by Sprinkler installers and general maintenance people.



Ask about sizes not shown.

See Page G14 for our Hose Clamp Assortment



INSULATED METAL CLAMPS

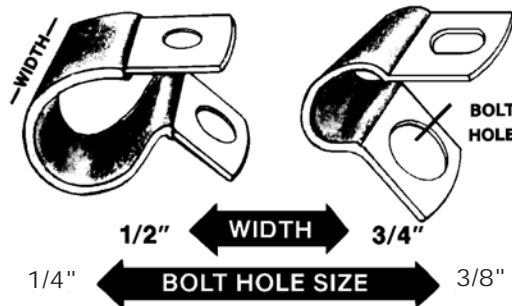

These **ZINC PLATED STEEL CLAMPS** are vinyl insulated and are available in small and large bolt hole sizes. **Sold 25 per package.** Assortment shown on page G22



PART#	INSIDE DIAMETER
RIC-S3/16	3/16"
RIC-S1/4	1/4"
RIC-S5/16	5/16"
RIC-S3/8	3/8"
RIC-S1/2	1/2"
RIC-S5/8	5/8"
RIC-S3/4	3/4"
RIC-S7/8	7/8"
RIC-S1	1"

PART #	INSIDE DIAMETER
RIC-L1/4	1/4"
RIC-L5/16	5/16"
RIC-L3/8	3/8"
RIC-L1/2	1/2"
RIC-L5/8	5/8"
RIC-L3/4	3/4"
RIC-L7/8	7/8"
RIC-L1	1"
RIC-L1-1/4	1-1/4"
RIC-L1-1/2	1-1/2"

PART #	INSIDE DIAMETER	CLAMP WIDTH
RIC-S1/4SLV	1/4"	1/2"
RIC-S3/8SLV	3/8"	1/2"
RIC-S1/2SLV	1/2"	1/2"
RIC-S5/8SLV	5/8"	1/2"
RIC-S3/4SLV	3/4"	1/2"
RIC-S1SLV	1"	1/2"
RIC-S1-1/2SLV	1-1/2"	1/2"
RIC-S2SLV	2"	1/2"

SLEEVED CLAMPS



Plated Steel. Durable cushion helps cut vibration. Used with hydraulic hoses, wire harnesses and cable. **Standard Package 25.**

PART #	INSIDE DIAMETER	CLAMP WIDTH
RIC-L3/4SLV	3/4"	3/4"
RIC-L1-1/4SLV	1-1/4"	3/4"
RIC-L1-3/4SLV	1-3/4"	3/4"
RIC-L2SLV	2"	3/4"
RIC-L2-1/2SLV	2-1/2"	3/4"
RIC-L3SLV	3"	3/4"

Toll Free: 800-922-6527 • Fax: 248-634-2022 • www.statewire.com

C10 CLAMPS, CLIPS & MECHANICS WIRE

NYLON CABLE CLAMPS



These molded nylon clamps provide secure holding power for a wide range of cable diameters. Their unique screw hole alignment feature speeds the installation and provides extra strength. Made of tough nylon 6/6.

WHITE PART #	BLACK PART #	INSIDE DIAMETER	STD PKG
PC-1/8	PC-B1/8	1/8"	100
PC-3/16	PC-B3/16	3/16"	100
PC-1/4	PC-B1/4	1/4"	100
PC-5/16	PC-B5/16	5/16"	100
PC-3/8	PC-B3/8	3/8"	100
PC-1/2	PC-B1/2	1/2"	100
PC-5/8	PC-B5/8	5/8"	50
PC-3/4	PC-B3/4	3/4"	50
PC-1		1"	50

PARALLEL WIRE CLAMP



PART# GC-WB
Adhesive backed clamp for mounting parallel wires. **Standard Package: 100**

GLUE-ON CLAMPS

PART #	INSIDE DIAMETER	STD PKG
GC-3/16	3/16"	100
GC-1/4	1/4"	100
GC-3/8	3/8"	50
GC-1/2	1/2"	50
GC-3/4	3/4"	25



New **LOCK/RELEASE** design simplifies installation of wire bundles and permits addition or removal of wire anytime. **Foam Adhesive Mounting** is easy to install anywhere, ready for use instantly. **No more drilling!** Suggested application temperature - 70° to 120° F. Suggested maximum service temperature -200° F.

TIE DOWNS



This quality tie down strap is made of first grade rubber polymers. Factory tested to meet or exceed SAE specifications. **Packaged 10 of each size per bundle. 50 per case.**

PART #	RUBBER LENGTH	RECOMMENDED STRETCH LENGTH	WEIGHT PER BOX
TD-10	10"	15-20"	11.00 lbs.
TD-15	15"	20-30"	13.25 lbs.
TD-21	21"	26-42"	15.50 lbs.
TD-31	31"	36-62"	18.80 lbs.

SPOOLED MECHANICS WIRE

Black annealed wire in 5# rolls.

PART #	GAUGE	LENGTH	O.D.
MW-16	16	480 ft.	.060
MW-18	18	830 ft.	.048



METAL FRAME CLIPS

These **push-on wire clips** are made of spring steel and have a black enamel finish. They are used to secure one or more wires to panel surfaces. Spring tension holds clip in place. **Standard Package - 100**



FCS-S
(Plated)



FCS



FCM



FCL

For your convenience we accept ...



State Wire and Terminal, Inc.

QUICK INDEX SECTION D

D1

Nuts & Bolts / Screws / Fasteners

- D2-3** Cap Screws Grade 5 and 8
- D4** Washers
- D5** Nuts
- D6** Nut and Bolt Assortments
- D7** Metric Cap Screws, Nuts and Washers
- D8-9** Plated Hitch Pin Clips and Bent Arm Pins
- D10** Locking, Lynch, Roll and Cotter Pins

- D11** Machine Screws
- D12** Sheet Metal Screws
- D13** Tek Screws
- D14** Stainless Steel Fasteners
- D15** Stainless Steel Screws
- D16-17** Blind Rivets, Thread Sert Assortment and Tool
- D18** Grease Fittings, Rubber and Plastic Grommets

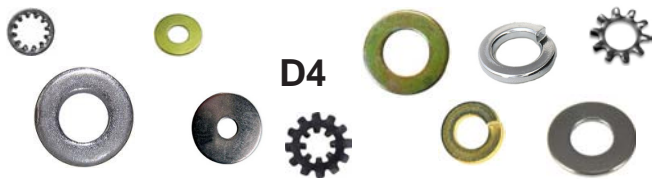

GRADE 5 HEX HEAD CAP SCREWS / COARSE THREAD

DIAMETER		1/4"	5/16"	3/8"	7/16"	1/2"	9/16"	5/8"
THREADS PER INCH		20	18	16	14	13	12	11
HEAD SIZE ACROSS FLATS (WRENCH SIZE)		7/16"	1/2"	9/16"	5/8"	3/4"	13/16"	7/8"
TENSILE STRENGTH		120,000 PSI	120,000 PSI	120,000 PSI	120,000 PSI	120,000 PSI	120,000 PSI	120,000 PSI
LENGTH	1/2"	CSC-1412	CSC-51612			CSC-1212		
	3/4"	CSC-1434	CSC-51634	CSC-3834	CSC-71634	CSC-1234		
	1"	CSC-141	CSC-5161	CSC-381	CSC-7161	CSC-121	CSC-9161	CSC-581
	1-1/4"	CSC-14114	CSC-516114	CSC-38114	CSC-716114	CSC-12114		CSC-58114
	1-1/2"	CSC-14112	CSC-516112	CSC-38112	CSC-716112	CSC-12112	CSC-916112	CSC-58112
	1-3/4"	CSC-14134	CSC-516134	CSC-38134	CSC-716134	CSC-12134		CSC-58134
	2"	CSC-142	CSC-5162	CSC-382	CSC-7162	CSC-122	CSC-9162	CSC-582
	2-1/4"	CSC-14214	CSC-516214	CSC-38214	CSC-716214	CSC-12214		CSC-58214
	2-1/2"	CSC-14212	CSC-516212	CSC-38212	CSC-716212	CSC-12212	CSC-916212	CSC-58212
	3"	CSC-143	CSC-5163	CSC-383	CSC-7163	CSC-123	CSC-9163	CSC-583
	3-1/2"	CSC-14312	CSC-516312	CSC-38312	CSC-716312	CSC-12312	CSC-916312	CSC-58312
	4"	CSC-144	CSC-5164	CSC-384	CSC-7164	CSC-124	CSC-9164	CSC-584
	4-1/2"	CSC-14412	CSC-516412	CSC-38412	CSC-716412	CSC-12412	CSC-916412	CSC-58412
5"	CSC-145	CSC-5165	CSC-385	CSC-7165	CSC-125	CSC-9165	CSC-585	

SHADED ITEMS ARE FULLY THREADED. NON SHADED ITEMS ARE PARTIALLY THREADED.

Additional sizes available upon request.

Minimum quantities may apply. Grade 5 fine thread available upon request.

STANDARD PACKAGE TABLE



DIAMETER	1/4"	5/16"	3/8"	7/16"	1/2"	9/16"	5/8"
LENGTH							
1/2"				100	50		
3/4"				100			
1"							
1-1/4"	100	100					
1-1/2"							
1-3/4"							
2"				50		25	25
2-1/4"							
2-1/2"							
3"					25		
3-1/2"			50				
4"	50	50		25			
4-1/2"							
5"							
6"				10	10		

GRADE 8 HEX HEAD CAP SCREWS / COARSE THREAD

DIAMETER	1/4"	5/16"	3/8"	7/16"	1/2"	9/16"	5/8"	3/4"	
THREADS PER INCH	20	18	16	14	13	12	11	10	
HEAD SIZE ACROSS FLATS	7/16"	1/2"	9/16"	5/8"	3/4"	13/16"	7/8"	1"	
TENSILE STRENGTH	150,000 PSI	150,000 PSI	150,000 PSI	150,000 PSI	150,000 PSI	150,000 PSI	150,000 PSI	150,000 PSI	
LENGTH	1/2"	CSC8-1412	CSC8-51612	CSC8-3812					
	5/8"	CSC8-1458	CSC8-51658	CSC8-3858					
	3/4"	CSC8-1434	CSC8-51634	CSC8-3834	CSC8-71634	CSC8-1234			
	1"	CSC8-141	CSC8-5161	CSC8-381	CSC8-7161	CSC8-121	CSC8-9161	CSC8-581	CSC8-341
	1-1/4"	CSC8-14114	CSC8-516114	CSC8-38114	CSC8-716114	CSC8-12114	CSC8-916114	CSC8-58114	
	1-1/2"	CSC8-14112	CSC8-516112	CSC8-38112	CSC8-716112	CSC8-12112	CSC8-916112	CSC8-58112	CSC8-34112
	1-3/4"	CSC8-14134	CSC8-516134	CSC8-38134	CSC8-716134	CSC8-12134	CSC8-916134	CSC8-58134	CSC8-34134
	2"	CSC8-142	CSC8-5162	CSC8-382	CSC8-7162	CSC8-122	CSC8-9162	CSC8-582	CSC8-342
	2-1/4"	CSC8-14214	CSC8-516214	CSC8-38214	CSC8-716214	CSC8-12214		CSC8-58214	CSC8-34214
	2-1/2"	CSC8-14212	CSC8-516212	CSC8-38212	CSC8-716212	CSC8-12212	CSC8-916212	CSC8-58212	CSC8-34212
	2-3/4"	CSC8-14234	CSC8-516234	CSC8-38234	CSC8-716234	CSC8-12234		CSC8-58234	
	3"	CSC8-143	CSC8-5163	CSC8-383	CSC8-7163	CSC8-123	CSC8-9163	CSC8-583	CSC8-343
	3-1/4"		CSC8-516314	CSC8-38314		CSC8-12314			
	3-1/2"	CSC8-14312	CSC8-516312	CSC8-38312	CSC8-716312	CSC8-12312	CSC8-916312	CSC8-58312	CSC8-34312
	4"	CSC8-144	CSC8-5164	CSC8-384	CSC8-7164	CSC8-124	CSC8-9164	CSC8-584	CSC8-344
	4-1/2"	CSC8-14412	CSC8-516412	CSC8-38412	CSC8-716412	CSC8-12412	CSC8-916412	CSC8-58412	CSC8-34412
5"	CSC8-145	CSC8-5165	CSC8-385	CSC8-7165	CSC8-125	CSC8-9165	CSC8-585	CSC8-345	
6"	CSC8-146	CSC8-5166	CSC8-386	CSC8-7166	CSC8-126	CSC8-9166	CSC8-586	CSC8-346	

SHADED ITEMS ARE FULLY THREADED. NON SHADED ITEMS ARE PARTIALLY THREADED.

Additional sizes available upon request. Minimum quantities may apply. Grade 8 fine thread available upon request.

STANDARD PACKAGE TABLE

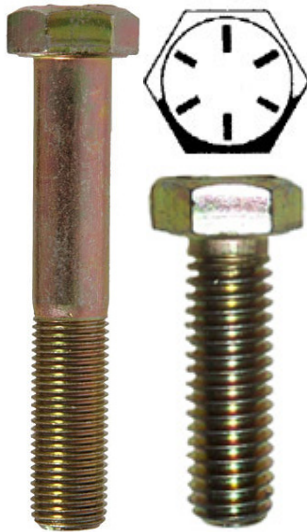

DIAMETER	1/4"	5/16"	3/8"	7/16"	1/2"	9/16"	5/8"	3/4"
LENGTH								
1/2"				100	50			
5/8"								20
3/4"			100					
1"								
1-1/4"	100	100						
1-1/2"								
1-3/4"								
2"				50		25		
2-1/4"							25	
2-1/2"								10
2-3/4"								
3"			50		25			
3-1/4"								
3-1/2"								
4"	50	50		25				
4-1/2"								
5"			25					
6"					10		10	5

USS FLAT WASHERS

USS PART#	SIZE	O.D.	STD PKG
FW-USS-10	#10	9/16"	100
FW-USS-1/4	1/4"	3/4"	100
FW-USS-5/16	5/16"	7/8"	100
FW-USS-3/8	3/8"	1"	100
FW-USS-7/16	7/16"	1-1/4"	100
FW-USS-1/2	1/2"	1-3/8"	100
FW-USS-9/16	9/16"	1-1/2"	100
FW-USS-5/8	5/8"	1-3/4"	50
FW-USS-3/4	3/4"	2"	50
FW-USS-1	1"	2-1/2"	25
FW-USS-1-1/4	1-1/4"	3"	25
FW-USS-1-1/2	1-1/2"	3-1/2"	5



GRADE 8 USS FLAT WASHERS YELLOW ZINC CHROMATE (HEAVY DUTY)

USS PART#	SIZE	O.D.	STD PKG
FW8-USS-1/4	1/4"	3/4"	100
FW8-USS-5/16	5/16"	7/8"	100
FW8-USS-3/8	3/8"	1"	100
FW8-USS-7/16	7/16"	1-1/4"	100
FW8-USS-1/2	1/2"	1-3/8"	100
FW8-USS-9/16	9/16"	1-1/2"	50
FW8-USS-5/8	5/8"	1-3/4"	50
FW8-USS-3/4	3/4"	2"	50
FW8-USS-7/8	7/8"	2-1/4"	25
FW8-USS-1	1"	2-1/2"	10



SAE FLAT WASHERS

SAE PART#	SIZE	O.D.	STD PKG
FW-SAE-4	#4	5/16"	100
FW-SAE-6	#6	3/8"	100
FW-SAE-8	#8	7/16"	100
FW-SAE-10	#10	1/2"	100
FW-SAE-12	#12	9/16"	100
FW-SAE-1/4	1/4"	5/8"	100
FW-SAE-5/16	5/16"	11/16"	100
FW-SAE-3/8	3/8"	13/16"	100
FW-SAE-7/16	7/16"	15/16"	100
FW-SAE-1/2	1/2"	1"	100
FW-SAE-9/16	9/16"	1-3/16"	100
FW-SAE-5/8	5/8"	1-5/16"	100
FW-SAE-3/4	3/4"	1-1/2"	100
FW-SAE-7/8	7/8"	1-3/4"	100
FW-SAE-1	1"	2"	50



GRADE 8 SAE PLATED FLAT WASHERS YELLOW ZINC CHROMATE (HEAVY DUTY)

SAE PART#	SIZE	O.D.	STD PKG
FW8HD-SAE-1/4	1/4"	5/8"	100
FW8HD-SAE-5/16	5/16"	11/16"	100
FW8HD-SAE-3/8	3/8"	13/16"	100
FW8HD-SAE-7/16	7/16"	15/16"	100
FW8HD-SAE-1/2	1/2"	1"	100
FW8HD-SAE-9/16	9/16"	1-3/16"	50
FW8HD-SAE-5/8	5/8"	1-5/16"	50
FW8HD-SAE-3/4	3/4"	1-1/2"	50
FW8HD-SAE-7/8	7/8"	1-3/4"	25
FW8HD-SAE-1	1"	2"	10



STAR LOCK WASHERS



EXTERNAL PART#	INTERNAL PART#	EXTERNAL-INTERNAL PART#	STUD SIZE	STD PKG
LWE-10		LWEI-10	#10	100
LWE-1/4	LWI-1/4	LWEI-1/4	1/4"	100
LWE-5/16	LWI-5/16	LWEI-5/16	5/16"	100
LWE-3/8	LWI-3/8	LWEI-3/8	3/8"	100
LWE-7/16	LWI-7/16		7/16"	100
LWE-1/2	LWI-1/2		1/2"	100
	LWI-5/8		5/8"	100

LOCK WASHERS



PART#	SIZE	STD PKG
LW-8	#8	100
LW-10	#10	100
LW-1/4	1/4"	100
LW-5/16	5/16"	100
LW-3/8	3/8"	100
LW-7/16	7/16"	100
LW-1/2	1/2"	100
LW-9/16	9/16"	100
LW-5/8	5/8"	50
LW-3/4	3/4"	50
LW-1	1"	50

GRADE 8 YELLOW ZINC LOCK WASHERS



PART#	SIZE	STD PKG
LW8-1/4	1/4"	100
LW8-5/16	5/16"	100
LW8-3/8	3/8"	100
LW8-7/16	7/16"	50
LW8-1/2	1/2"	50
LW8-9/16	9/16"	50
LW8-5/8	5/8"	25
LW8-3/4	3/4"	25
LW8-7/8	7/8"	25
LW8-1	1"	10

FENDER WASHERS

PART#	I.D.	O.D.	THICKNESS	STD PKG
FNW-316X1	3/16"	1"	.047" - .080"	100
FNW-316X114	3/16"	1-1/4"	.047" - .080"	100
FNW-14X1	1/4"	1"	.047" - .080"	100
FNW-14X114	1/4"	1-1/4"	.047" - .080"	100
FNW-14X112	1/4"	1-1/2"	.047" - .080"	100
FNW-516X114	5/16"	1-1/4"	.047" - .080"	100
FNW-516X112	5/16"	1-1/2"	.047" - .080"	100
FNW-38X112	3/8"	1-1/2"	.047" - .080"	100
FNW-12X2	1/2"	2"	.047" - .080"	100



EXTRA THICK FENDER WASHERS

PART#	I.D.	O.D.	THICKNESS	STD PKG
FNWHD-14X1	1/4"	1"	.120"	100
FNWHD-14X112	1/4"	1-1/2"	.120"	100
FNWHD-516X114	5/16"	1-1/4"	.120"	50
FNWHD-516X134	5/16"	1-3/4"	.120"	50
FNWHD-38X114	3/8"	1-1/4"	.120"	50
FNWHD-38X134	3/8"	1-3/4"	.120"	50
FNWHD-12X2	1/2"	2"	.120"	50

PREVAILING TORQUE LOCK NUTS



CLASS C - WAXED

PART#	SIZE	STD PKG
HNPTC-1/4	1/4-20	100
HNPTC-5/16	5/16-18	100
HNPTC-3/8	3/8-16	100
HNPTC-7/16	7/16-14	50
HNPTC-1/2	1/2-13	50
HNPTC-9/16	9/16-12	50
HNPTC-5/8	5/8-11	25
HNPTC-3/4	3/4-10	20
HNPTC-7/8	7/8-9	25
HNPTC-1	1-8	10

NYLON LOCK NUTS

GRADE A



USS (COARSE)		
PART#	SIZE	STD PKG
NNC-10	10-24	100
NNC-1/4	1/4-20	100
NNC-5/16	5/16-18	100
NNC-3/8	3/8-16	50
NNC-7/16	7/16-14	50
NNC-1/2	1/2-13	50
NNC-9/16	9/16-12	50
NNC-5/8	5/8-11	25
NNC-3/4	3/4-10	20
SAE (FINE)		
PART#	SIZE	STD PKG
NNF-10	10-32	100
NNF-1/4	1/4-28	100
NNF-5/16	5/16-24	100
NNF-3/8	3/8-24	100
NNF-7/16	7/16-20	50
NNF-1/2	1/2-20	50
NNF-5/8	5/8-18	25

YELLOW ZINC HEXAGON NUTS



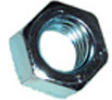

GRADE 8 COARSE		
PART#	SIZE	STD PKG
HNC8-1/4	1/4-20	100
HNC8-5/16	5/16-18	100
HNC8-3/8	3/8-16	100
HNC8-7/16	7/16-14	50
HNC8-1/2	1/2-13	50
HNC8-9/16	9/16-12	50
HNC8-5/8	5/8-11	25
HNC8-3/4	3/4-10	20
HNC8-7/8	7/8-9	15
HNC8-1	1-8	10
GRADE 8 FINE		
PART#	SIZE	STD PKG
HNFB-1/4	1/4-28	100
HNFB-5/16	5/16-24	100
HNFB-3/8	3/8-24	100
HNFB-7/16	7/16-20	50
HNFB-1/2	1/2-20	50
HNFB-5/8	5/8-18	25

HEXAGON NUTS ZINC



GRADE 5 COARSE		
PART#	SIZE	STD PKG
HNC5-1/4	1/4-20	100
HNC5-5/16	5/16-18	100
HNC5-3/8	3/8-16	100
HNC5-7/16	7/16-14	50
HNC5-1/2	1/2-13	50
HNC5-5/8	5/8-11	25
HNC5-3/4	3/4-10	20
HNC5-1	1-8	10
GRADE 5 FINE		
PART#	SIZE	STD PKG
HNFB-5/16	5/16-24	100
HNFB-3/8	3/8-24	100
HNFB-7/16	7/16-20	50
HNFB-1/2	1/2-20	50

"U" TYPE NUTS

 <p>PART # UNC-1/4 Thread Size 1/4-20 Panel Range .025-.150 Center Hole to Edge 27/32" Ford Products, Late Model Standard Package - 50</p>	 <p>PART # UNC-5/16 Thread Size 5/16-18 Panel Range .025-.150 Center Hole to Edge 7/8" GM & Ford Products, Late Model Standard Package - 25</p>	 <p>PART # UNC-3/8 Thread Size 3/8-16 Panel Range .025-.200 Center Hole to Edge 1-1/8" Ford Products, Late Model Standard Package - 25</p>
---	---	---

GENERAL PURPOSE SPRING NUTS (UNPLATED)



PART#	THREAD SIZE	PANEL RANGE	CENTER HOLD TO EDGE	STD PKG
SN-6	No. 6	.025/.125	3/8"	100
SN-8	No. 8	.025/.125	3/8"	100

LICENSE PLATE - BOLT AND NUT



PART#: LPB-HN
1/4" - 20 x 1/2" Zinc
Truss Philips Bolt;
with Hex Nut.
Standard Package: 100



PART#: LPB-SN
1/4" - 20 x 1/2" Zinc
Truss Philips Bolt; with
Square Nut.
Standard Package: 100

CASE HARDENED SERRATED FLANGE NUTS



PART#	THREAD SIZE	STD PKG
HNCFL-10	10-24	100
HNCFL-1/4	1/4-20	100
HNCFL-5/16	5/16-18	100
HNCFL-3/8	3/8-16	100
HNCFL-1/2	1/2-13	25
HNCFL-5/8	5/8-11	25

MACHINE NUTS



PART#	SIZE	STD PKG
MHN-632	6-32	100
MHN-832	8-32	100
MHN-1024	10-24	100
MHN-1032	10-32	100
MHN-1224	12-24	100
MHN-1420	1/4-20	100

FORGED WING NUTS



USS (Coarse)		
PART#	SIZE	STD PKG
WNC-1/4	1/4-20	100
WNC-5/16	5/16-18	50
WNC-3/8	3/8-16	50
WNC-1/2	1/2-13	25

KEP NUTS



PART#	SIZE	STD PKG
KNC-6	6-32	100
KNC-8	8-32	100
KNC-10	10-24	100
KNC-1/4	1/4-20	100
KNC-5/16	5/16-18	100
KNC-3/8	3/8-16	100

D6 NUT AND BOLT ASSORTMENTS

PART# HB-40AST

2500 Piece assorted zinc plated GRADE 5 nuts, bolts and washers 1/4 - 1/2. Includes the bin (HB-40) and labels. Bin Size: 35-1/4"W x 9"D x 24"H. All Items are tested, certified and zinc plated.



PART# HB-80AST

3175 Piece assorted zinc plated GRADE 5 nuts, bolts and washers 1/4 - 1/2. Includes 2 bins (HB-40) and labels. Bin Size: 35-1/4"W x 9"D x 24"H. All Items are tested, certified and zinc plated.

PART# HB8-40AST

2500 Piece assorted zinc plated GRADE 8 nuts, bolts and washers 1/4 - 1/2. Includes the bin (HB-40) and labels. Bin Size: 35-1/4"W x 9"D x 24"H. All Items are tested, certified and zinc plated.

PART# HB8-80AST

3175 Piece assorted zinc plated GRADE 8 nuts, bolts and washers 1/4 - 1/2. Includes 2 bins (HB-40) and labels. Bin Size: 35-1/4"W x 9"D x 24"H. All Items are tested, certified and zinc plated.

PART#	SIZE	HB-40AST QTY	HB-80AST QTY
CAP SCREWS			
CSC-1434	1/4-20 X 3/4		100
CSC-141	1/4-20 X 1	100	100
CSC-14114	1/4-20 X 1-1/4		100
CSC-14112	1/4-20 X 1-1/2	100	100
CSC-142	1/4-20 X 2	100	100
CSC-14212	1/4-20 X 2-1/2	100	100
CSC-5161	5/16-18 X 1	100	100
CSC-516112	5/16-18 X 1-1/2	100	100
CSC-5162	5/16-18 X 2	50	50
CSC-516212	5/16-18 X 2-1/2		50
CSC-5163	5/16-18 X 3		50
CSC-516312	5/16-18 X 3-1/2		50
CSC-381	3/8-16 X 1	50	50
CSC-38112	3/8-16 X 1-1/2	50	50
CSC-382	3/8-16 X 2	50	50
CSC-38212	3/8-16 X 2-1/2		50
CSC-383	3/8-16 X 3		50
CSC-38312	3/8-16 X 3-1/2		50
CSC-7161	7/16-14 X 1	50	50
CSC-716112	7/16-14 X 1-1/2	50	50
CSC-7162	7/16-14 X 2	25	25
CSC-716212	7/16-14 X 2-1/2		25
CSC-7163	7/16-14 X 3		25
CSC-716312	7/16-14 X 3-1/2		25
CSC-121	1/2-13 X 1	50	50
CSC-12112	1/2-13 X 1-1/2	25	25
CSC-122	1/2-13 X 2		25
CSC-12212	1/2-13 X 2-1/2		25
CSC-123	1/2-13 X 3		25
CSC-12312	1/2-13 X 3-1/2		25
FLAT WASHERS			
FW-USS-1/4	1/4	100	100
FW-USS-5/16	5/16	100	100
FW-USS-3/8	3/8	100	100
FW-USS-7/16	7/16	100	100
FW-USS-1/2	1/2	100	100
HEX NUTS			
HNC5-1/4	1/4-20	100	100
HNC5-5/16	5/16-18	100	100
HNC5-3/8	3/8-16	100	100
HNC5-7/16	7/16-14	100	100
HNC5-1/2	1/2-13	100	100
LOCK WASHERS			
LW-1/4	1/4	100	100
LW-5/16	5/16	100	100
LW-3/8	3/8	100	100
LW-7/16	7/16	100	100
LW-1/2	1/2	100	100
HB-40 BIN		1	2

PART#	SIZE	HB8-40AST QTY	HB8-80AST QTY
CAP SCREWS			
CSC8-1434	1/4-20 X 3/4		100
CSC8-141	1/4-20 X 1	100	100
CSC8-14114	1/4-20 X 1-1/4		100
CSC8-14112	1/4-20 X 1-1/2	100	100
CSC8-142	1/4-20 X 2	100	100
CSC8-14212	1/4-20 X 2-1/2	100	100
CSC8-5161	5/16-18 X 1	100	100
CSC8-516112	5/16-18 X 1-1/2	100	100
CSC8-5162	5/16-18 X 2	50	50
CSC8-516212	5/16-18 X 2-1/2		50
CSC8-5163	5/16-18 X 3		50
CSC8-516312	5/16-18 X 3-1/2		50
CSC8-381	3/8-16 X 1	50	50
CSC8-38112	3/8-16 X 1-1/2	50	50
CSC8-382	3/8-16 X 2	50	50
CSC8-38212	3/8-16 X 2-1/2		50
CSC8-383	3/8-16 X 3		50
CSC8-38312	3/8-16 X 3-1/2		50
CSC8-7161	7/16-14 X 1	50	50
CSC8-716112	7/16-14 X 1-1/2	50	50
CSC8-7162	7/16-14 X 2	25	25
CSC8-716212	7/16-14 X 2-1/2		25
CSC8-7163	7/16-14 X 3		25
CSC8-716312	7/16-14 X 3-1/2		25
CSC8-121	1/2-13 X 1	50	50
CSC8-12112	1/2-13 X 1-1/2	25	25
CSC8-122	1/2-13 X 2		25
CSC8-12212	1/2-13 X 2-1/2		25
CSC8-123	1/2-13 X 3		25
CSC8-12312	1/2-13 X 3-1/2		25
FLAT WASHERS			
FW8-USS-1/4	1/4	100	100
FW8-USS-5/16	5/16	100	100
FW8-USS-3/8	3/8	100	100
FW8-USS-7/16	7/16	100	100
FW8-USS-1/2	1/2	100	100
HEX NUTS			
HNC8-1/4	1/4-20	100	100
HNC8-5/16	5/16-18	100	100
HNC8-3/8	3/8-16	100	100
HNC8-7/16	7/16-14	100	100
HNC8-1/2	1/2-13	100	100
LOCK WASHERS			
LW8-1/4	1/4	100	100
LW8-5/16	5/16	100	100
LW8-3/8	3/8	100	100
LW8-7/16	7/16	100	100
LW8-1/2	1/2	100	100
HB-40 BIN		1	2

HEX HEAD CAPSCREWS

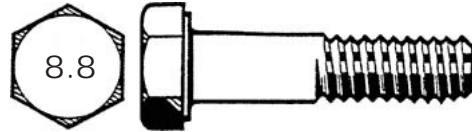

CARBON
STEEL



REGULAR PITCH — GRADE 8.8

PART#	DIA.	PITCH	HEAD	LENGTH	STD PKG
CSM-5X10	5MM	.80	8MM	10MM	100
CSM-5X20	5MM	.80	8MM	20MM	100
CSM-5X25	5MM	.80	8MM	25MM	100
CSM-5X30	5MM	.80	8MM	30MM	100
CSM-6X10	6MM	1.0	10MM	10MM	100
CSM-6X12	6MM	1.0	10MM	12MM	100
CSM-6X16	6MM	1.0	10MM	16MM	100
CSM-6X20	6MM	1.0	10MM	20MM	100
CSM-6X25	6MM	1.0	10MM	25MM	100
CSM-6X30	6MM	1.0	10MM	30MM	100
CSM-6X35	6MM	1.0	10MM	35MM	100
CSM-6X40	6MM	1.0	10MM	40MM	100
CSM-6X45	6MM	1.0	10MM	45MM	100
CSM-8X10	8MM	1.25	13MM	10MM	100
CSM-8X12	8MM	1.25	13MM	12MM	100
CSM-8X16	8MM	1.25	13MM	16MM	50
CSM-8X20	8MM	1.25	13MM	20MM	50
CSM-8X25	8MM	1.25	13MM	25MM	50
CSM-8X30	8MM	1.25	13MM	30MM	50
CSM-8X35	8MM	1.25	13MM	35MM	50
CSM-8X40	8MM	1.25	13MM	40MM	50
CSM-8X45	8MM	1.25	13MM	45MM	50
CSM-8X50	8MM	1.25	13MM	50MM	50

PART#	DIA.	PITCH	HEAD	LENGTH	STD PKG
CSM-10X20	10MM	1.50	16MM	20MM	50
CSM-10X25	10MM	1.50	16MM	25MM	50
CSM-10X30	10MM	1.50	16MM	30MM	50
CSM-10X35	10MM	1.50	16MM	35MM	50
CSM-10X40	10MM	1.50	16MM	40MM	50
CSM-10X45	10MM	1.50	16MM	45MM	25
CSM-10X50	10MM	1.50	16MM	50MM	25
CSM-10X55	10MM	1.50	16MM	55MM	25
CSM-10X60	10MM	1.50	16MM	60MM	25
CSM-12X25	12MM	1.75	18MM	25MM	25
CSM-12X30	12MM	1.75	18MM	30MM	25
CSM-12X35	12MM	1.75	18MM	35MM	25
CSM-12X40	12MM	1.75	18MM	40MM	25
CSM-12X50	12MM	1.75	18MM	50MM	10
CSM-12X55	12MM	1.75	18MM	55MM	10
CSM-12X60	12MM	1.75	18MM	60MM	10

HEX NUTS GRADE 8.8

PART#	SIZE (MM)	PITCH	STD PKG
HNM-4	4	.70	100
HNM-5	5	.80	100
HNM-6	6	1.00	100
HNM-8	8	1.25	100
HNM-10	10	1.50	25
HNM-12	12	1.75	25
HNM-14	14	2.00	25
HNM-16	16	2.00	25

HEX NUTS GRADE 10.9

PART#	SIZE (MM)	PITCH	STD PKG
HNM10-6	6	1.00	100
HNM10-8	8	1.25	100
HNM10-10	10	1.50	100
HNM10-12	12	1.75	100
HNM10-14	14	2.00	50



NYLON INSERT LOCK NUTS

PART#	SIZE (MM)	PITCH	STD PKG
NNM-5	5	.80	100
NNM-6	6	1.00	100
NNM-8	8	1.25	100
NNM-10	10	1.50	50



FLAT WASHERS



PART#	SCREW SIZE	I.D.	STD PKG
FWM-4	4MM	4.3	100
FWM-5	5MM	5.3	100
FWM-6	6MM	6.4	100
FWM-8	8MM	8.4	100
FWM-10	10MM	10.5	100
FWM-12	12MM	13.0	100

LOCK WASHERS



PART#	SCREW SIZE	I.D.	STD PKG
LWM-4	4MM	4.1	100
LWM-5	5MM	5.1	100
LWM-6	6MM	6.1	100
LWM-8	8MM	8.1	100
LWM-10	10MM	10.2	100
LWM-12	12MM	12.2	100
LWM-14	14MM	14.2	100
LWM-16	16MM	16.2	100

**Check out Page G16
for more information on
METRIC NUT & BOLT KITS**

PART# HB-40METRIC

1580 Piece assorted steel plated METRIC nuts, bolts and washers 6mm - 12mm. Includes the bin (HB-40) and labels. Bin Size: 33-3/4"W x 8-1/2"D x 22-1/4"H.

PART# HB10-80METRIC

2640 Piece assorted steel plated METRIC nuts, bolts and washers 6mm - 14mm. Includes 2 bins (HB-40) and labels. Bin Size: 33-3/4"W x 8-1/2"D x 22-1/4"H.

D8

PLATED HITCH PIN CLIPS

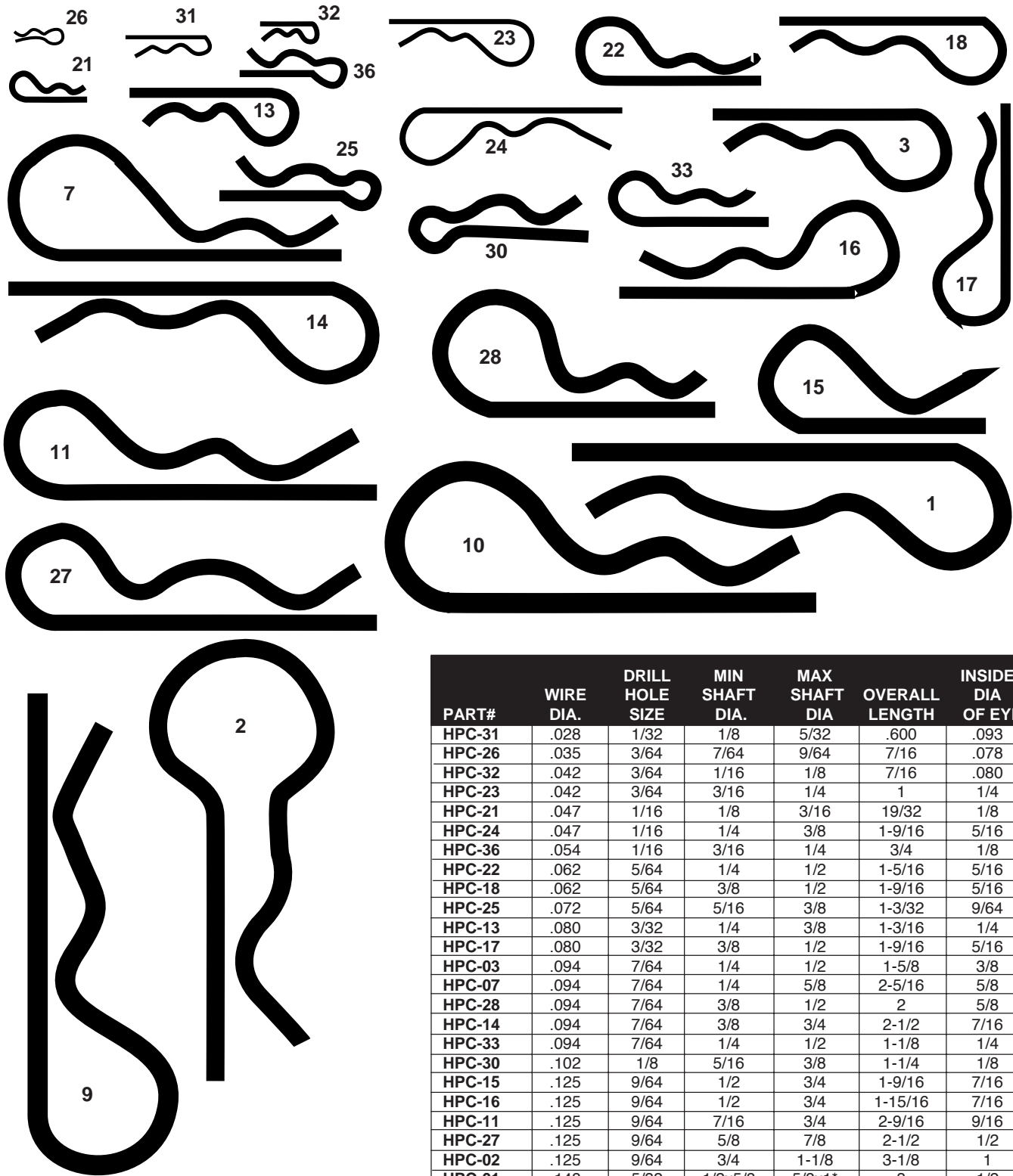

PART#	WIRE DIA.	DRILL HOLE SIZE	MIN SHAFT DIA.	MAX SHAFT DIA.	OVERALL LENGTH	INSIDE DIA OF EYE
HPC-31	.028	1/32	1/8	5/32	.600	.093
HPC-26	.035	3/64	7/64	9/64	7/16	.078
HPC-32	.042	3/64	1/16	1/8	7/16	.080
HPC-23	.042	3/64	3/16	1/4	1	1/4
HPC-21	.047	1/16	1/8	3/16	19/32	1/8
HPC-24	.047	1/16	1/4	3/8	1-9/16	5/16
HPC-36	.054	1/16	3/16	1/4	3/4	1/8
HPC-22	.062	5/64	1/4	1/2	1-5/16	5/16
HPC-18	.062	5/64	3/8	1/2	1-9/16	5/16
HPC-25	.072	5/64	5/16	3/8	1-3/32	9/64
HPC-13	.080	3/32	1/4	3/8	1-3/16	1/4
HPC-17	.080	3/32	3/8	1/2	1-9/16	5/16
HPC-03	.094	7/64	1/4	1/2	1-5/8	3/8
HPC-07	.094	7/64	1/4	5/8	2-5/16	5/8
HPC-28	.094	7/64	3/8	1/2	2	5/8
HPC-14	.094	7/64	3/8	3/4	2-1/2	7/16
HPC-33	.094	7/64	1/4	1/2	1-1/8	1/4
HPC-30	.102	1/8	5/16	3/8	1-1/4	1/8
HPC-15	.125	9/64	1/2	3/4	1-9/16	7/16
HPC-16	.125	9/64	1/2	3/4	1-15/16	7/16
HPC-11	.125	9/64	7/16	3/4	2-9/16	9/16
HPC-27	.125	9/64	5/8	7/8	2-1/2	1/2
HPC-02	.125	9/64	3/4	1-1/8	3-1/8	1
HPC-01	.148	5/32	1/2x5/8	5/8x1*	3	1/2
HPC-09	.148	5/32	3/4	1-1/8	3-5/16	3/4
HPC-10	.148	5/32	5/8	1	2-15/16	3/4

IMAGE SHOWS ACTUAL SIZE

* For Rectangular Shafts

Standard Package 100

PLATED HITCH PIN CLIPS

IMAGE SHOWS ACTUAL SIZE

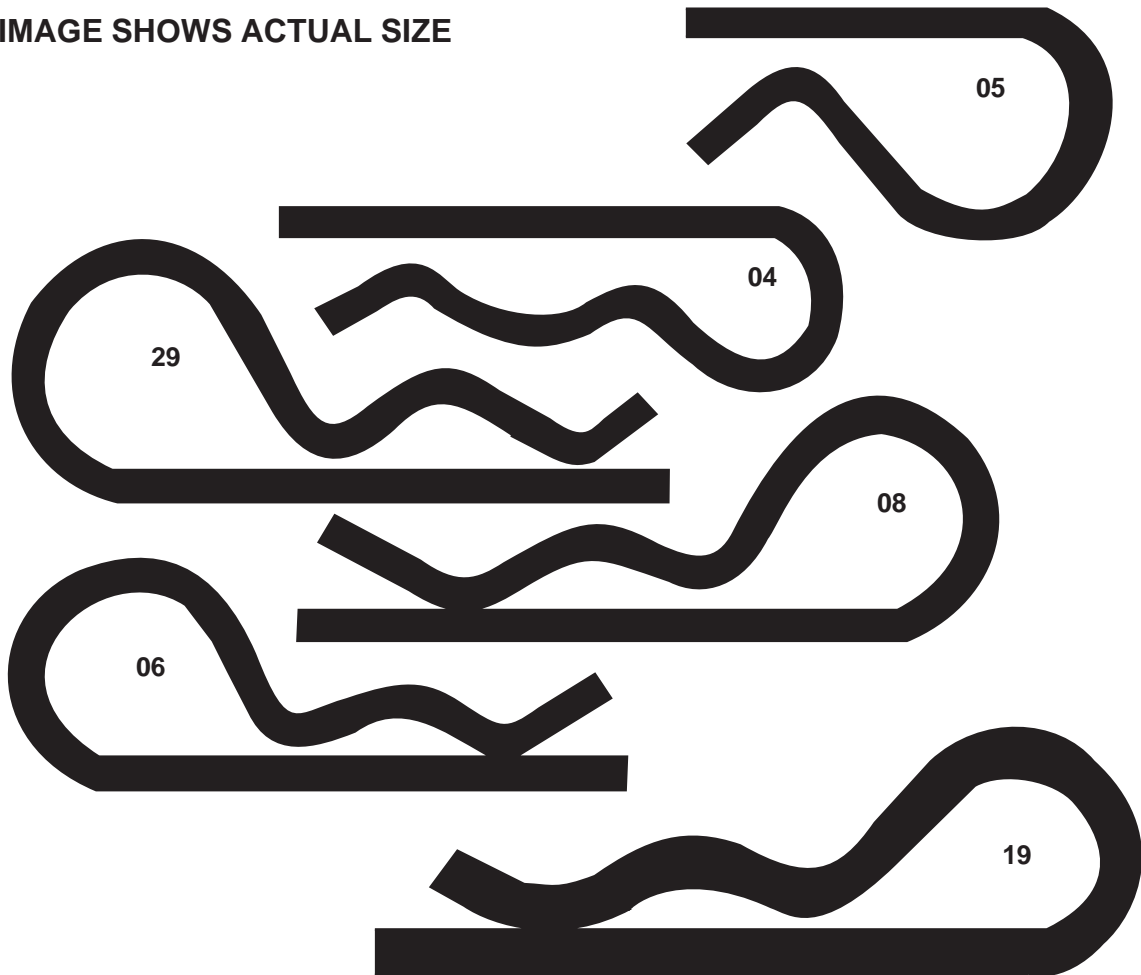

PART#	WIRE DIA.	DRILL HOLE SIZE	MIN SHAFT DIA.	MAX. SHAFT DIA.	OVERALL LENGTH	I.D. OF EYE	STD PKG
HPC-05	.162	3/16	7/8	1-1/16	2-3/16	7/8	50
HPC-04	.162	3/16	1/2X3/4	5/8X1*	3	5/8	50
HPC-29	.177	3/16	3/4	1-1/16	3-1/2	1	50
HPC-06	.177	3/16	5/8	1	3-1/4	7/8	50
HPC-08	.177	3/16	7/8	1-1/4	3-3/4	7/8	50
HPC-19	.243	17/64	3/4	1	4	3/4	25

* For Rectangular Shafts

POPULAR SIZES AVAILABLE IN STAINLESS STEEL

BENT ARM PINS



Handle and pin bent in a one-piece configuration. Here is a low cost pin available with a hole for applications requiring frequent removals. Standard 1018 carbon steel. Zinc plated. **Hitch Pin included.** Standard Package 10

PART#	USABLE LENGTH	DIA	HOLE DIA	HITCH CLASS	HITCH PIN
BAP-1/2X3	3"	.500	5/32	II	HPC-11
BAP-5/8X3	3"	.625	3/16	III	HPC-10

D10

PINS

STANDARD WIRE LOCKING PINS

Wire Locking Pins are like having a clevis pin and a cotter pin in one secure assembly. The wire loop is pulled over the pin end to lock it in place or remove it. This one-piece fastener eliminates cotter pin loss and fits most quick release applications. Made of a 1010 carbon steel cold-headed pin and spring wire loop, zinc plated. **Standard Package: 10**



ROUND

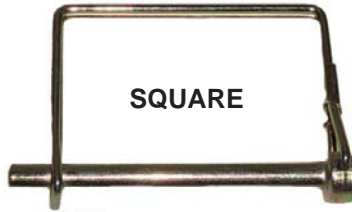

SQUARE

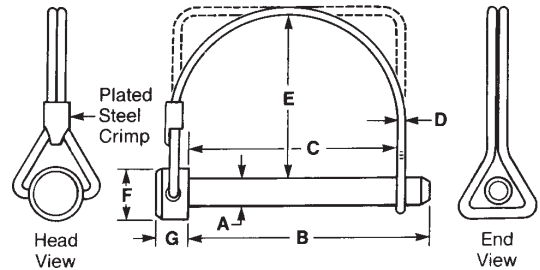

PART#	SIZE	A PIN DIAMETER	B PIN LENGTH	C EFFECTIVE LENGTH	D WIRE DIAMETER	E LOOP CLEARANCE	F HEAD DIAMETER	G HEAD HEIGHT	WIRE LOOP SHAPE
LP-142R	1/4" X 2"	.243-.248	2.000	1.750	.091	1.625	.562	.312	Round
LP-143S	1/4" X 3"	.243-.248	3.000	2.750	.091	1.750	.562	.312	Square
LP-516234R	5/16" X 2-3/4"	.306-.311	2.750	2.500	.091	2.000	.625	.312	Round
LP-516234S	5/16" X 2-3/4"	.306-.311	2.750	2.500	.091	1.750	.625	.312	Square
LP-38212S	3/8" X 2-1/2"	.368-.373	2.500	2.250	.091	1.500	.625	.312	Square

LYNCH PINS

Length measured from under the head to the end of the pin.



ITEM #	PIN DIA	PIN LENGTH	STD PKG
LYNP-316X1916	3/16"	1-9/16"	10
LYNP-516X134	5/16"	1-3/4"	10
LYNP-716X134	7/16"	1-3/4"	10

PLATED ROLL PINS (ZINC PLATED)



PART#	DIA.	LENGTH	WALL THICKNESS	STD PKG
RP-116X12	1/16"	1/2"	.012	100
RP-116X1	1/16"	1"	.012	100
RP-332X12	3/32"	1/2"	.022	100
RP-332X1	3/32"	1"	.022	100
RP-332X112	3/32"	1-1/2"	.022	100
RP-18X12	1/8"	1/2"	.028	100
RP-18X1	1/8"	1"	.028	100
RP-18X112	1/8"	1-1/2"	.028	100

PART#	DIA.	LENGTH	WALL THICKNESS	STD PKG
RP-532X34	5/32"	3/4"	.032	100
RP-532X12	5/32"	1/2"	.032	100
RP-532X1	5/32"	1"	.032	100
RP-532X112	5/32"	1-1/2"	.032	50
RP-532X2	5/32"	2"	.032	50
RP-316X34	3/16"	3/4"	.040	100
RP-316X1	3/16"	1"	.040	100
RP-316X112	3/16"	1-1/2"	.040	50
RP-316X2	3/16"	2"	.040	50
RP-14X34	1/4"	3/4"	.050	50
RP-14X1	1/4"	1"	.050	50
RP-14X112	1/4"	1-1/2"	.050	50
RP-14X2	1/4"	2"	.050	25
RP-14X212	1/4"	2-1/2"	.050	25

COTTER PINS (ZINC PLATED)

PART #	DIA	LENGTH	STD PKG
CP-116X12	1/16"	1/2"	100
CP-116X34	1/16"	3/4"	100
CP-116X1	1/16"	1"	100
CP-116X114	1/16"	1-1/4"	100
CP-116X112	1/16"	1-1/2"	100
CP-116X2	1/16"	2"	100
CP-332X1	3/32"	1"	100
CP-332X114	3/32"	1-1/4"	100
CP-332X112	3/32"	1-1/2"	100
CP-332X134	3/32"	1-3/4"	100
CP-332X2	3/32"	2"	100

PART #	DIA	LENGTH	STD PKG
CP-18X1	1/8"	1"	100
CP-18X114	1/8"	1-1/4"	100
CP-18X112	1/8"	1-1/2"	100
CP-18X134	1/8"	1-3/4"	100
CP-18X2	1/8"	2"	100
CP-18X212	1/8"	2-1/2"	100
CP-18X3	1/8"	3"	100
CP-532X1	5/32"	1"	100
CP-532X112	5/32"	1-1/2"	100
CP-532X134	5/32"	1-3/4"	100
CP-532X2	5/32"	2"	100



PART #	DIA	LENGTH	STD PKG
CP-316X1	3/16"	1"	100
CP-316X112	3/16"	1-1/2"	100
CP-316X134	3/16"	1-3/4"	100
CP-316X2	3/16"	2"	100
CP-316X212	3/16"	2-1/2"	100
CP-316X312	3/16"	3"	100

MACHINE SCREWS

D11

Machine Screws, are often used with nuts or driven into tapped holes. They are available in various head types and drive styles. Flat head fasteners are designed to fit flush to the surface when used with countersunk holes. Length is measured from the under side of the head. The Phillips drive style is designed so that the driver would slip out under extreme torque, preventing over-tightening and damage to the fastener or the material. Coarse threads are sturdier and are easier to thread and unthread compared to fine. TYPE "F" Machine Screw - cuts its own thread. See diagram below for how length is measured.



DIAMETER THREAD	LENGTH	STD PKG	PHILLIPS PAN HEAD	PHILLIPS FLAT HEAD	PHILLIPS TRUSS HEAD	TYPE "F" HEX WASHER HEAD
#6-32 COARSE	1/2"	100	MSCPX-612			
	3/4"	100	MSCPX-634			
	1"	100	MSCPX-61			
	1-1/2"	100	MSCPX-6112			
#8-32 COARSE	1/2"	100	MSCPX-812			
	3/4"	100	MSCPX-834			
	1"	100	MSCPX-81			
	1-1/2"	100	MSCPX-8112			
#10-32 FINE	1/2"	100	MSFPX-1012			
	3/4"	100	MSFPX-1034			
	1"	100	MSFPX-101			
	1-1/2"	100	MSFPX-10112			
#10-24 COARSE	1/2"	100	MSCPX-1012			
	5/8"	100	MSCPX-1058			
	3/4"	100	MSCPX-1034			
	1"	100	MSCPX-101			
	1-1/4"	100	MSCPX-10114			
	1-1/2"	100	MSCPX-10112			
1/4-20 COARSE	1/2"	100	MSCPX-1412	MSCFX-1412	MSCTX-1412	MSCHWF-1412
	3/4"	100	MSCPX-1434	MSCFX-1434	MSCTX-1434	MSCHWF-1434
	1"	100	MSCPX-141	MSCFX-141	MSCTX-141	MSCHWF-141
	1-1/4"	100		MSCFX-14114		
	1-1/2"	100	MSCPX-14112	MSCFX-14112		
	2"	100	MSCPX-142	MSCFX-142		
5/16-18 COARSE	1/2"	50				MSCHWF-51612
	3/4"	50				MSCHWF-51634
	1"	50				MSCHWF-5161
3/8-16 COARSE	1"	50				MSCHWF-381

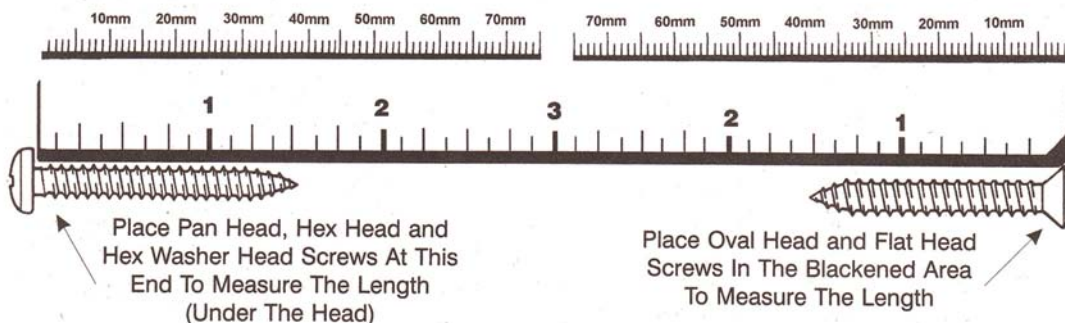

Toll Free: 800-922-6527 • Fax: 248-634-2022 • www.statewire.com

D12

SHEET METAL SCREWS

DIA	LENGTH	STD PKG	QUAD DRIVE			SQUARE DRIVE	
			PAN HEAD	PAN HEAD with /WASHER	FLAT HEAD	PAN HEAD	FLAT HEAD
#6	1/2"	100	SMSPQ-612				SMSFS-612
	3/4"	100	SMSPQ-634				
	1"	100				SMSPS-61	
	1-1/2"	100	SMSPQ-6112				
#8	3/8"	100	SMSPQ-838				
	1/2"	100	SMSPQ-812				SMSFS-812
	3/4"	100	SMSPQ-834	SMSPQW-812			SMSFS-834
	1"	100	SMSPQ-81	SMSPQW-81	SMSFQ-81		
	1-1/4"	100	SMSPQ-8114	SMSPQW-8114			SMSFS-8114
	1-1/2"	100	SMSPQ-8112	SMSPQW-8112	SMSFQ-8112		SMSFS-8112
	2"	100	SMSPQ-82	SMSPQW-82	SMSFQ-82		
	2-1/2"	100		SMSPQW-8212			SMSFS-8212
3"	100		SMSPQW-83			SMSFS-83	
#10	1/2"	100				SMSPS-1012	
	3/4"	100	SMSPQ-1034				
	1"	100	SMSPQ-101			SMSPS-10112	

QUAD DRIVE



SQUARE DRIVE



DIA	LENGTH	STD PKG	QUAD DRIVE		SQUARE
			BRONZE w/WASHER PAN HEAD	WHITE PAN HEAD	BLACK PAN HEAD
#8	3/4"	100	SMSPQWBRZ-834	SMSPQWHT-834	
	1"	100	SMSPQWBRZ-81	SMSPQWHT-81	SMSPSBLK-81
	1-1/4"	100	SMSPQWBRZ-8114		
	1-1/2"	100	SMSPQWBRZ-8112	SMSPQWHT-8112	SMSPSBLK-8112
	2"	100	SMSPQWBRZ-82		
	2-1/2"	100	SMSPQWBRZ-8212		

PAN HEAD



DIA	LENGTH	STD PKG	HEX HEAD		PHILLIPS		
			HEX WASHER SLOTTED	HEX WASHER	PAN HEAD	BLACK OXIDE PAN HEAD	ROUNDHEAD WASHER BLACK
#8	1/2"	100	SMSHWI-812		SMSPX-812	SMSPXB-812	SMSRXWB-812
	5/8"	100			SMSPX-858		SMSRXWB-858
	3/4"	100	SMSHWI-834	SMSHW-834	SMSPX-834	SMSPXB-834	SMSRXWB-834
	1"	100		SMSHW-81	SMSPX-81	SMSPXB-81	SMSRXWB-81
	1-1/4"	100	SMSHWI-8114				
	1-1/2"	100	SMSHWI-8112		SMSPX-8112		SMSRXWB-8112
#10	1/2"	100	SMSHWI-1012	SMSHW-1012	SMSPX-1012	SMSPXB-1012	
	5/8"	100		SMSHW-1058	SMSPX-1058		
	3/4"	100	SMSHWI-1034		SMSPX-1034	SMSPXB-1034	
	1"	100	SMSHWI-101	SMSHW-101	SMSPX-101	SMSPXB-101	
	1-1/4"	100			SMSPX-10114		
	1-1/2"	100	SMSHWI-10112		SMSPX-10112		
#12	1/2"	100			SMSPX-102		
	3/4"	100			SMSPX-1212		
	1"	100			SMSPX-1234		
	1-1/4"	100			SMSPX-121		
	1-1/2"	100			SMSPX-12114		
	2"	100			SMSPX-12112		
1/4"	1/2"	100	SMSHWI-1412		SMSPX-1412		
	3/4"	100	SMSHWI-1434	SMSHW-1434	SMSPX-1434		
	1"	100	SMSHWI-141	SMSHW-141	SMSPX-141		
	1-1/4"	100		SMSHW-14114			
	1-1/2"	100	SMSHWI-14112	SMSHW-14112	SMSPX-14112		
	2"	100	SMSHWI-142		SMSPX-142		
5/16"	1/2"	100	SMSHWI-51612				
	3/4"	100	SMSHWI-51634				
	1"	50	SMSHWI-5161				
	1-1/4"	50	SMSHWI-516114				
	1-1/2"	50	SMSHWI-516112				

HEX HEAD



PHILLIPS



TEK AND DRYWALL SCREWS D13

Tek Screws can be used in place of welding, riveting, using nuts and bolts, drilling and tapping holes, or using adhesives. Easy to use, self-drilling, self-tapping. Perform jobs in one fast, simple operation. Plywood, softwoods, composition board, laminates to metal. Metal to metal where total grip does not exceed drill point length. Metal to metal where total grip exceeds drill point length but pre-drilled or pre-punched hole exists in material to be fastened. **Standard Package 100.**

—ZINC—



DIA	LENGTH	HEX HEAD W / WASHER	PAN PHILLIPS HEAD	ROUND PHILLIPS W / WASHER	PAN HEAD QUAD DRIVE
#6	3/8"	TS-638	TS-PX638		
	1/2"	TS-612	TS-PX612		
	3/4"	TS-634	TS-PX634		
1/4" Head	1"		TS-PX61		
#8	1/2"	TS-812	TS-PX812	TS-RXW812	TS-PSQ812
	3/4"	TS-834	TS-PX834	TS-RXW834	TS-PSQ834
	1"	TS-81	TS-PX81	TS-RXW81	TS-PSQ81
1/4" Head	1-1/4"	TS-8114			
	1-1/2"	TS-8112	TS-PX8112		TS-PSQ8112
#10	1/2"	TS-1012	TS-PX1012		
	3/4"	TS-1034	TS-PX1034		
	1"	TS-101	TS-PX101		
5/16" Head	1-1/4"	TS-10114			
	1-1/2"	TS-10112	TS-PX10112		
2"		TS-102			
#12	3/4"	TS-1234			
	1"	TS-121			
	1-1/2"	TS-12112			
5/16" Head	2"	TS-122			
1/4"	3/4"	TS-1434			
	1"	TS-141			
	1-1/4"	TS-14114			
3/8" Head	1-1/2"	TS-14112			
	2"	TS-142			
	3"	TS-143*			

* - Std Pkg: 50

—BLACK—



DIA	LENGTH	HEX HEAD W / WASHER	PAN PHILLIPS HEAD	OVAL PHILLIPS W/BEAUTY WASHER	ROUND PHILLIPS W/WASHER
#8	1/2"	TSB-812	TSB-PX812		TSB-RXW812
	3/4"	TSB-834	TSB-PX834	TSB-BWX834	TSB-RXW834
	1"	TSB-81	TSB-PX81	TSB-BWX81	TSB-RXW81
	1-1/4"	TSB-8114			
	1-1/2"	TSB-8112	TSB-PX8112		
#10	1/2"	TSB-1012			
	3/4"	TSB-1034			
	1"	TSB-101			
1/4"	1"	TSB-141			
	1-1/2"	TSB-14112			

TRUSS / OCTAGON TEK SCREWS



PART# TS-TOC101

#10 Diameter Thread. 1" Length. Looks like a torque drive but really a **SQUARE DRIVE**. Additional sizes available upon request. **Standard Package 100**

FLOORING TEK SCREWS (WITH EARS)



PART #	SIZE	STD PKG
TS-FX12212E	12-24 x 2-1/2	100
TS-FX14234E	1/4-20 x 2-3/4	50

Flat Head #3 Phillips Drive Flooring Tek Screw. Tek point drills its own hole. Two ears bore through wood flooring and break off when they make contact with metal frame. Thread cutting notch in the side of the screw will cut thread in steel up to 3/8" thick. Zinc plated to resist rust.

DRY WALL SCREWS

An outstanding screw available for attaching drywall to metal studs from 25 gauge through 20 gauge or plywood to sheet metal. Black phosphate finish. **Phillips Bugle Head.**



PART#	COARSE THREAD		
	DIA	LENGTH	STD PKG
DWS-1	6	1	100
DWS-114	6	1-1/4	100
DWS-158	6	1-5/8	100
DWS-2	6	2	100
DWS-212	8	2-1/2	100
DWS-3	8	3	100
FINE THREAD			
DWS-F1	6	1	100
DWS-F2	6	2	100
DWS-F212	8	2-1/2	100
DWS-F3	8	3	100

THREADED ROD

Zinc Plated. Grade 2 Coarse thread. **36 inches.** Tensile Strength: 65,000 PSI.

PART#	DIA	
	THREAD	STD PKG
THRC-1/4	1/4-20	5
THRC-5/16	5/16-18	5
THRC-3/8	3/8-16	5
THRC-1/2	1/2-13	3

D14 18-8 STAINLESS STEEL FASTENERS

CAP SCREWS

—COARSE THREAD—



PART#	SIZE	STD PKG
CSCS1412	1/4-20 x 1/2"	50
CSCS1434	1/4-20 x 3/4"	50
CSCS141	1/4-20 x 1"	50
CSCS14114	1/4-20 x 1-1/4"	50
CSCS14112	1/4-20 x 1-1/2"	50
CSCS14134	1/4-20 x 1-3/4"	25
CSCS142	1/4-20 x 2"	25
CSCS14212	1/4-20 x 2-1/2"	25
CSCS143	1/4-20 x 3"	25
CSCS51634	5/16-18 x 3/4"	25
CSCS5161	5/16-18 x 1"	25
CSCS516114	5/16-18 x 1-1/4"	25
CSCS516112	5/16-18 x 1-1/2"	25
CSCS5162	5/16-18 x 2"	25
CSCS516212	5/16-18 x 2-1/2"	25
CSCS5163	5/16-18 x 3"	25
CSCS381	3/8-16 x 1"	50
CSCS38114	3/8-16 x 1-1/4"	25
CSCS38112	3/8-16 x 1-1/2"	25
CSCS382	3/8-16 x 2"	25
CSCS38212	3/8-16 x 2-1/2"	25

COTTER PINS

—EXTENDED PRONG TYPE—



PART#	SIZE	REC. HOLE SIZE	STD PKG
CPS11634	1/16" x 3/4"	.078	100
CPS1161	1/16" x 1"	.078	100
CPS3321	3/32" x 1"	.109	100
CPS332114	3/32" x 1-1/4"	.109	100
CPS332112	3/32" x 1-1/2"	.109	100
CPS181	1/8" x 1"	.141	100
CPS18112	1/8" x 1-1/2"	.141	100
CPS182	1/8" x 2"	.141	100

FENDER WASHERS



PART#	SIZE (ID)	SIZE (OD)	STD PKG
FNWS101	No. 10	1"	100
FNWS141	1/4"	1"	100
FNWS14114	1/4"	1-1/4"	100
FNWS516112	5/16"	1-1/2"	100
FNWS38112	3/8"	1-1/2"	100

COMMERCIAL FLAT WASHERS



PART#	SIZE	I.D. (A)	O.D. (B)	APPROXIMATE THICKNESS(C)	STD PKG
FWS6	No. 6	5-32"	3/8"	.030	100
FWS8	No. 8	3/16"	7/16"	.030	100
FWS10	No.10	7/32"	1/2"	.030	100
FWS12	No.12	1/4"	39/64"	.043	100
FWS1/4	1/4"	5/16"	47/64"	.043	100
FWS5/16	5/16"	3/8"	7/8"	.050	100
FWS3/8	3/8"	7/16"	1"	.060	100
FWS7/16	7/16"	1/2"	1-1/4"	.060	50
FWS1/2	1/2"	9/16"	1-3/8"	.060	50
FWS5/8	5/8"	11/16"	1-3/4"	.075	100

MEDIUM SPLIT LOCKWASHERS

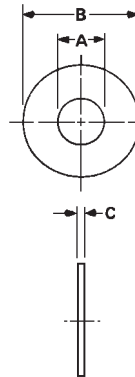

PART#	SIZE	STD PKG
LWS6	No. 6	100
LWS8	No. 8	100
LWS10	No.10	100
LWS1/4	1/4"	100
LWS5/16	5/16"	100
LWS3/8	3/8"	100
LWS1/2	1/2"	100

HEX MACHINE SCREW NUTS



PART#	SIZE	APPROX HEX WIDTH	STD PKG
MNCS6	6-32	5/16"	100
MNCS8	8-32	11/32"	100
MNCS10	10-24	3/8"	100
MNFS10	10-32	3/8"	100
MNCS1/4	1/4-20	7/16"	100

HEX NUTS



PART#	SIZE	STD PKG
HNCS1/4	1/4-20	100
HNCS5/16	5/16-18	50
HNCS3/8	3/8-16	50
HNCS1/2	1/2-13	25

NYLON INSERT LOCK NUTS



PART#	SIZE	STD PKG
NNCS6	6-32	50
NNCS8	8-32	50
NNCS10	10-24	50
NNFS10	10-32	50
NNCS1/4	1/4-20	50
NNFS1/4	1/4-28	50
NNCS5/16	5/16-18	50
NNFS5/16	5/16-24	100
NNCS3/8	3/8-16	25
NNFS3/8	3/8-24	25
NNCS7/16	7/16-14	25
NNCS1/2	1/2-13	10
NNFS1/2	1/2-20	25

18-8 STAINLESS STEEL SCREWS

D15

MACHINE SCREWS



**PAN HEAD
PHILLIPS**



**OVAL HEAD
PHILLIPS**



**FLAT HEAD
PHILLIPS**

DIAMETER THREAD	LENGTH	STD PKG	PAN HEAD PHILLIPS	OVAL HEAD PHILLIPS	FLAT HEAD PHILLIPS
#6-32 COARSE	1/2"	100	MSCPXS612		
	3/4"	100	MSCPXS634		
	1"	100	MSCPXS61		
	1-1/2"	100	MSCPXS6112		
	2"	100	MSCPXS62		
#8-32 COARSE	1/2"	100	MSCPXS812	MSCOXS812	
	3/4"	100	MSCPXS834	MSCOXS834	
	1"	100	MSCPXS81	MSCOXS81	
	1-1/2"	100	MSCPXS8112		
	2"	100	MSCPXS82		
#10-32 FINE	1/2"	100	MSFPXS1012		
	3/4"	100	MSFPXS1034		
	1"	100	MSFPXS101		
	1-1/2"	100	MSFPXS10112		
	2"	100	MSFPXS102		
#10-24 COARSE	1/2"	100	MSCPXS1012	MSCOXS1012	
	3/4"	100	MSCPXS1034	MSCOXS1034	
	1"	100	MSCPXS101	MSCOXS101	
	1-1/2"	100	MSCPXS10112	MSCOXS10112	
	2"	100	MSCPXS102	MSCOXS102	
1/4-20 COARSE	2-1/2"	50	MSCPXS10212	MSCOXS10212	
	3"	50	MSCPXS103	MSCOXS103	
	1/2"	50	MSCPXS1412		
	3/4"	50	MSCPXS1434	MSCOXS1434	MSCFXS1434
	1"	50	MSCPXS141	MSCOXS141	MSCFXS141
	1-1/4"	50	MSCPXS14114	MSCOXS14114	
	1-1/2"	50	MSCPXS14112	MSCOXS14112	MSCFXS14112
	1-3/4"	50			MSCFXS14134
	2"	50	MSCPXS142	MSCOXS142	MSCFXS142
2-1/2"	25	MSCPXS14212	MSCOXS14212	MSCFXS14212	
3"	25	MSCPXS143	MSCOXS143		
4"	25	MSCPXS144	MSCOXS144		

SHEET METAL SCREWS



**PAN HEAD
PHILLIPS**



**OVAL HEAD
PHILLIPS**



**FLAT HEAD
PHILLIPS**

DIAMETER THREAD	LENGTH	STD PKG	PAN HEAD PHILLIPS	OVAL HEAD PHILLIPS	FLAT HEAD PHILLIPS
#6	1/2"	100	SMSPXS612	SMSOXS612	
	5/8"	100	SMSPXS658		
	3/4"	100	SMSPXS634	SMSOXS634	SMSFXS634
	1"	100	SMSPXS61	SMSOXS61	SMSFXS61
	1-1/4"	100	SMSPXS6114		
	1-1/2"	100	SMSPXS6112	SMSOXS6112	
#8	1/2"	100	SMSPXS812	SMSOXS812	SMSFXS812
	5/8"	100	SMSPXS858		
	3/4"	100	SMSPXS834	SMSOXS834	SMSFXS834
	1"	100	SMSPXS81	SMSOXS81	SMSFXS81
	1-1/4"	100	SMSPXS8114	SMSOXS8114	SMSFXS8114
	1-1/2"	100	SMSPXS8112	SMSOXS8112	SMSFXS8112
#10	2"	100	SMSPXS82	SMSOXS82	
	1/2"	100	SMSPXS1012	SMSOXS1012	
	3/4"	100	SMSPXS1034	SMSOXS1034	SMSFXS1034
	1"	100	SMSPXS101	SMSOXS101	SMSFXS101
	1-1/4"	100	SMSPXS10114	SMSOXS10114	SMSFXS10114
	1-1/2"	100	SMSPXS10112	SMSOXS10112	SMSFXS10112
#12	2"	100	SMSPXS102	SMSOXS102	
	2-1/2"	50	SMSPXS10212		
	3"	50	SMSPXS103		
	1/2"	100	SMSPXS1212		
	3/4"	100	SMSPXS1234		
#14	1"	100	SMSPXS121	SMSOXS121	
	1-1/4"	100		SMSOXS12114	
	1-1/2"	50	SMSPXS12112	SMSOXS12112	
	2"	50	SMSPXS122	SMSOXS122	
	3/4"	100	SMSPXS1434		
#14	1"	100	SMSPXS141	SMSOXS141	SMSFXS141
	1-1/4"	50	SMSPXS14114		
	1-1/2"	50	SMSPXS14112	SMSOXS14112	SMSFXS14112
	2"	50	SMSPXS142	SMSOXS142	
	2-1/2"	50	SMSPXS14212	SMSOXS14212	
3"	50		SMSOXS143		

D16

BLIND RIVETS

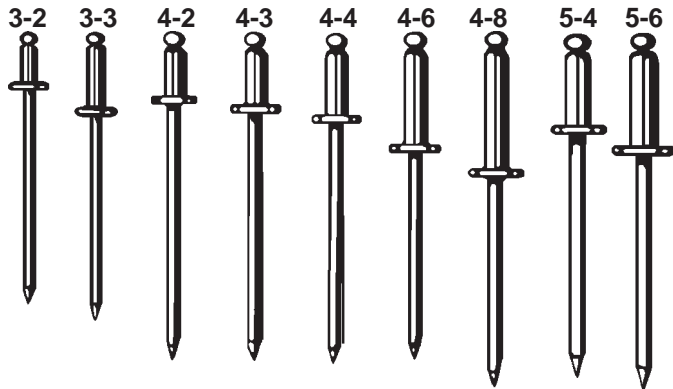

ORDERING EXAMPLE
BR 4 - 2 S S D

**ACTUAL
 SIZE**

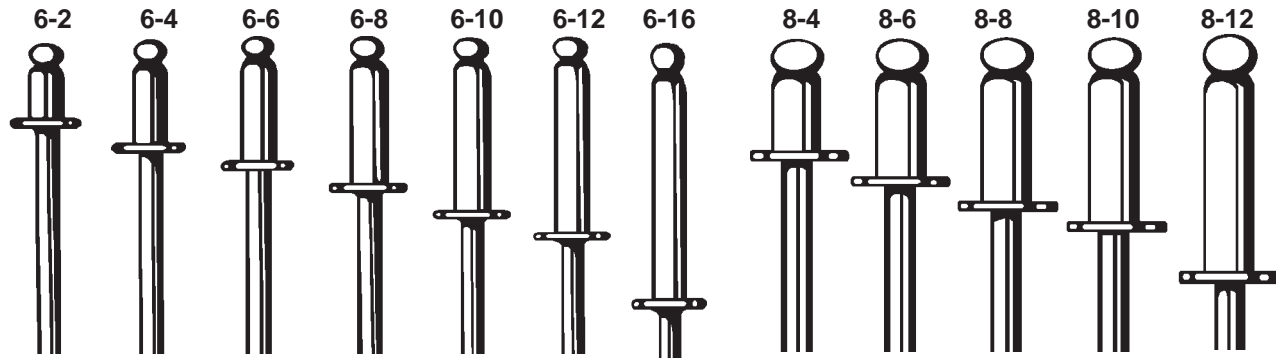
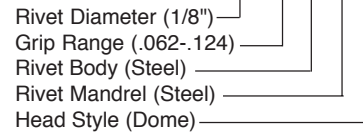

RIVET DIMETER	PANEL WIDTH UP TO	GRIP RANGE	BODY LENGTH EXCLUDING FLANGE	ALL ALUMINUM PART#	ALL STEEL PART#	ALUMINUM STEEL PART#	STAINLESS STEEL PART#
3/32"	1/8"	.065 - .125	15/64"	BR3-2AAD	BR3-2SSD		
3/32"	1/4"	.125 - .250	3/8"	BR3-4AAD	BR3-4SSD		
1/8"	1/8"	.065 - .125	7/32"	BR4-2AAD		BR4-2ASD ¹	
1/8"	3/16"	.097 - .187	9/32"	BR4-3AAD			
1/8"	1/4"	.125 - .250	3/8"	BR4-4AAD	BR4-4SSD	BR4-4ASD ¹	BR4-4STD
1/8"	3/8"	.313 - .375	1/2"	BR4-6AAD	BR4-6SSD	BR4-6ASD ¹	BR4-6STD
1/8"	1/2"	.375 - .500	5/8"	BR4-8AAD		BR4-8ASD ¹	
1/8"	5/8"	.500 - .625	13/16"	BR4-10AAD			
5/32"	1/4"	.125 - .250	3/8"	BR5-4AAD			
5/32"	3/8"	.250 - .375	1/2"	BR5-6AAD			
5/32"	1/2"	.375 - .500	5/8"	BR5-8AAD			
5/32"	5/8"	.500 - .625	13/16"	BR5-10AAD			
3/16"	1/8"	.065 - .125	15/64"	BR6-2AAD	BR6-2SSD		
3/16"	1/4"	.125 - .250	3/8"	BR6-4AAD	BR6-4SSD	BR6-4ASD ¹	BR6-4STD
3/16"	3/8"	.250 - .375	1/2"	BR6-6AAD		BR6-6ASD ¹	BR6-6STD
3/16"	1/2"	.375 - .500	5/8"	BR6-8AAD		BR6-8ASD ¹	
3/16"	5/8"	.500 - .625	13/16"	BR6-10AAD	BR6-10SSD		BR6-10STD
3/16"	3/4"	.625 - .750	7/8"	BR6-12AAD			
3/16"	1"	.751 - 1.00	1-3/16"	BR6-16AAD			
1/4"	1/4"	.125 - .250	3/8"	BR8-4AAD		BR8-4ASD ¹	
1/4"	3/8"	.250 - .375	1/2"	BR8-6AAD			
1/4"	1/2"	.375 - .500	5/8"	BR8-8AAD			
1/4"	5/8"	.500 - .625	13/16"	BR8-10AAD		BR8-10ASD ¹	
1/4"	3/4"	.625 - .750	7/8"	BR8-12AAD			

Standard Package 100. Additional sizes available upon request.

¹Aluminum Body, Steel Mandrel.

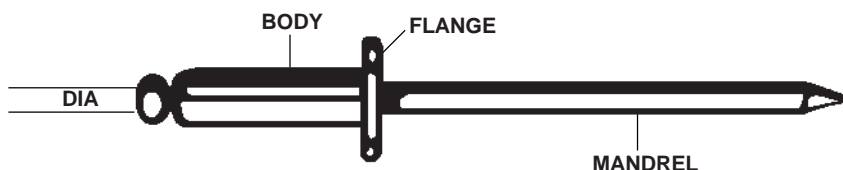

State Wire and Terminal, Inc.

BLIND RIVETS AND THREAD SERTS D17

BLIND RIVETS WITH LARGE FLANGE DOME HEAD are used for fastening soft materials such as wood, plastic, leather or fabric, for a greater distribution of head-bearing load. **Standard Package 100**

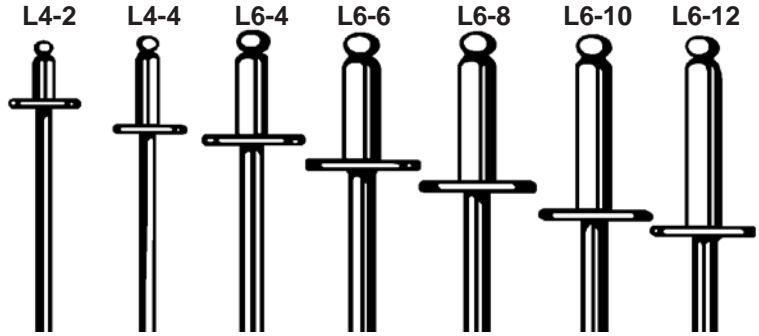

ACTUAL SIZE

BLIND RIVET BACK-UP WASHERS



ALUMINUM PART#	FOR RIVET DIAMETER
BRBUW-4A	1/8"
BRBUW-6A	3/16"

Standard Package 100

RIVET DIAMETER	PANEL WIDTH	GRIP RANGE	BODY LENGTH EXCLUDING FLANGE	ALL ALUMINUM PART#	ALL STEEL PART#	ALUMINUM STEEL PART#
1/8"	1/8"	.065 - .125	15/16"	BR4-2AADL		
1/8"	1/4"	.125 - .250	3/8"	BR4-4AADL	BR4-4SSDL	
3/16"	1/4"	.125 - .250	3/8"	BR6-4AADL	BR6-4SSDL	BR6-4ASDL ¹
3/16"	3/8"	.250 - .375	1/2"	BR6-6AADL	BR6-6SSDL	BR6-6ASDL ¹
3/16"	1/2"	.375 - .500	5/8"	BR6-8AADL	BR6-8SSDL	BR6-8ASDL ¹
3/16"	5/8"	.500 - .625	13/16"	BR6-10AADL		
3/16"	3/4"	.625 - .725	7/8"	BR6-12AADL	BR6-12SSDL	

¹Aluminum Body, Steel Mandrel.

ALUMINUM THREAD-SERT KIT



PART# BR-39213

This Aluminum Thread-Sert Kit contains the BR-39300 thread-setter tool in a molded plastic case with 6-32, 8-32, 10-24, 10-32, 1/4-20, 5/16-18 and 3/8-16 mandrels and nosepieces, wrench and instructions. The Kit contains 62 assorted Aluminum thread serts.

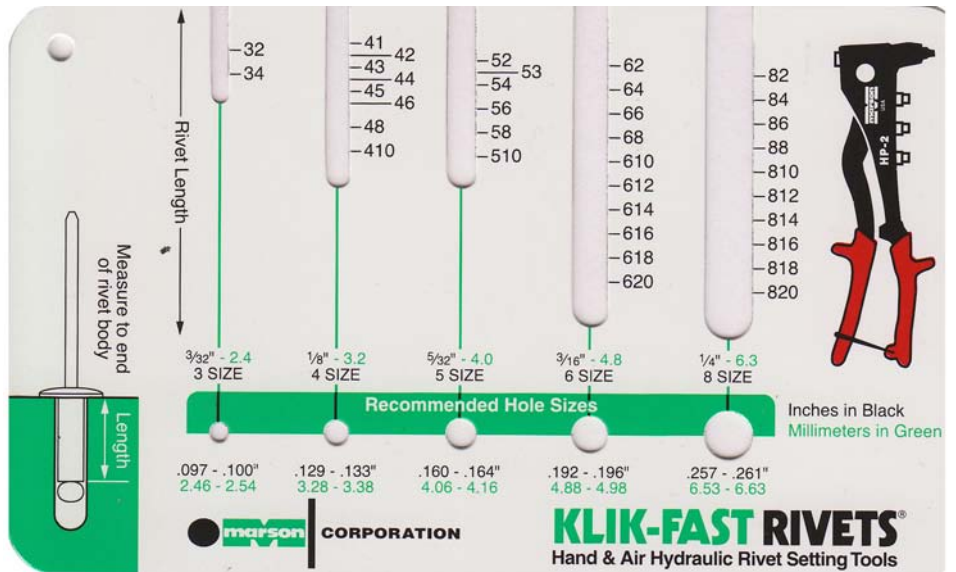

THREAD-SETTER™ TOOL

PART# BR-39300

This quality threaded insert installation tool features patented bearing design, comfortable hand grips and a locking chain. Comes with mandrels for sizes 8-32, 10-24 and 10-32. Handles 6-32 thru 3/8 aluminum and 6-32 thru 1/4 steel rivet nuts.

Not for use with 5/16, 3/8, or 8MM **STEEL** rivet nuts / threadserts



HAND RIVET GUN









PART# BR-HP2

Precision die cast, high strength aluminum alloy body; drop forged carbon steel upper handle; and thick cushion-molded vinyl grips for comfort. The BR-HP2 sets up to 3/16" steel rivets and comes with four mounted nosepieces (3/32", 1/8", 5/32", and 3/16") and a service wrench. Weight 1 lb. 3 oz. Not for 1/4" Rivets.



D18 GREASE FITTINGS AND GROMMETS

GREASE FITTINGS

<p>C-0641</p>  <p>1/4-28 Taper Thread Fitting Short Ball Check 17/32" Overall Standard Package 100</p>	<p>C-0698</p>  <p>1/4-28 Taper Thread Fitting Extra Long Ball Check 1-1/16" Overall Standard Package 100</p>	<p>C-0637</p>  <p>1/4-28 Taper Thread Fitting 45 Degree Angle, Short Ball Check 7/8" Overall Standard Package 100</p>	<p>C-0638</p>  <p>1/4-28 Taper Thread Fitting 90 Degree Angle, Short Ball Check 47/64" Overall Standard Package 100</p>	
<p>C-0610</p>  <p>1/8 Pipe Thread Fitting Ball Check 11/16" Overall Standard Package 100</p>	<p>C-0667</p>  <p>1/8 Pipe Thread Fitting Extra Long Ball Check 1-1/4" Overall Standard Package 25</p>	<p>C-0688</p>  <p>1/8 Pipe Thread Fitting 45 Degree Angle Ball Check 1" Overall Standard Package 50</p>	<p>C-0613</p>  <p>1/8 Pipe Thread Fitting 90 Degree Angle Ball Check 13/16" Overall Standard Package 50</p>	<p>C-3610</p>  <p>8mm X 1.0 Straight Standard Package 25</p>

ACTUAL SIZE OF 1/4-28 BOLT THREAD —  — ACTUAL SIZE OF 1/8 PIPE THREAD

PLASTIC GROMMETS



Black plastic grommets snap in place and resist up to 35 pounds pull. Eliminate sharp edges and protect wires and harnesses through holes.

PART #	INSIDE DIAMETER	MOUNTING HOLE	OVERALL HEIGHT	STD PKG
PG-1/8	1/8"	1/4"	5/16"	100
PG-1/4	1/4"	3/8"	13/32"	100
PG-3/8	3/8"	1/2"	13/32"	100
PG-1/2	1/2"	5/8"	13/32"	100
PG-5/8	5/8"	3/4"	13/32"	50
PG-11/16	11/16"	7/8"	29/64"	50
PG-3/4	3/4"	1"	29/64"	50
PG-1-3/8	1-3/8"	1-3/4"	29/64"	50

RUBBER GROMMETS

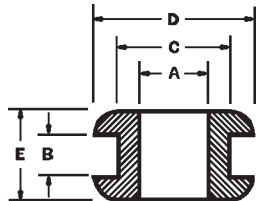

Standard Package 25

PART #	(A) BORE DIAMETER	(B) GROOVE THICKNESS	(C) GROOVE DIAMETER	(D) OUTSIDE DIAMETER	(E) OVERALL THICKNESS
RG18332	1/8"	3/32"	3/8"	1/2"	5/16"
RG532116	5/32"	1/16"	1/4"	3/8"	3/16"
RG532332	5/32"	3/32"	1/4"	7/16"	3/8"
RG316116	3/16"	1/16"	5/16"	1/2"	1/4"
RG316332	3/16"	3/32"	9/32"	7/16"	7/32"
RG31614	3/16"	1/4"	5/16"	7/16"	3/8"
RG141116	1/4"	1/16"	7/16"	5/8"	3/16"
RG141161	1/4"	1/16"	1"	1-1/4"	1/4"
RG516116	5/16"	1/16"	7/16"	9/16"	3/16"
RG51618	5/16"	1/8"	9/16"	13/16"	3/8"
RG51614	5/16"	1/4"	9/16"	13/16"	1/2"
RG381116	3/8"	1/16"	1/2"	11/16"	9/32"
RG381161	3/8"	1/16"	1"	1-1/4"	1/4"
RG3814	3/8"	1/4"	5/8"	7/8"	1/2"
RG12332	1/2"	3/32"	3/4"	31/32"	9/32"
RG1218	1/2"	1/8"	3/4"	1"	1/2"
RG1214	1/2"	1/4"	13/16"	1-1/16"	1/2"
RG5818	5/8"	1/8"	7/8"	1-1/8"	3/8"
RG58116	5/8"	1/16"	7/8"	1-1/8"	5/16"
RG34116	3/4"	1/16"	15/16"	1-1/8"	1/4"
RG34116114	3/4"	1/16"	1-1/4"	1-5/8"	1/4"
RG3414	3/4"	1/4"	1-1/4"	1-5/8"	7/16"

State Wire and Terminal, Inc.

QUICK INDEX SECTION E

E1

Switches / Replacement Keys / Truck & Trailer Products / Back-Up Alarms

E2-3 Toggle Switches and Accessories

E5 Rocker and Push-Pull Switches

E6 Momentary Switches, Master Disconnect and Precision Ball Switches, Accessories

E7-8 Marine Starter and Ignition Starter Switches

E9 Replacement Keys, Solenoid Switches

E10 Junction Boxes, Terminal Blocks, Valves

E11 Electronic Brake Controls, 5704 Series Pendant Trailer Harness, Molded Trailer Connectors Electronic Taillight Converter and Coiled Cable Assembly without ends.

E12 Trailer Adapters, 7-Way RV Oem Style Kit and Socket, Accessories

E13 7-Way Blade Connectors, Heavy Duty Trucking Plugs, Sockets and Accessories

E14 6-Way and 4-Way Metal Connectors and Plugs, Sockets and Accessories

E15 Tarping 2-Pole Power Take Off Connectors, Single Pole Metal Connectors, Plugs and Sockets, Electrical Terms

E16 Back-Up Alarms

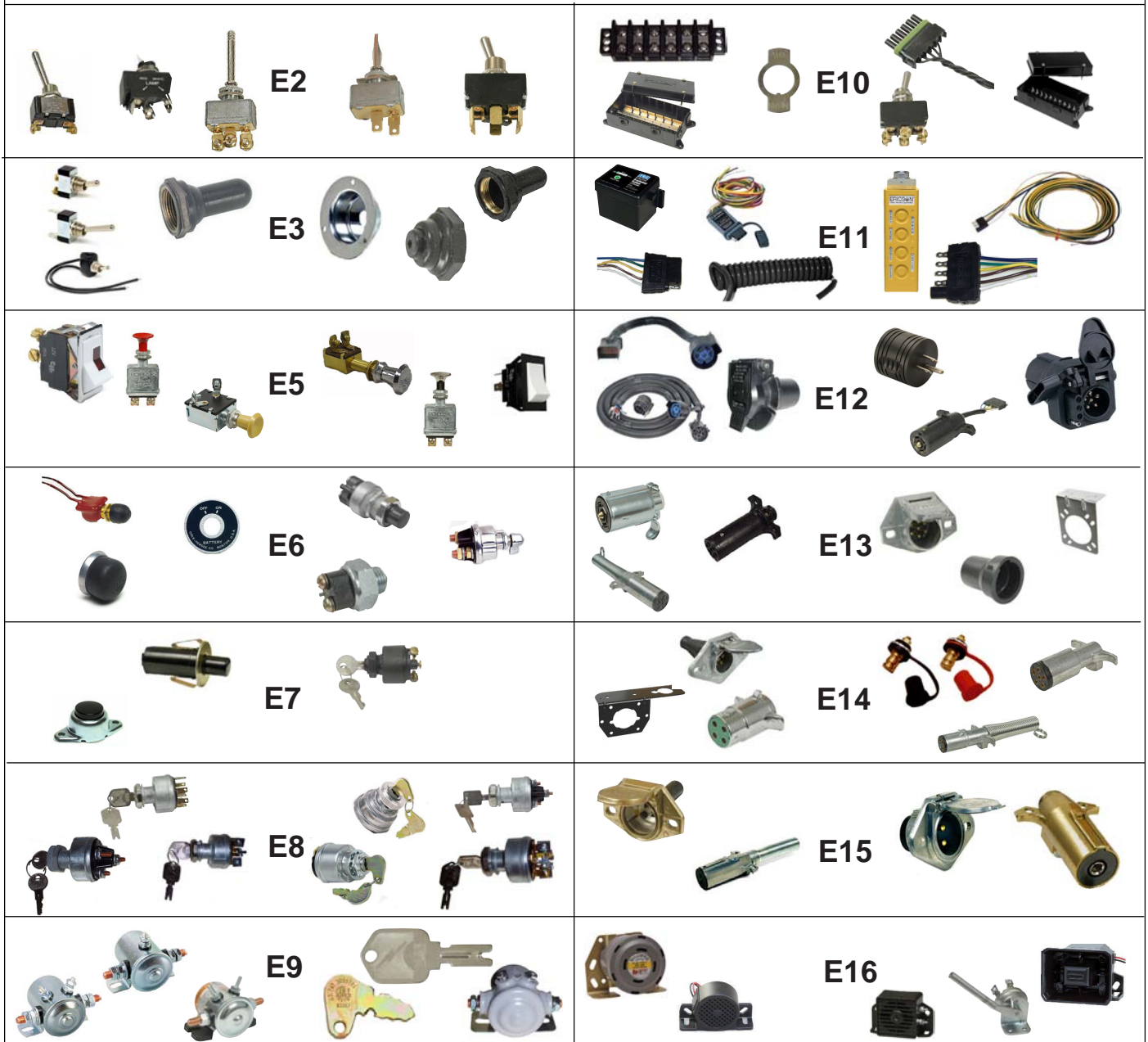



Long Handle
#6-32 Screw Terminals



Jumper Style
.250 Blade Terminals



Nylon Handle Decorator Style
.250 Blade Terminals

Pictures are shown as a reference and may differ in appearance from the parts listed.

Medium Duty. 20Amps @ 12 VDC. A complete selection of circuitry configurations for Heavy Duty Truck, Off-Road, Automotive and Recreational Vehicle applications. Provides durable and long lasting solutions to new and replacement requirements.

PART#	CIRCUITRY	# OF TERMINALS	TERMINAL TYPE	HANDLE TYPE	HANDLE LENGTH	HANDLE FINISH	OTHER DESCRIPTION
S.P.S.T. (SINGLE POLE - SINGLE THROW)							
P-34-571	On-Off	2	Screw	Standard	11/16"	Chrome	
P-34-571Q ¹	On-Off	2	Blade	Standard	11/16"	Chrome	
P-34-571L ²	On-Off	2	Screw	Long	1-1/2"	Chrome	
P-34-586Q ¹	On-Off	4	Blade	Standard	11/16"	Lighted	Transparent Lexan Handle ³
S.P.D.T. (SINGLE POLE - DOUBLE THROW)							
P-34-572	On-On	3	Screw	Standard	11/16"	Chrome	
P-34-573	On-Off-On	3	Screw	Standard	11/16"	Chrome	
P-34-575	Mom On-Off-Mom On	3	Screw	Standard	11/16"	Chrome	
P-34-575Q ¹	Mom On-Off-Mom On	3	Blade	Standard	11/16"	Chrome	
D.P.S.T. (DOUBLE POLE - SINGLE THROW)							
P-34-574	On-Off	4	Screw	Standard	11/16"	Chrome	
D.P.D.T. (DOUBLE POLE - DOUBLE THROW)							
P-34-576	On-On	6	Screw	Standard	11/16"	Chrome	
P-34-577	On-Off-On	6	Screw	Standard	11/16"	Chrome	
P-34-580	Mom On-Off-Mom On	6	Screw	Standard	11/16"	Chrome	
P-34-580Q ¹	Mom On-Off-Mom On	6	Blade	Standard	11/16"	Chrome	
P-34-591Q ¹	Mom On-Off-Mom On	4	Blade	Standard	11/16"	Chrome	Reversing / Jumper / Blade Style
P-34-592	On-On	6	Screw	Standard	11/16"	Chrome	Reversing / Jumper / Screw Style
P-34-592Q ¹	On-On	6	Blade	Standard	11/16"	Chrome	Reversing / Jumper / Blade Style

¹Q = Quick Connect .250 Terminals

²L = Long Handle 1-1/2"

³Decorator style toggle switches designed with an O-Ring seal between toggle and bushing for splash proof reliability. Durable nylon housing, nylon face nut and brass terminals resist corrosion.



Standard Chrome Handle
(.250 Blade Terminals)



Long Chrome Handle
#8-32 Screw Terminals

Pictures are shown as a reference and may differ in appearance from the parts listed.

Heavy-Duty. Pollak Toggle Switches designed for your most high-current applications. Oversized internal copper contacts will carry up to 50 AMP current loads. Provides the longest possible service life. (Note: Quick-Connect Blade terminals will carry up to 30 AMPS.)

PART#	CIRCUITRY	# OF TERMINALS	TERMINAL TYPE	HANDLE TYPE	HANDLE LENGTH	HANDLE FINISH	DC VOLTS	DC AMPS
S.P.S.T. (SINGLE POLE - SINGLE THROW)								
P-34-212	On-Off	2	Screw	Standard	1"	Chrome	12	50
P-34-213	On-Off	2	Screw	Long	1-1/2"	Chrome	12	50
P-34-216	On-Off	2	Blade	Standard	1"	Chrome	12	30
P-34-219	On-Off	2	Screw	Standard	1"	Black	12	50
S.P.D.T. (SINGLE POLE - DOUBLE THROW)								
P-34-222	On-Off-On	3	Screw	Standard	1"	Black	12	50
P-34-220	Mom On-Off-Mom On	3	Screw	Long	1-1/2"	Chrome	12	50

SOLD INDIVIDUALLY

TOGGLE SWITCHES

E3



Heavy Duty. 25A at 12V DC, 15A at 24V DC. Standard or long handle. Universal application. Silver contacts. Mounting stem is nickel-plated brass 15/32"-32 thread, 15/32" long, fits panel up to 9/32" except where stated otherwise. Phenolic housing with plated steel cap. Nickel-plated brass mounting hardware. Blade terminals: .250 quick connect. Screw terminals: 6-32 screws.

Pictures are shown as a reference and may differ in appearance from the parts listed.



Standard Handle - 11/16" Long

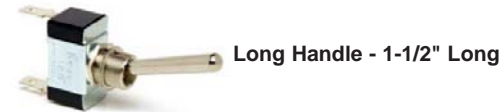

Long Handle - 1-1/2" Long



PVC Coated Housing with wire leads

PART#	CIRCUITRY	# OF TERMINALS	TERMINAL TYPE	HANDLE TYPE	HANDLE LENGTH	HANDLE FINISH	OTHER DESCRIPTION
S.P.S.T. (SINGLE POLE - SINGLE THROW)							
CH-05582	On-Off	2	Screw	Standard	11/16"	Nickel Plated Brass	
CH-05582-10	On-Off	2	8" Leads	Standard	11/16"	Nickel Plated Brass	PVC Coated
S.P.D.T. (SINGLE POLE - DOUBLE THROW)							
CH-55021-04	Mom On-Off-Mom On	3	Screw	Standard	11/16"	Nickel Plated Brass	
CH-55036	On-Off-On	3	9-1/2" Leads	Standard	11/16"	Nickel Plated Brass	PVC Coated
D.P.D.T. (DOUBLE POLE - DOUBLE THROW)							
CH-55057	On-Off-On	6	Blade	Long	1-1/2"	Nickel Plated Brass	

MEDIUM AND LIGHT DUTY TOGGLE SWITCHES

CH-55012



10 Amps @12VDC. OFF-ON. S.P.S.T. Ball Handle. Nickel-plated brass handle, facenut and mounting stem. Silver contacts. Mounting stem has 15/32"-32 thread. 15/32" Long. Fits panels up to 9/32" thick. Two blade terminals. Phenolic housing with plated steel frame. Keyway is in the down position.

P-34-500



2 Position. 20 Amps @12 VDC. S.P.S.T. ON-OFF. Knurled face nut and indicator plate. Back nut and terminal screws assembled.

P-34-513



2 Position. 10 Amps @12V. S.P.S.T. ON-OFF. 6" Leads.

ACCESSORIES

P-25-370



Toggle Boot with 15/32"-32 thread. Provides protection against salt spray and is resistant to weather and ozone. Can be used on toggle switches with 15/32" diameter mounting stem.

CH-81264



Toggle Boot Seal. Durable silicone rubber bonded to a standard 15/32"-32 thread nickel plated brass hexnut. When the nut is tightened to the stem of a toggle switch, the rubber forms an O-ring seal with the panel. Full boot completely covers a standard 11/16" handle. Boot seals and protects switches from moisture and dirt.

P-25-371



1/2 Toggle Boot. Same as toggle boot P-25-370 except allows toggle handle of any length to protrude. Accommodates toggle lever diameters from .155" - .240" except nylon handle series.

CH-05543-15



Recessed faceplate switch guard. Needs to be countersunk in a 2" hole. 3-3/16" diameter with three 7/32" holes on a 2-3/4" diameter circle. Requires a clearance depth of .890", not including clearance for a switch.

Toll Free: 800-922-6527 • Fax: 248-634-2022 • www.statewire.com

E4

CIRCUITRY DIAGRAMS

S.P.S.T. (Single Pole / Single Throw).

A two terminal switch which opens or closes one circuit.

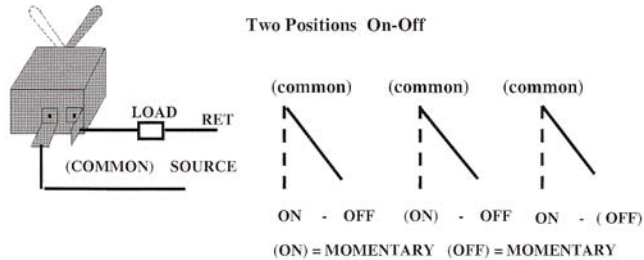

S.P.D.T. (Single Pole / Double Throw).

A three terminal switch that controls two single-wire circuits. Permits only one circuit to be energized at a time.

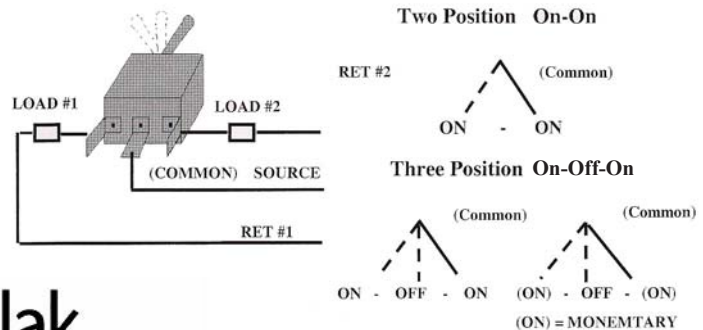

Pollak



D.P.S.T. (Double Pole / Single Throw).

A four terminal switch that controls one double wire circuit or two single wire circuits.

Two Positions On-Off
Two single wire circuits

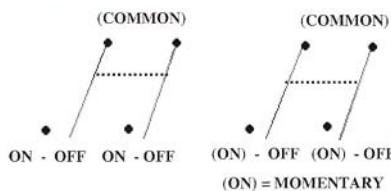
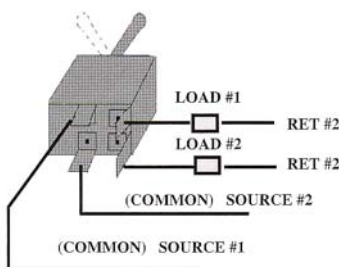

Two Positions On-Off
One double wire circuit

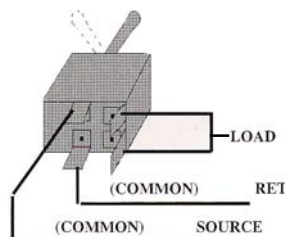

D.P.D.T. (Double Pole / Double Throw).

A six terminal switch that controls two double wire circuits permitting only one circuit to be energized at a time, or four single wire circuits permitting only two circuits to be energized at a time.

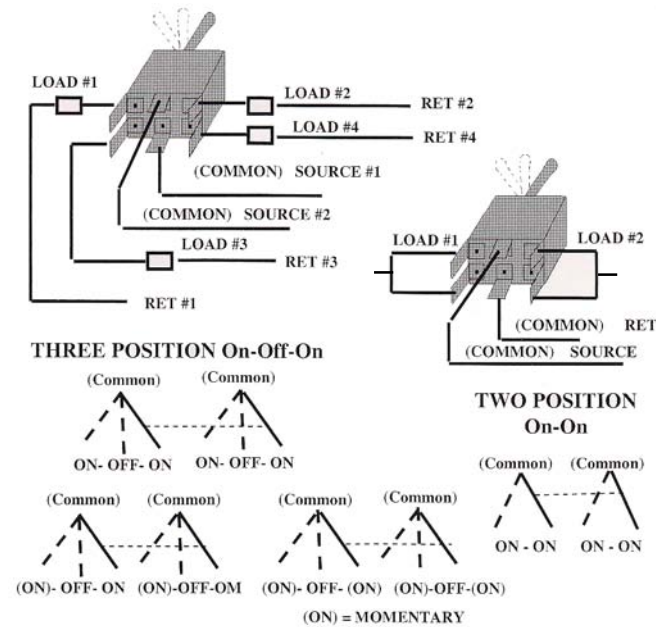

PART# GS-2144A

HEAVY DUTY ILLUMINATED ROCKER SWITCH

.250" Male Blade Contacts. Illuminated AMBER in "On" position. 1/2" round mounting hole.

Ratings: 20 Amps. 12 Volts DC. Standard Package - 5



State Wire and Terminal, Inc.

SEALED ILLUMINATED ROCKER SWITCHES

Rated 20 Amps at 12 VDC. Designed for complete protection against dust and moisture. Features include black plastic housing, nylon bezel, silver contacts, white lens with LED bulb and .250" blade terminals. May be used with Pollak's new single and modular mounting brackets.

Picture shown as a reference and may differ in appearance from the parts listed.



UNIVERSAL DESIGN ROCKER SWITCH

Rated 20 Amps. New Universal Design for Automotive, Truck, Bus, Marine and Recreational Vehicles. Snap-in mounting fits .830" x 1.450" panel cutout in .093" to .187" thick panels. .250" blade terminals. Nylon bezel black actuator and housing.



PART#	CIRCUITRY	NO. OF TERMINALS	TYPE OF TERMINALS
P-34-230	On-Off, S.P.S.T	4	Blade
P-34-240	Off-On-On, Progressive	6	Blade

PART#	CIRCUITRY	TERMINAL DESCRIPTION	NOTES
P-34-360	On-Off, S.P.S.T	3 Blade	Red Pilot Light



Cole Hersee

STANDARD ROCKER SWITCHES

PART# CH-56300-01

S.P.S.T. On-Off. 25 Amps. White actuator, bright metal bezel. Red dependent pilot light. Snap-in mounting to fit panels .06" through .25". Three screw terminals.



For Universal applications. 25A at 12VDC. Blade Terminals. Single Pilot Light and dependent illumination. Matte finish black bezel, actuator and housing. Snap-in mounting fits .83" by 1.45". Fits panels from .093" to .187" thick.



PART# CH-57013-08

D.P.D.T. Mom On-Off-Mom On. 25A at 12V DC. Moisture resistant plastic housing, bezel and actuator. Snap-in mounting to fit panels .06" through .25". Six blade terminals. White Actuator. Fits panel hole .83" by 1.45".

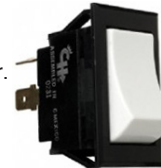

PART#	CIRCUITRY	TERMINAL DESCRIPTION	NOTES
CH-58328-04	On-Off, S.P.S.T	3 Blade	Red Pilot Light
CH-58328-11	On-Off, S.P.S.T	3 Blade	Green Pilot Light

2 POSITION PUSH-PULL SWITCHES



PART# P-35-306
EXTRA HEAVY DUTY. SPST
6-28V - 75 Amp D.C.
ON-OFF. Heavy duty die-cast body. Chrome plated knob. Copper screw terminals. Mounting stem 5/8" long, 15/32" dia.



PART# P-35-331
EXTRA HEAVY DUTY w/ RED METAL KNOB. SPST.
6-28V - 75 Amp D.C.
ON-OFF. Heavy duty die-cast body. Chrome plated red knob. Copper screw terminals. Mounting stem 5/8" long, 15/32" dia.



PART# P-35-300
MODERATE DUTY. SPST
25 Amp @ 6V, 15 Amps @ 12V.
ON-OFF. Ivory plastic knob. Mounting stem 5/8" long, 7/16" dia.



PART# P-33-402
MARINE - SPST
25 Amps @ 6V, 15 Amps @ 12V.
ON-OFF. Polished chrome face nut and chrome plated plastic knob. Brass back nut and washer. Mounting stem 1-1/4" long, 3/8" dia.



PART# CH-05007
HEAVY DUTY. SPST
10 Amp @ 12V DC, 6-36V
ON-OFF. 2 screw terminals. Tan plastic knob. Aluminum mounting stem 3/8"-32 thread, 5/8" long.

NORMALLY ON



PART# CH-50046
HEAVY DUTY. SPST
10 Amp @ 12V DC, 6-36V
ON-OFF. 2 Screw terminals. Black plastic knob. Aluminum mounting stem 3/8"-32 thread, 5/8" long.



PART# CH-M606
MARINE. SPST
10 Amp @ 12V DC, 6-36V
ON-OFF. Brass housing, plasticized. Two insulated copper wire leads, 12" long. Chrome-plated brass knob, 10-32 thread.



PART# P-24-359
MOMENTARY PUSH SWITCH
70 Amps @ 12V, 35 Amps @ 24V
 Silver contacts. Flush terminal screws in molded insulator. Housing rolled over insulator to seal out dust and moisture. Hex, back nut, bright polished face nut and black molded plunger. Mounting stem 5/8" long, 5/8" dia. Thread. Overall length 1-13/16", housing dia. 15/16".



PART# P-24-360
MOMENTARY PUSH SWITCH
70 Amps @ 12V, 35 Amps @ 24V
 Weather and dustproof. Same as P-24-359 except with P-25-358 cap and face nut, to seal out weather and dust.



PART# CH-09095
MOMENTARY PUSH-BUTTON SWITCH
HEAVY DUTY
35 Amps @ 12V, 20 Amps @ 24V
OFF-ON (Normally OFF). Silver contacts. Two screw terminals. Mounting stem 5/8"-32 thread, 21/32" long. Chrome plated button and face nut.



PART# CH-M608
PLASTIC COATED MOMENTARY SWITCH
2 POSITION
OFF-MOMENTARY ON
 10 Amp @ 12V. Two 18ga wire leads, 12" long. Mounting stem: Brass, 5/8"-32, 15/16" long, fits panels through 1/2" thick. Plasticized body sealed against moisture and dirt. Cap snaps over face nut.



PART# P-25-358
BLACK BOOT NUT ASSEMBLY
WEATHER and DUSTPROOF
 Neoprene rubber type boot nut assembly. With 5/8"-32 thread. Can be used on P-52-611 and P-33-200 and on other momentary switches with this mounting stem.



PART# CH-83280-03
THREADED CAP - BLACK
WEATHER and DUSTPROOF.
 Rubber cap is permanently fastened to the integral mounting nut by a rolled brass bezel. The deep threaded 5/8"-32 aluminum mounting nut assures a positive seal. Durable, resilient rubber, embossed "PUSH". Fits push button switches with a 5/8"-32 thread mounting stem.



PART# P-51-902
BATTERY MASTER DISCONNECT SWITCH
 Lever operated. 6-36V. 180 amps continuous capacity, 1000 amps in rush. S.P.S.T.(OFF-ON) two stud terminals. For battery circuit only. Does not disconnect alternator or generator field circuit. On vehicles equipped with alternators, engine must be shut off to avoid potential damage to alternator diodes.



PART# P-51-904
BATTERY MASTER DISCONNECT SWITCH
 Lever operated. 6-36V. D.P.S.T.(OFF-ON). Four stud terminals. For battery and alternator or generator circuit. Designed to break alternator circuit prior to battery circuit disconnect. Has .25" dia. Indexing post to prevent rotation and align switch. 180 Amps continuous capacity on large studs. 20 Amps continuous capacity on SMALL studs. 1000 Amps in rush on large studs.



PART# CH-75908
BATTERY MASTER DISCONNECT SWITCH
 Lever operated. 6-36V. S.P.S.T. (OFF-ON) Two stud terminals 1/2"-20. Disconnects battery circuit only. Electrical rating: 2000A intermittent. 30 seconds ON, 3 minutes OFF, 300A continuous. Mounting stem: 3/4"-16 thread. Fits panels up to 1/4" thick. Plated steel case. Sealed between shaft and mounting stem; case and terminal insulator.



PART# P-51-303
FACE PLATE
 For use with P-51-902, P-51-905, P-51-904 and P-51-907 Master Disconnect Switches. Polished aluminum with black letters. 2.5" diameter. Center hole .76" diameter. Thickness .032".



PART# CH-82065
FACE PLATE
 For Master Disconnect Switches. Polished aluminum with enamel finish. Fits Cole Hersee Disconnect Switches without indexing pin. 2-1/2" diameter.



PART# P-21-458
PRECISION BALL SWITCH
NORMALLY OPEN, Exposed Terminals.
 .01-5.0 DC Amp. 5.0-24.0 VDC. Screw terminals. 9/16"-18 Thread. 7/8" Hex.



PART# CH-96101
HORN BUTTON. SURFACE MOUNT.
 5 Amps @ 12V DC. Two screw terminals. Black plastic button, 13/16" diameter.



PART# P-52-623
DOOR JAMB SWITCH- SEALED. 5 Amps @ 12V
 Weather resistant plastic plunger and body. Accepts two bullet terminals. Fits panels .030" - .070" thick. Mounting hole .850" dia. max. Replaces: Ford OA1-13713, BOA-13713, B9MT-13713A, C3AZ-13713A

PART# P-33-104
MARINE STARTER SWITCHES
 (For Magneto applications)
3 POSITION. 10 Amps @ 12 VDC
 Glass filled Delrin housing. Stainless steel terminals. Molded Velox base. Special weather proofing seal and drain hole. Special long bushing allows mounting in panels up to 1-1/4" thick. 13/16" diameter mounting stem.

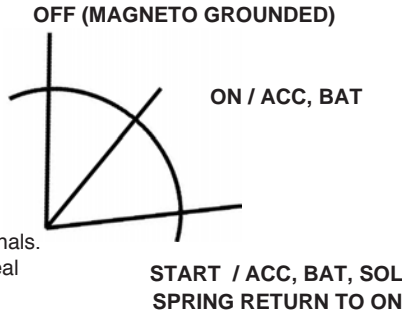

PART# P-33-105
MARINE STARTER SWITCHES
 (For Magneto applications)
3 POSITION. 10 Amps @ 12 VDC
 Special "Push to Choke" feature eliminates need for separate electronic choke switch. Switch mounts in panels up to 1/4" thick. 13/16" diameter mounting stem.

POLLAK IGNITION STARTER SWITCHES

BASE TYPES & CONNECTIONS¹

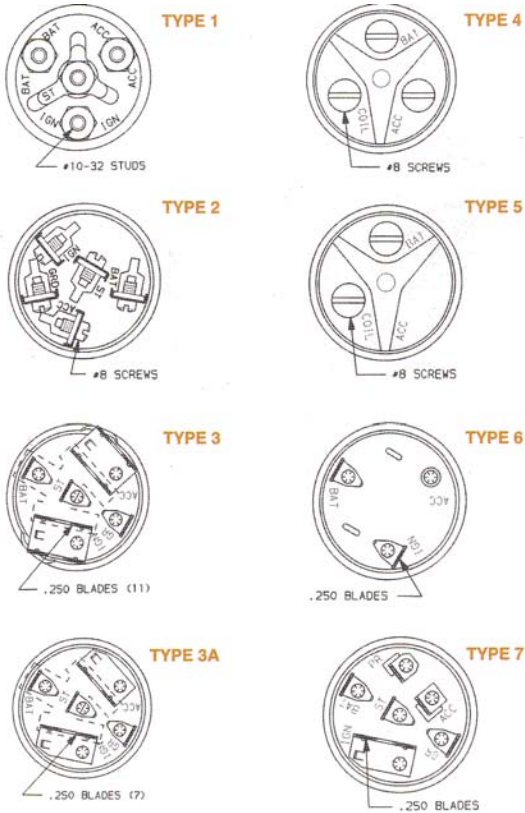

MOUNTING HOLE PATTERNS²

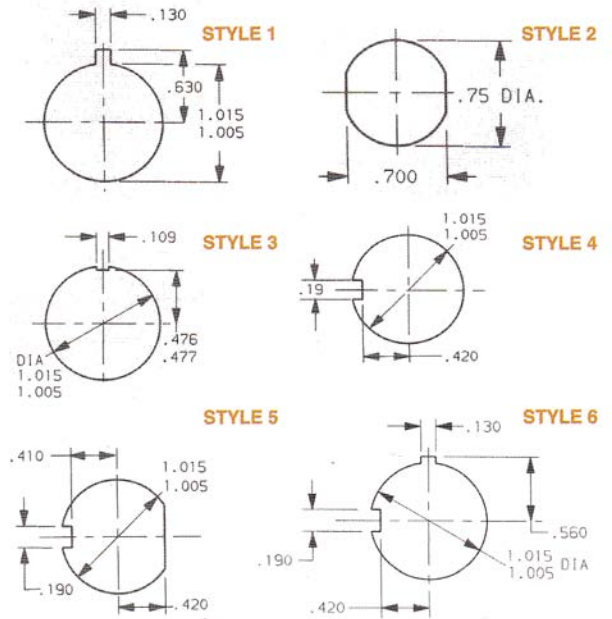

¹Base Types and Connectors:
 Base Types (3,3A & 7) fit Packard Connector 2984017
² Mounting Hole Pattern - MHP

TYPICAL RATINGS @ 14 VOLTS DC (50,000 CYCLES)		
IGNITION TERMINAL	ACCESSORY TERMINAL	START TERMINAL
8 Amps	30 Amps (Inductive)	75 Amps Make 20 Amps Break
Continuous current carrying capacity - 30 Amps @ 14V. Accessory terminal with 10 gauge wire.		

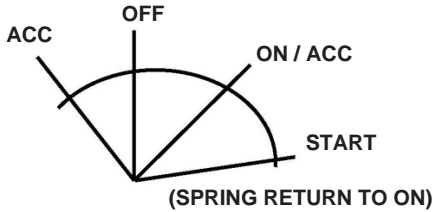

PART# P-31-610
IGNITION STARTER SWITCH
4 POSITION. 30 Amps @ 14V

Key removable in off position only. Switch compartment sealed against water entrance from lock end. Slightly flat for water escapement between housing and mounting nut. 1 lip seal.

BASE TYPE: 1 / MHP: 4

PART# P-31-104
IGNITION STARTER SWITCH
4 POSITION. 30 Amps @ 14V
Key removable in off position only. Momentary start and universal type die-cast housing. No starter lockout. No lip seals. Key code PK566.
BASE TYPE: 1 / MHP: 2

PART# P-31-180
IGNITION STARTER SWITCH
4 POSITION. 30 Amps @ 14V
Key removable in off position only. O-ring sealed base. Contact plated to incorporate center guide pin. Battery contact insulated from wiper contact in off position. 2 lip seals.
BASE TYPE: 1 / MHP: 5

PART# P-31-242
IGNITION STARTER SWITCH
4 POSITION. 30 Amps @ 14V
Momentary Start - Universal type die cast housing molded base-lock. Special lock-out feature that prevents the key from being turned to the "start" position without first going all the way to the "off" position.
BASE TYPE: 2 / MHP: 4

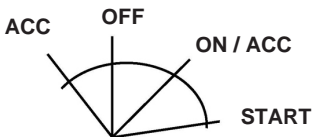

PART# P-31-114
IGNITION STARTER SWITCH / 4 POSITION. 30 Amps @ 14V
Key removable in off position only. Momentary start and universal type die-cast housing. No starter lockout. No lip seals. Key code various. Fits packard connector #2984017. Caution tag on ground terminal.
BASE TYPE: 3 / MHP: 1

PART# P-31-302
IGNITION STARTER SWITCH
3 POSITION. 30 Amps @ 14V

Key removable in off position only. Momentary start and universal type die-cast housing. Starter lockout. 1 lip seal. Key code universal.
BASE TYPE: 2 / MHP: 5

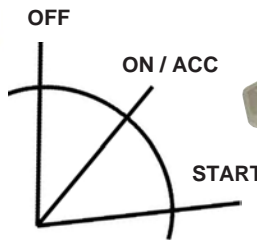

PART# P-31-297
IGNITION STARTER SWITCH
3 POSITION. 30 Amps @ 14V
Key removable in off position only. Momentary start and universal type die-cast housing. Starter lockout. 1 lip seal. Key code universal. Fits packard connector #2984017.
BASE TYPE: 3A / MHP: 4

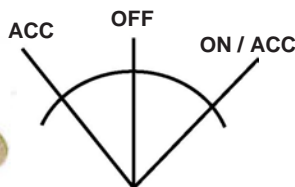

PART# CH-956-6307
IGNITION STARTER SWITCH
3 POSITION. ELECTRICAL RATINGS @ 12V DC: 10A Accessory, 10A Ignition
Key removable in off position only. 3 screws. Hencol lock, 2 keys. Sealed terminal insulator. O-ring seal in stem. No ground terminal. Mounting stem 3/4"-24 thread.

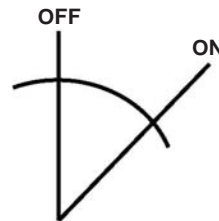

PART# P-31-602
IGNITION STARTER SWITCH
2 POSITION. 30 Amps @ 14V
Key removable in off position only. Momentary start and universal type die-cast housing. No starter lockout. Key code various.
BASE TYPE: 5 / MHP: 2



PART# CH-95512A
IGNITION STARTER SWITCH
2 POSITION. ELECTRICAL RATINGS @ 12V DC: 10A Ignition
Key removable in off position only. 2 screws. Hencol lock, 2 keys. No ground terminal. Mounting stem 5/8"-24 thread.

IGNITION STARTER SWITCH REPLACEMENT KEYS



PART# P-31-173-104
D-250 SERIES - BLANK KEY, COINED.
 Replacement key for P-31-132, P-31-139, P-31-180, P-31-191, P-31-272 and P-31-280.



PART# P-31-166-001
UNIVERSAL KEY SERIES - COINED, 2 KEYS PER RING.
 Pollak Logo and Lightning Bolt. Replacement keys for P-31-175, P-31-190, P-31-242, P-31-297, P-31-302, P-31-345 and P-31-610.



PART# P-31-600-103
PK556 SERIES - COINED, 2 KEYS PER RING.
 Pollak Logo. Replacement keys for P-31-104, P-31-114 and P-31-610. Standard Package - Set of 10



PART# CH-83357
HENCOL SERIES
 Patented Hencol lock and key system gives trouble-free performance. Heavy gauge steel. Plated to resist corrosion. Cole Hersee Logo. Replacement keys for CH-956-6307 and CH-95512A.

SOLENOID SWITCHES



Continuous Duty

Normally open contacts, SPST, one circuit. Off - On. Housings: Plated steel. Contacts: Copper 5/16"-24, hex nuts and lockwashers included. 200A solenoids have silver contacts. Coil, ignition and ground terminals: Steel 10-32 hex nuts and lock washers included. Bracket mounting holes 5/16" x 19/32" (7.9mm x 15.1mm) on two 13/64" centers (56mm).

Intermittent Duty

Normally Off, SPST, One Circuit: Off - On
 750 Amps make, 100 Amps break; 10sec On, 20min Off, except where noted. Copper terminals and contacts. Small ignition and ground terminals are 10-32 thread. Large contact terminals are 5/16"-24 thread. Hex nuts and lock washers are included. Bracket mounting holes 5/16" x 19/32" (7.9mm x 15.1mm) on two 13/64" centers (56mm).



12-V Continuous Duty Solenoid Insulated, with hardware. Flat bracket. S.P.S.T. Normally open contacts - Off-On. 6-24VDC. 85 Amps continuous, 150 Amps in rush.
P-52-307 Replaces: Delco 1114218, 223; Prestolite 15-132, 133, 236, 311, SAS-4201, 4202, 4313, 5203
P-52-315 Dust and moisture resistant.
P-52-324 Replaces: Prestolite 15-141, 196, 310, SAS-4401, 4408, 5401



GRAY PVC COATED*



Pictures are shown as a reference and may differ in appearance from the parts listed.

12 Volt DC continuous duty. 120 Amps in rush. Hex nuts and lock washers included. 3 terminals for metal frame ground systems. 4 terminal has insulated ground terminal for use with fiberglass or other nonconductive materials. Cadmium plated, nonbreakable heavy duty housing resists rust, gives long life in most any environment. Isolates starting battery. Assures primary battery power for starting engine and provides secondary battery current for auxiliary power. Full time charging of both batteries. Gives you early reuse of secondary battery.

PART#	CIRCUITRY	AMPS	VOLTS	TYPE	#OF CONTACTS	TYPE OF DUTY
COLE HERSEE						
CH-24106	SPST	85A	12V	Grounded	3 Terminals	Continuous Duty
CH-24143	SPST	200A	12V	Insulated	4 Terminals	Continuous Duty
CH-24117*	SPST	85A	12V	Insulated	4 Terminals	Continuous Duty
CH-24059	SPST	85A	12V	Insulated	4 Terminals	Continuous Duty
CH-24063	SPST	85A	24V	Insulated	4 Terminals	Continuous Duty
CH-24008	SPST	120A	24V	Insulated	4 Terminals	Intermittent Duty
POLLAK						
P-52-307	SPST	85A	12V	Insulated	4 Terminals	Continuous Duty
P-52-315*	SPST	85A	12V	Insulated	4 Terminals	Continuous Duty
P-52-324	SPST	85A	24V	Insulated	4 Terminals	Continuous Duty
TEKONSHA / BARGMAN						
TE-7000	SPST	60A	12V	Grounded	3 Terminals	Continuous Duty
TE-7001	SPST	60A	12V	Insulated	4 Terminals	Continuous Duty

*GRAY PVC COATED

E10 BOXES, BLOCKS AND VALVES

SOLD INDIVIDUALLY



PART# P-52-259
7 TERMINAL JUNCTION BOX
 7 stainless steel studs. Black ABS box.
 Hardware included -
 (2) #14 x 1-3/4" hex screws
 (7) #10-32 hex nuts with lock washers.
 (2) wire grommets & (4) hole plugs
 Dimensions: 8.06" L x 3.2" W x 2.09" H.



PART# P-52-248
10 TERMINAL JUNCTION BOX
 10 stainless steel studs. Black ABS box.
 Hardware included -
 (4) #10-24 x 1-1/2" hex screws
 (10) #10-32 hex nuts with lock washers
 attached. (2) wire grommets & (4) hole plugs
 Dimensions: 7.5" L x 3.75" W x 2.5" H.



PART# P-52-249
7 CIRCUIT BREAKER JUNCTION BOX
 7 clips. Black ABS box. Steel bracket.
 Hardware included -
 (4) #10-24 x 1-1/2" hex screws
 (10) #10-32 hex nuts with lock washers
 attached. (2) wire grommets & (4) hole plugs
 Dimensions: 7.5" L x 3.75" W x 2.5" H.



PART#	NO. OF GANGS	LENGTH	MOUNTING HOLE CENTER
P-52-244	4	4.5"	0.62"
P-52-245	6	6"	1.25"
P-52-246	8	7.5"	1.87"
P-52-247	10	9"	2.50"

TERMINAL BLOCKS
Non Feed-Thru
 Current 30 Amps @ 12 VDC. 4 to 10 steel studs on .750" centers and a "dog point" to guide nut onto 10-24 thread. Plastic base and steel studs, barrier strips.

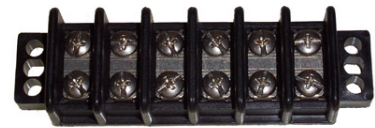

PART# P-52-271
TERMINAL BLOCK
With Independent Feeds
 Current 20 Amps @ 12VDC. 6 gang - 12 screw. Terminals will accept maximum wire size of awg #12. #6-32 phillips slotted combination screws. Plastic base & barrier strips, steel screws and brass terminals.

FUEL TANK SELECTOR VALVES



PART# P-42-159
LIGHT TRUCK 6-PORT MOTOR DRIVEN VALVE
 Incorporates six ports including return. Draws .5 Amps max @ 12 volts. Fits 3/8" I.D. hose for fuel supply and 5/16" hose for return lines. Mounting holes: two 5/16" threaded nuts on 13/16" centers. Valve remains in actuated position after power is disconnected. For new installations P-42-203 and P-34-592 are required.



PART# P-42-203
MOTORIZED VALVE CONNECTOR
 Type 5 wire. Weather proof. Pigtail: 5" 18 gauge wires.



PART# P-42-151
3 PORT MOTORIZED SELECTOR VALVE
 Motor operation permits substantially higher pressures than solenoid-actuated valves. Valve remains in actuated position after power is disconnected, reducing the possibility of returning fuel to incorrect tank. Installation sheet included. Incorporates three ports including return. Draws .5 Amps max @ 12 volts. Fits 3/8" I.D. hose for fuel supply. Mounting holes two 5/16" threaded nuts on 1-3/16" centers.



PART# P-42-201
FACE PLATE
 Material: Bright Nickel Plated Steel
 Legends: AUX, MAIN



PART# P-34-592
TOGGLE SWITCH
 (See description on Page E2)

PART# P-42-302
KIT INCLUDES 6-PORT MOTORIZED VALVE AND CONNECTOR
 Has the same specifications as P-42-159. Contains Light Truck 6-Port Motor Driven Valve (P-42-159) and Motorized Valve Connector (P-42-203).

PART# P-42-308
KIT INCLUDES 3-PORT MOTORIZED VALVE; CONNECTOR, SWITCH AND FACE PLATE
 Has the same specifications as P-42-151. Contains 3-Port Motorized Selector Valve (P-42-151), Motorized Valve Connector (P-42-203), Toggle Switch (P-34-592) and Face Plate (P-42-201).

ELECTRONIC BRAKE CONTROLS



Figure 1



Figure 2



Figure 3



Figure 4



Figure 5



Figure 6

PART#	DESCRIPTION	FIG
WB-5085315	Breakaway System for 1-3 axle trailers	1
WB-80500	POD Brake controller for 1-2 axle trailers	2
LM-47235	Impulse Electronic Brake Control	3
TE-9030	Tekonsha 9030 Voyager® for 2&4 brake systems.	3
WB-2023	5 Amp/Hr sealed rechargeable battery (12Volts)	4
LM-20010	Breakaway switch with Cable Bulk	5
TE-2010	Breakaway switch with 48" wires	5
TE-2010A	48" Replacement cable & Nylon Pin Assembly	5
TE-2026	Shur-Set III Breakaway System	6

5704 SERIES PENDANT STATION (Single Speed)



PART# ER-5704 (4 BUTTON)
Built-in strain relief bracket. Rubber enclosure covers buttons to prevent outside contaminants from entering enclosure. Standard legend plates and cord grip included with each pendant station. Two-piece enclosure simplifies field wiring. Soft pressure and positive indent switches provide optimum tactile feedback you can feel when switch has been engaged. Contacts rated at 10A/125VAC. NEMA Types 1, 3, 4 & 12. UL listed and CSA certified. Also available in 2 to 8 button configurations and two-speed models.

COILED CABLE ASSEMBLY WITHOUT ENDS



PART# TCA-16/5X20NE
Synthetic Rubber Jacket. 20' Working length. 16AWG, 5 conductors. 600V Cord. Temperature Rating 90° C (194°F). UL Type: SOOW - heavy duty. 65/347 Stranding. UL and CUL listed.

MOLDED TRAILER CONNECTORS

ALL WIRES ARE COLOR-CODED TO MEET RV REQUIREMENTS
(USE BOTH PART NUMBERS WHEN ORDERING SETS)

18 Gauge

FEMALE ENDS (Vehicle) MALE ENDS (Trailer)

Black



1WPT-12 (12" wire) (sold in pairs only)

Yellow, Green & Brown



3WF-12 (12" wire) 3WM-12 (12" wire)

Yellow, Green, Brown & White



4WFF-12 (12" wire) 4WFM-12 (12" wire)
4WFF-48 (48" wire) 4WFM-48 (48" wire)
4WFF-60 (60" wire)
4WFF-72 (72" wire)

Yellow, Green, Brown, White & Blue

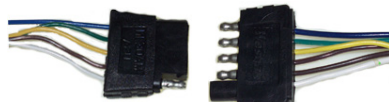

5WFF-72 (72" wire) 5WFM-48 (48" wire)

LOOPS

Red and Black



2WPT10-15L (10ga) 15" Wire
2WPT14-15L (14ga) 15" Wire

18 Gauge

Yellow, Green, Brown & White



4WF-15L (15" wire)
4WF-36L (36" wire)
4WF-60L (60" wire)

ELECTRONIC TAILLIGHT CONVERTER



PART# PM-12-751EV
This compact, heavy duty model saves time and money to install because the converter circuit is built-in with the 4-way flat pigtail. Allows vehicles with amber turn signal to tow trailer with red turn signals.

TRAILER HARNESS

5 Wire wishbone harness. Eliminates jumpers or cross over wires. Industry standard color code (White, Green, 2 Brown & Yellow). Splits at trailer tongue. (18" ground). 18 Gauge.

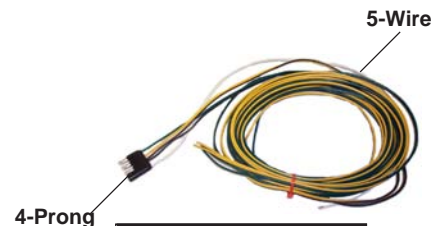

PART#	LENGTH
4WFM-20Y	20 Foot
4WFM-25Y	25 Foot

E12 TRUCK & TRAILER PRODUCTS

SOLD INDIVIDUALLY

TRAILER ADAPTERS



FIGURE 1



FIGURE 2



FIGURE 3



FIGURE 4



FIGURE 5

PART#	DESCRIPTION	FIG
P-12-717	Adapts 6-way Round (Pin) to a 4-way Flat (Pin)	1
P-12-716	Adapts 7-way Blade to a 4-way Molded Connector.	2
P-12-719	Adapts 7-way Blade to a 6-way Round (Pin). Center pin electric brake.	3
P-12-729	Adapts 7-way Blade to a 6-way Round (Pin). Center pin auxiliary.	3
LM-47565	Adapts 7-way RV (flat pin) to standard 6-way Round & 4-way Flat. Center pin auxiliary.	4
P-12-718	Adapts 7-way Blade to a 5-way Molded Connector.	5

RV ADAPTER



PART# 30-15

Weather resistant. Easy grip round adapter fits comfortably in any size hand. Constructed from durable PVC. 30 Amp (125 Volt) to 15 Amp (125 Volt) straight adapter.

MULTI-TOW 7:4 ADAPTER W/CHRYSLER OEM PLUG



PART# LM-42145

Gives you the ability to tow trailers with different wiring connectors from the same OEM connector. Simply replace the 7-way connector that came with your vehicle. Patented design. Weatherproof.

CHRYSLER OEM TO P-11-893 ADAPTER



PART# P-11-933

Rectangular-to-round harness adapter. Fits Chrysler harnesses. Mates with Pollak socket P-11-893.

5TH WHEEL T-CONNECTOR ADAPTER



PART# P-11-932

Adapter for 5th wheel and bumper mount sockets. Quickly & easily installs in a second RV socket. Plug and Play without splicing into OEM harness. Fits GM, Ford trucks and SUV's. Fits Chrysler trucks and SUV's when used with P-11-933 adapter. Mates with P-11-893 socket.

7-WAY RV OEM STYLE KIT WITH 4FT CABLE



PART# P-11-898

12 Volt, 30 Amps. Includes P-11-893 socket, P-12-711U bracket, interlocking connector and 4' harness assembly with 0.5" convoluted tubing, 7-wire leads are color-coded to RVI standards. Interlocking connector seals out moisture, eliminates loose wiring and forms weather-tight, non-corrosive assembly. For new installations or replacement of damaged sockets and wiring harnesses. Includes mounting hardware and installation instructions.

7-WAY RV OEM STYLE SOCKET



PART# GM-12191503
For GM
(TWIST LOCK)



PART# P-11-893
For
Chrysler & Ford

Pollak's sealed RV socket is designed to be dependable in one of the harshest mounting environments for an electrical device - an exposed external mounting under the rear bumper of a sport utility or pick-up truck. This connector design continues to earn the distinction of becoming the industry standard. Manufactured from **high-impact nylon** that solves corrosion problems and eliminates rusting when mated with special interlocking sealed connector. Socket lid features stainless spring and runner gasket to guarantee against moisture intrusion when closed. Socket lid is designed with slot to prevent sand and dirt from impairing closure and lid has wiring diagram on cover to facilitate installation. Socket lid drain slot is angled down for drainage. Terminal pins are tin plated copper alloy providing higher conductivity and less resistance. Terminal pins are sealed at the back of socket with silicone sealant to prevent moisture from making contact with mating connector.

State Wire and Terminal, Inc.

SOLD INDIVIDUALLY

PLUGS AND SOCKETS

E13



RV 7-WAY BLADE CONNECTORS



Plastic connectors eliminate rusting, poor appearance and difficulty in plug removal. Design offers dual grips for ease of plug removal from socket and incorporates vinyl inserts to keep out dirt and moisture. Interior design prevents internal short-circuiting, and the safety latch prevents damage from accidental pull-away. Color coded to RVI standards.

POLLAK PART#	BARGMAN PART#	DESCRIPTION
P-12-700		Metal Complete Set
P-12-702		Metal Trailer End
P-12-703		Metal Vehicle End
P-12-705	WB-5077004	Plastic Complete Set
P-12-706	WB-5077003	Plastic Trailer End
P-12-707	WB-5077001	Plastic Vehicle End
P-12-701U	WB-5077070	Steel Plated Mounting Bracket
P-12-711U	WB-5077071	Black Powder Coat Mounting Bracket

Metal connectors are heavily plated for maximum weather and corrosion resistance. Stainless steel cover spring. Jumbo welded pistol grip. Unique safety latch prevents damage from accidental pull-away. Specially designed vinyl inserts keep out dirt and moisture. Color coded to RVI standards.



RIGHT ANGLE MOUNTING BRACKET
Black Powder Coat for protection against rust and corrosion.



RIGHT ANGLE MOUNTING BRACKET
Constructed of heavy gauge steel.

7-WAY HEAVY DUTY TRUCKING - PLUGS

Meets and exceeds all SAE J560 standards. Floating pins for ease of alignment and maximum contact. Will accept the widest range of wire gauges, from #16 wires to #8 ground wire. Interchangeable with all competitive ATA types. Tapered design fits comfortably and conveniently for easy hand-position pull. Jumbo finger pull grips and two hang-up holes. High-impact cyclolac interior with extended lip for easy removal and replacement. Solid brass terminal screws. 40 Amps continuous duty @ 6-28 VDC. WeatherBeater **EXTRA** seal accommodates .450" minimum cable diameter.

PART#	TYPE	DESCRIPTION
P-11-700	Metal	Standard Plug
P-11-702	Metal	Standard Plug w/Cable Guard
CH-01255	Metal	Standard Plug w/Cable Guard
P-11-900	Metal	Weather Beater Plug
P-11-902	Metal	Weather Beater Plug w/Cable Guard
P-11-704	Nylon	Standard Plug
P-11-710	Nylon	Standard Plug w/Cable Guard
P-11-904	Nylon	Weather Beater Plug
P-11-910	Nylon	Weather Beater Plug w/Cable Guard



7-WAY HEAVY DUTY TRUCKING - SOCKETS



PART#	TYPE	DESCRIPTION
P-11-720*	Metal	Solid Pin - 2 Hole Mount Socket
P-11-721	Metal	Split Pin - 2 Hole Mount Socket
P-11-737 ¹	Metal	Split Pin - 2 Hole Mount Socket w/Breaker
P-11-723*	Nylon	Solid Pin - 2 Hole Mount Socket
P-11-724	Nylon	Split Pin - 2 Hole Mount Socket

*20 amps

Only Solid Pin Sockets meet and exceed all SAE J560 standards*. Floating pins for ease of alignment and maximum contact. Will accept the widest range of wire gauges, from #16 wires to #8 ground wire. Self grounding (die-cast only). Optimum slant mount and drain slot rid housing interior of accumulated moisture. Stainless steel spring. Recommended mounting hole = 2" Dia. 40 Amps continuous duty @ 6-28 VDC.

ACCESSORIES

<p>P-11-761 RUBBER SOCKET BOOT Seals against dust and moisture. 1.5" long. For .460" - .720" diameter cable.</p>	<p>PART# P-11-762 RUBBER PLUG BOOT Seals against dust and moisture. 2.5" long. For .460" - .720" diameter cable.</p>	<p>P-11-763 CABLE GUARD Plated steel, 3.56" long.</p>	<p>P-11-771 PLATED SOCKET BRACKET</p>
--	--	---	---

Toll Free: 800-922-6527 • Fax: 248-634-2022 • www.statewire.com

6-WAY METAL CONNECTORS - PLUGS, SOCKETS & ACCESSORIES



P-11-603

P-11-604

P-11-605



P-11-607

P-11-608

P-11-609

High impact interiors are keyed for proper assembly. Brass terminal pins for best conductivity. Terminals accept up to #12 gauge wires. Plug available with or without cable guard. Replaceable plug interior helps keep down maintenance costs. Plated steel cable guard prevents cable chafing. Two 1/4" mounting holes on 6-way sockets, are 2-7/8" on center. Mounts through 1-3/8" hole.

PART#	DESCRIPTION
P-11-603	Plug & Enclosed Socket
P-11-604	Plug
P-11-605	Plug w/Cable Guard
P-11-607	Open Back Socket
P-11-608	Socket with rubber boot
P-11-609	Enclosed Socket

ACCESSORIES

PART# P-11-617 CONNECTOR BRACKET

Designed to fit under the trailer tongue, ball or 2-hole frame mounting. Heavy gauge steel zinc plated.



PART# P-11-627 CONNECTOR BRACKET

Designed to fit under the trailer tongue, ball or 2-hole frame mounting. **Black Zinc** plated for protection against rust and corrosion.



4-WAY METAL CONNECTORS - PLUGS & SOCKETS



P-11-400
HEAVY DUTY



P-11-402
HEAVY DUTY



P-11-403



P-11-404
HEAVY DUTY



P-11-408



P-11-409



P-11-410

PART#	DESCRIPTION
P-11-400	Socket & Plug Complete
P-11-402	Plug
P-11-403	Plug, w/Cable Guard
P-11-404	Heavy Duty Connector Socket
P-11-408	Chrome Diecast Socket & Plug
P-11-409	Chrome Diecast Plug
P-11-410	Chrome Diecast Socket

Extended exterior and socket conceals terminals. Unique cable clamp prevents chafing, gives more cable support and saves installation time. Integral finger grips for positive pull and plug never shakes loose. Stainless steel spring. Dust and water resistant. Heavy duty terminals accept up to #12 gauge wire. Two 1/4" mounting holes on 4-way sockets are 2-7/8" on center. Mounts through 1-3/8" dia. hole.

BATTERY JUMPER TERMINALS

POLLAK PART#	COLE HERSEE PART#	COLOR
P-52-138	CH-46210-02	RED
P-52-139	CH-46210-03	BLACK



Jumper terminals designed to provide remote mounting for battery connections either inside or outside of the vehicle. Easily installed, the positive terminal can be individually used or in conjunction with the negative terminal as a pair. Rubber caps, solid brass studs, brass hex nuts and brass lock washers. Dimension for grooved contact post: 13/16" dia., 1-1/8" long. Red cap - Positive terminal. Black cap - Negative terminal.



Cole Hersee

TARPING 2-POLE POWER TAKE-OFF CONNECTORS

Provides a high-integrity two-circuit path for on-and off-road vehicles and in agricultural applications. The two-pole power take-off is perfect for tarping applications, but it is also used in lift gate connections and to supply power to a broad range of auxiliary equipment that's part of the truck or utility vehicle. It also finds use in powering on-site equipment. Socket and Plug are made of diecast zinc with vertical aligned brass contacts. Socket has a spring loaded cover and the plug latches solidly with the socket. The plug comes with a durable flexible spring coil to protect its wires. Set is perfect for tarping applications and on-off road vehicles for agricultural needs. Termination accepts 6 gauge wire, polarized.

PART#	DESCRIPTION
CH-11041-06	Power Take-off Socket
CH-11042-05	Power Take-off Plug
CH-11250-01	Power Take-off Plug & Socket



CH-11042-05



CH-11041-06



CH-11250-01

Pollak



SINGLE POLE METAL CONNECTORS - PLUG & SOCKET

This rugged Single-pole Connector has a continuous duty capacity of 300 Amps, and is ideal for almost all heavy-duty power applications on trucks, agricultural equipment, utility vehicles, winches, light air craft ground equipment, etc. The connector is interchangeable with competitive brands. Provides power for auxiliary equipment from battery.

PART#	DESCRIPTION
P-11-850	Metal Socket & Plug
P-11-851	Metal Socket
P-11-852	Metal Plug



P-11-850



P-11-851



P-11-852

ELECTRICAL TERMS

AMPS - Electrical unit indicating rate of flow of electricity through a circuit.

CIRCUIT - Path taken by electrical current flowing through a conductor from one terminal source of supply to another.

CURRENT - The movement of electrons through a conductor from one terminal source of supply to another.

DOUBLE POLE - A switch that operates simultaneously in two separate electric circuits.

DOUBLE POLE / DOUBLE THROW - D.P.D.T. A switch that has six terminals and is used to connect one pair of terminals to either of the other two.

DOUBLE POLE / SINGLE THROW - D.P.S.T. A switch that has four terminals and is used to connect or disconnect two pairs of terminals simultaneously

DOUBLE THROW - A switch that alternately completes a circuit at either end of its extreme positions.

INDUCTIVE LOAD - Initial Amps needed to engage a circuit and/or a load which allows a momentary flow of current when a circuit is open. Devices that create inductive loads are typically motor coils and solenoids.

LAMP LOAD - Light bulb current expressed in Amps at a rated voltage.

MOMENTARY- Momentary action is obtained by holding switch in position with pressure. Upon release the switch returns to the previous position.

REVERSING - Reversing action is obtained by reversing the polarity of a switch with jumper wires or blades to change the rotation of a motor. Typical applications are winches, plows, radio antennas and fuel selector valves.

SINGLE POLE - A switch that opens, closes, or changes connections in a single conductor of an electrical circuit to a common contact.

SINGLE POLE / DOUBLE THROW - S.P.D.T. A three terminal switch for connecting one terminal to either of two other terminals.

SINGLE POLE / SINGLE THROW - S.P.S.T. A two terminal switch which opens or closes one circuit.

SINGLE THROW - A switch that opens, closes, or completes a circuit at only one of the extreme positions of its actuator.

VOLT - The unit that measures the potential difference in electrical force or "pressure" between two points on a circuit.

WATT - The unit of power that indicates the rate at which a device converts electric current to another form of energy, either heat or motion.

Toll Free: 800-922-6527 • Fax: 248-634-2022 • www.statewire.com



EVACUATOR® PLUS

The **EVACUATOR® PLUS** has extremely low current draw, thus prolonging battery life. A wide range of decibel outputs are available to meet every application. Compact design requires only 6.7 in² (43.2 cm²) mounting space. Universal mounting comes complete with heavy-gauge plated steel mounting bracket. The **dual-function** feature allows the alarm to produce two distinctly different tones by reversing polarity; normal polarity produces a pulse tone and reversed polarity produces a constant-on tone. **Meets J994 and OSHA requirements for motor vehicles and material handling equipment.**

PART#	DESCRIPTION	DECIBELS	VOLTAGE
TT-210339	Single-Function	97	12-24
TT-210331	Dual-Function	97	12-48
TT-210333	Dual-Function	107	12-48
TT-210335	Dual-Function	112	12-48

REACTOR® ALARMS

Reactor alarms **automatically adjust** to changing noise environments, eliminating the confusion regarding alarm selection. State-of-the art, solid-state electronics self-adjust to a minimum of 5dB above the surrounding noise levels, thus reducing irritation, complaints and hearing impairments. **Meets J994 and OSHA requirements.**

PART#	DESCRIPTION	DECIBELS	VOLTAGE
TT-210350	Nylon Housing	77 - 102	12-24
TT-210504	Plastic Housing	87 - 112	12-24



Pollak



PART# P-41-820 (97 db)

The rugged and compact Pollalert allows replacement of unnecessarily large and bulky alarms currently used on light and medium duty trucks, dump trucks, motor homes, campers, electric fork lifts and other similar applications. Multi-voltage - 12-24 volts, reverse polarity protected. Voltage spike protected. Current draw less than 0.3 Amps. Solid state electronics. Certified conformance to SAE J994, type C. Meets State, Federal and US Army Corps of Engineers' requirements. Size 4"W x 2.0"D x 2.5"H. Mounting - two .300" dia. holes on 3.25" centers. Made of high impact non-corroding plastic. Can be used on positive and negative ground vehicles. Compact size allows for horizontal or vertical mounting in protected areas. Operates in temperature ranges (-40°F to 170°F).

PART# P-41-822 (107 db)

For use in medium to light duty applications where a louder noise level is required. Single level 107dB. Voltage spike protected. 12-24 Volts. Current draw less than 0.3 Amps. Solid state electronics. Certified conformance to SAE J994, type B. Meets State, Federal, OSHA, Bureau of Mines and US Army Corps of Engineers' requirements. Size: 4"W x 2.0"D x 2.5"H. Mounting - two .300" dia. holes on 3.25" centers. Made of high impact non-corroding plastic. Steam cleanable. Can be used on positive and negative ground vehicles. Compact size allows for horizontal or vertical mounting in protected areas. Operates in temperature ranges (-40°F to 170°F).



PART# P-41-706 UNIVERSAL BACK-UPALARM SWITCH

Switch for vehicles not equipped with automatic back-up light circuit. Mounts adjacent to reverse shift. Spring loaded lever permits over-travel. Normally off. 2.5 Amps.

QUICK INDEX SECTION F

F1

LED, Incandescent, Trailer and Emergency Lighting / Lighting Accessories

- F2-3** LED: Stop, Turn and Tail Lights
- F3-4** LED: Side Marker and Clearance Lights
- F4** LED: Back-up and Utility Lights
- F5-6** Stop, Turn and Tail Lights
- F7-8** Side Marker and Clearance Lights
- F9** Back-up, Utility and Tractor Implement Lights

- F10** License Plate Lights and Accessories
- F11** Plugs and Pigtails
- F11-12** Grommets
- F12-13** Brackets and Mirrors
- F13-14** Trailer Lighting and Accessories
- F15-16** Emergency Lighting

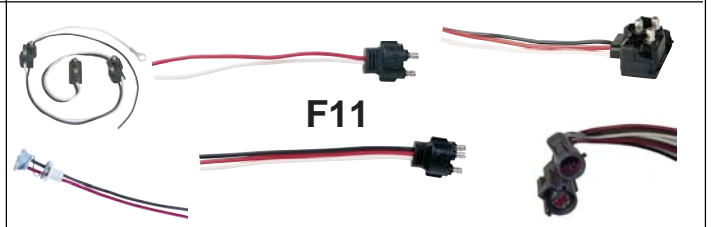
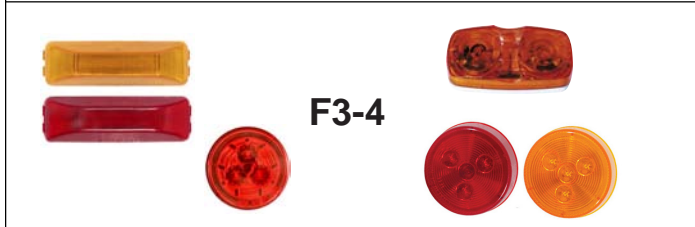
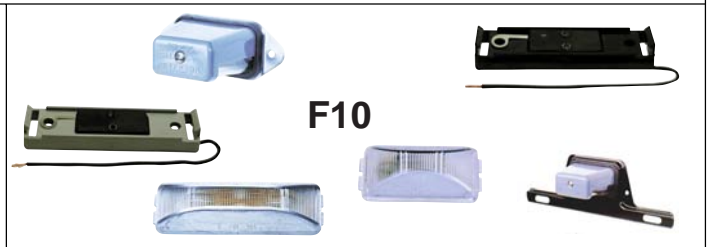



STOP, TURN AND TAIL LIGHTS



PART#	DESCRIPTION
OP-STL22RB	Red LED light
OP-STL22RCB	Red diodes, clear lens LED light
OP-A70GB	Mounting grommet
OP-A45PB	3-wire straight pigtail
OP-A47PB	3-wire right angle pigtail

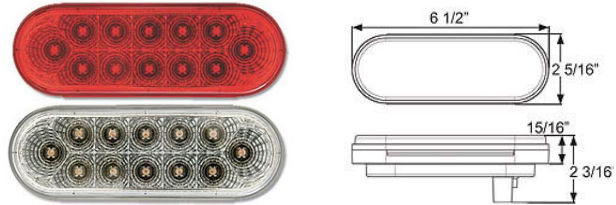

6" Oval sealed LED stop/turn/tail light. **Miro-Flex™ faceted reflector** design provides increased light output and a contemporary appearance while maintaining a traditional footprint. Series includes flush mount stop/turn/tail light. **12 diodes** for bright dependable performance. Requires mounting grommet and plug for complete installation. Accepts industry standard 3-prong plug for easy retro-fit of incandescent lights. Meets DOT FMVSS 108 requirements in any 360° position. Bright and dependable performance. Sonically sealed, waterproof lens protects against corrosion. All weather molded plastic housing and durable lens protect against corrosion. **OP-STL22RB** features red LEDs and red lens. **OP-STL22RCB** features red LEDs with Crystal Clear™ lens.

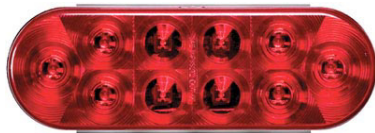

PART#	DESCRIPTION
OP-STL72AB	Amber LED light
OP-STL72RB	Red LED light
OP-A70GB	Mounting grommet
OP-A45PB	3-wire straight pigtail
OP-A47PB	3-wire right angle pigtail



Sealed, flush mount, **red** LED 6" Oval stop/turn/tail light. **10 super diodes** for bright, dependable performance. Requires mounting grommet and plug for complete installation. Accepts industry standard 3-prong plug for easy retro-fit of incandescent lights. Meets DOT FMVSS 108 requirements in any 360° position. Bright and dependable performance. Sonically sealed, waterproof lens protects against corrosion. All weather molded plastic housing and durable lens protect against corrosion. Available in both 12 volt and 24 volt models.

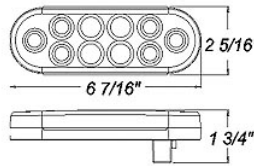

Sealed, flush mount, **amber** LED 6" Oval parking/rear turn signal light. **10 super diodes** for bright, dependable performance. Requires mounting grommet and plug for complete installation. Accepts industry standard 3-prong plug for easy retro-fit of incandescent lights. Meets DOT FMVSS 108 requirements in any 360° position. Bright and dependable performance. Sonically sealed, waterproof lens protects against corrosion. All weather molded plastic housing and durable lens protect against corrosion.

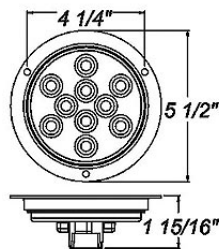

PART#	DESCRIPTION
OP-STL42RB	Red LED tail light
OP-A45PB	3-wire straight pigtail
OP-A47PB	3-wire right angle pigtail

4" Round LED sealed, flange mount stop/turn/tail light. **10 super diodes** for bright, dependable performance. Features sonically sealed, waterproof lens and housing in a single unit. Accepts industry standard 3-prong plug for easy retrofit of incandescent lights. Requires plug for complete installation.

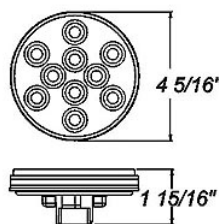

OPTRONICS	PETERSON	DESCRIPTION
OP-STL43RB	PM-417R-2	Red LED light
OP-A45GB	PM-426-18	Mounting grommet
OP-A45PB	PM-431-491	3-wire straight pigtail
OP-A47PB	PM-421-491	3-wire right angle pigtail

4" Round sealed LED stop/turn/tail light. Flush mount. Accepts industry standard 3-prong plug for easy retrofit of incandescent lights. Meets DOT FMVSS 108 requirements in any 360° position. **10 super diodes** for bright, dependable performance. Features sonically sealed, waterproof lens and housing in a single unit. All-weather molded plastic housing and durable lens protect against corrosion. Requires mounting grommet and plug for complete installation. **OP-STL43RB** features red LED's and red lens. **PM-417R-2** Piranha® LED. Features an increased operating range of 9-32 volts. Regulated design provides voltage protection and consistent light output over entire voltage range.



Universal stud-mount LED stop/turn/tail lights for under 80" applications. **OP-STL8RB** is 6-function: stop, turn, tail, rear reflex, side marker and side reflex. The seven-function **OP-STL9RB** is the same as the OP-STL8RB but includes license illuminator. All-weather molded plastic housing and durable lens protect against corrosion. Mounts on 2" centers, grounds through mounting studs.

PART#	DESCRIPTION	DIODES
OP-STL8RB	Red LED tail light	11
OP-STL9RB	Red LED tail light with license light	14

7" Round LED Bus and Transit Lights. **31 Diodes**. **OP-STL90RB** is an LED red stop/tail/reflex reflector light for surface mount. **OP-STL90AB** is an LED amber rear turn signal light for surface mount. Mounting gasket included. Ground wire.

PART#	DESCRIPTION
OP-STL90RB	Red LED stop / tail light
OP-STL90AB	Amber LED turn signal

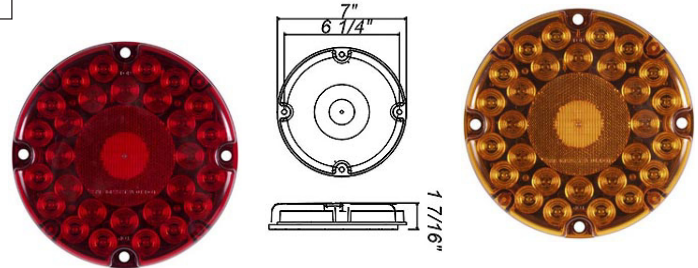
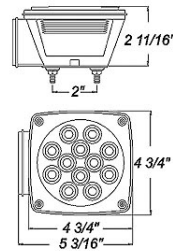

SIDE MARKER / CLEARANCE LIGHTS

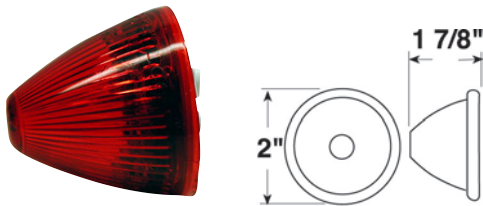

PART#	DESCRIPTION
PM-166R	Red light
PM-162-49	Plug, 6" lead
PM-146-18	Flush mount grommet

2" Piranha® LED Beehive clearance/side marker light. **5 diode** LED light functions as clearance, side marker or rear tracking light. Features sealed lens and housing. Operates from 9-16 volts. Requires mounting grommet and 2-wire plug to complete installation.

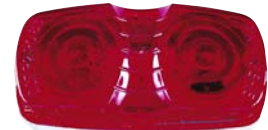

PART#	DESCRIPTION
OP-MCL45AB	Amber light
OP-MCL45RB	Red light

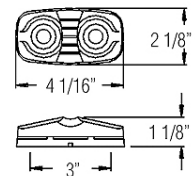

Bulls Eye LED clearance or side marker light. **6 Diodes**. Surface mount white base has industry standard 3" centers. Features snap-on, replaceable lens. Single wire design grounds through mounting hardware. All-weather molded plastic housing and durable lens to protect against corrosion.



PART#	DESCRIPTION	DIODES
OP-MCL55RB	Red light	3
OP-MCL55AB	Amber light	4
OP-A46PB	Plug, 6" lead	
OP-A55GB	Flush mount grommet	

2" Round sealed multiple diode LED marker/clearance lights. Features sonically sealed, waterproof lens and housing in a single unit. Accepts industry standard 2-prong plug for easy retrofit of incandescent lights. Requires mounting grommet and plug for complete installation. Also available in 12-24V variable voltage and 24V versions.

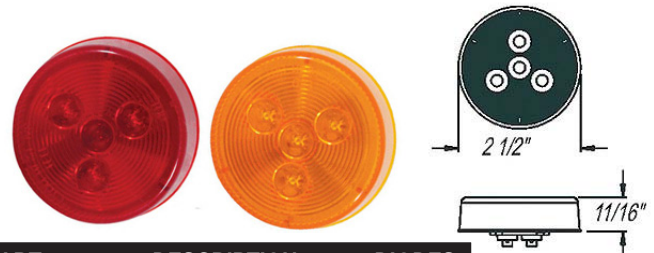

PART#	DESCRIPTION	DIODES
OP-MCL57RB	Red light	3
OP-MCL57AB	Amber light	4
OP-A46PB	Plug, 6" lead	
OP-A55GB	Flush mount grommet	

2-1/2" Round multiple diode LED clearance or side marker lights. Features sonically sealed, waterproof lens and housing in a single unit. Accepts industry standard 2-prong plug for easy retrofit of incandescent lights. Requires mounting grommet and plug for complete installation. Also available in 24V version.

PM PETERSON SIDE MARKER / CLEARANCE LIGHTS

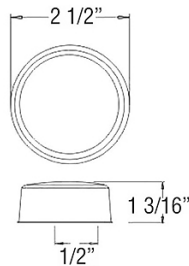

PART#	DESCRIPTION
OP-AL91AB	Amber light
OP-AL91RB	Red light
OP-A46PB	Plug, 6" lead
OP-A91GB	Grommet
OP-A91LW	12" Single wire lead
OP-A91OB	Chrome base, open back

PART#	DESCRIPTION
OP-MCL51AB	Amber light
OP-MCL51RB	Red light
OP-A46PB	Plug, 6" lead
OP-A55GB	Flush mount grommet

Miro-Flex™ 2-1/2" Round LED marker/clearance light. Faceted reflector design provides increased light output and a contemporary appearance while maintaining a traditional footprint. **3 diode** light features sonically sealed, waterproof lens and housing in a single unit. Accepts industry standard 2-prong plug for easy retrofit of incandescent lights. Requires mounting grommet and plug for complete installation.

Mini Thin Line **3 diode** sealed LED clearance or side marker light. Features sonically sealed, waterproof lens and housing in a single unit. Accepts industry standard 2-prong plug for easy retrofit of incandescent lights. Available as both individual unit and kit. Two-wire design contains both lead wire and ground wire for mounting to all surfaces. Multiple mounting and wiring options available.

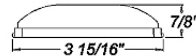
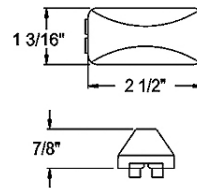

PART#	DESCRIPTION
OP-MCL75AB	Amber light
OP-MCL75RB	Red light
OP-A65PB	Black bracket & single wire plug

Thin Line **4 diode** sealed LED clearance or side marker light. Features sonically sealed, waterproof lens and housing in a single unit. Multi-diode design optimizes light output. Bracket mounts on industry standard 3" centers. Single wire design grounds through mounting hardware.

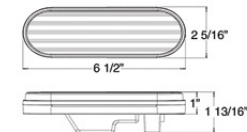

PART#	DESCRIPTION
OP-BUL52CB	Back-up light
OP-A70GB	Grommet
OP-A45CB	Straight pigtail
OP-A49PB	Right angle pigtail

6" Oval Sealed flush mount clear DOT LED back-up light. **36 diodes**. Meets DOT FMVSS 108 requirements in any 360° position. Features sonically sealed, waterproof lens and housing in a single unit. All-weather molded plastic housing and durable lens protect against corrosion. Accepts industry standard 2-prong plug for easy retrofit of incandescent lights. Requires mounting grommet and plug for complete installation. Certified for back-up light function when installed as pair in two-lamp system.

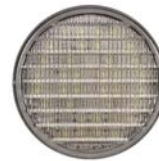

PART#	DESCRIPTION
OP-BUL53CB	Back-up light
OP-A45GB	Grommet
OP-A45CB	Straight pigtail
OP-A49PB	Right angle pigtail



4" Round sealed, flush mount, clear DOT LED back-up light. **36 diodes**. Meets DOT FMVSS 108 requirements in any 360° position. Features sonically sealed, waterproof lens and housing in a single unit. All-weather molded plastic housing and durable lens protect against corrosion. Accepts industry standard 2-prong plug for easy retrofit of incandescent lights. Requires mounting grommet and plug for complete installation. Certified for back-up light function when installed as pair in two-lamp system.

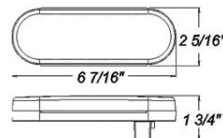

PART#	DESCRIPTION
OP-BUL72CB	Utility light
OP-A70GB	Grommet
OP-A45CB	Straight pigtail
OP-A49PB	Right angle pigtail

6" Oval sealed flush mount clear LED utility light. **10 super diodes** for bright, dependable performance. Polycarbonate lens is sonic welded to housing for durability. All-weather molded plastic housing and durable lens protect against corrosion. Accepts industry standard 2-prong plug for easy retrofit of incandescent lights. Requires mounting grommet and plug for complete installation. Not DOT approved.

IDENTIFICATION LIGHT BAR

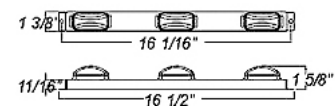

PART# OP-MCL93RB
Sealed 3-piece red LED identification light bar with three replaceable OP-AL91RB lights and 50" lead wire, for over 80" applications. **3 diodes per lamp**. Features sonically sealed, waterproof light capsules. Contains both lead wire and ground wire for mounting to all surfaces. Features all-weather molded plastic housing and durable lens to protect against corrosion.

SOLD INDIVIDUALLY

INCANDESCENT LIGHTING

F5



STOP, TURN AND TAIL LIGHTS



OPTRONICS	PETERSON	DESCRIPTION
	PM-426A	Amber light
OP-ST45RB	PM-426R	Red light
OP-ST44RB	PM-426KR	Red light kit
OP-A45GB	PM-426-18	Mounting grommet
OP-A45PB	PM-431-491	3-wire straight pigtail
OP-A45CB	PM-431-49	2-wire straight pigtail

Sealed, amber 4" round light functions as park & turn signal. Interchanges with all competitive models. Polycarbonate lens is welded to housing to form single unit. Requires mounting grommet and 2-wire plug to complete installation.

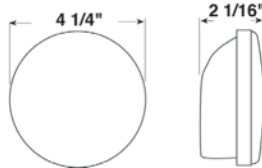

Sealed red 4" round stop/turn/tail light may be used on both curbside and roadside of vehicle or trailer. Polycarbonate lens is welded to housing to form single unit. Requires mounting grommet and 3-wire plug to complete installation. Kit includes light, grommet and straight plug.

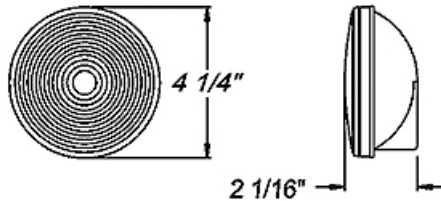

OPTRONICS	PETERSON	DESCRIPTION
OP-ST46RB	PM-427R	Red light
OP-A45GB	PM-426-18	Mounting grommet
OP-A45PB	PM-431-491	3-wire straight pigtail

4" Round sealed red stop/turn/tail light for flush mount. Includes reflector optics, allowing it to function as a rear reflector. Features sonically sealed, waterproof lens and housing in a single unit. Shock proof socket guarantees long bulb life. Accepts industry standard 3-prong plug. Available as both individual unit and kit. Requires mounting grommet and plug for complete installation.

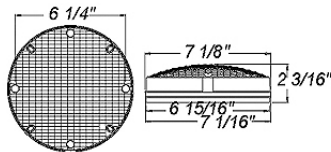

PART#	DESCRIPTION
OP-ST90RB	Red stop/tail light
OP-ST90AB	Amber turn signal

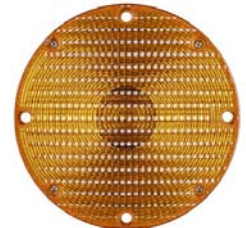

7" Round Bus and Transit Lights. **OP-ST90RB** is a red stop/tail light for surface mount. **OP-ST90AB** is an amber rear turn signal light for surface mount. Features gasket for weather-tight seal. Features screw-on, replaceable lens and easy to change replaceable bulb. Self grounding.



Sealed 6" oval amber parking/turn rear signal light meets DOT FMVSS 108 requirements in either horizontal or vertical mounting position. Polycarbonate lens is welded to housing to form single unit. Requires mounting grommet and 2-wire plug to complete installation.



Sealed 6" oval red stop/turn/tail light may be used on both curbside and roadside of vehicle or trailer. Legal in either horizontal or vertical position. Polycarbonate lens is welded to housing to form single unit. Requires mounting grommet and 3-wire plug to complete installation. Kit includes light, grommet and right angle plug.

OPTRONICS	PETERSON	DESCRIPTION
OP-ST70AB	PM-421A	Amber light
OP-ST70RB	PM-421R	Red light
OP-ST64RB	PM-421KR	Red light kit
OP-A70GB	PM-421-18	Mounting grommet
OP-A45PB	PM-431-491	3-wire straight pigtail
OP-A45CB	PM-431-49	2-wire straight pigtail
OP-A47PB	PM-421-491	3-wire right angle pigtail

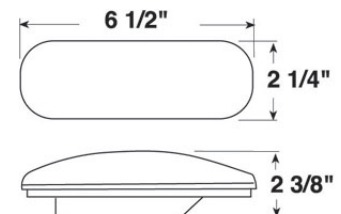

Toll Free: 800-922-6527 • Fax: 248-634-2022 • www.statewire.com

F6

INCANDESCENT LIGHTING

SOLD INDIVIDUALLY

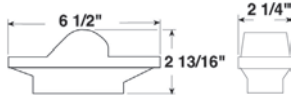

OPTRONICS	PETERSON	DESCRIPTION
OP-ST75AB	PM-352A	Amber light
OP-A70GB	PM-421-18	Mounting grommet
OP-A45CB	PM-431-49	2-wire straight pigtail
OP-A49PB	PM-421-49	2-wire right angle pigtail

Sealed 6" Oval Mid-Ship amber unit. Meets SAE recommended practice for side turn signal, while providing side marker light and side reflector functions. Popular model commonly referred to as a mid-turn light. Polycarbonate lens is welded to housing to form single unit. Grommet and plug are required to complete installation.

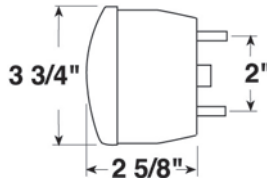

PART#	DESCRIPTION
PM-428	Red with license light
PM-428S	Red without license light

Universal stud-mount, combination tail light that functions as stop/turn/tail and license light. Features 3-3/4" diameter wrap-over lens retained by two screws, black plastic housing and two 10" lead wires. Mounts with two 1/4" studs on 2" centers. Grounds through mounting hardware.

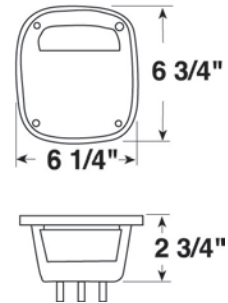

PART# PM-445

Universal stud-mount, combination tail light. Includes the following functions: stop/turn/tail/ back-up and license light. Features three 1/4" mounting studs with 2" triangular pattern. Includes molded housing and wire-loom harness with three lead wires.

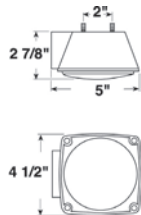

OPTRONICS	PETERSON	DESCRIPTION
OP-ST8RB	PM-440	Red without license light
OP-ST9RB	PM-440L	Red with license light
OP-A8RB	PM-440-15	Red tail light lens
OP-A9RB	PM-55-15R	Red side marker lens

Under-80" combination tail light. Includes the following functions: stop/turn/tail/rear reflex/side marker and side reflex. **OP-ST9RB & PM-440L** have all these functions plus license light. Mounts on 2" centers and includes mounting hardware. Grounds through 1/4" mounting studs.

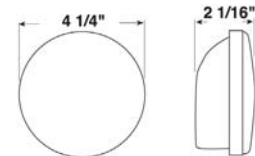

PART# PM-431R

4" sealed red stop/turn/tail light. Fully-automated manufacturing process for consistent quality and reliability. Features extra wide spin-welded, tongue and groove lens lip and waterproof seal. The high performance, copper alloy conductors eliminate the possibility of wire failure.



PART# PM-313-2RA

Pedestal-mount, double-face red/amber light functions as combination turn signal, parking light, or warning light. Durable black ABS housing with snap-on red and amber lenses. Two lead wires exit through 1/2" diameter mounting stud. Grounds through mounting stud. Popular style lamp is interchangeable with competitive units. Can be converted to single-face red or amber light by snapping on additional black back cover.

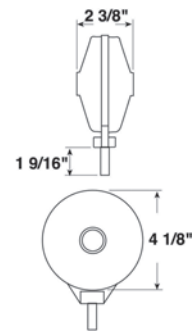

SOLD INDIVIDUALLY

INCANDESCENT LIGHTING

F7



MARKER / CLEARANCE LIGHTS

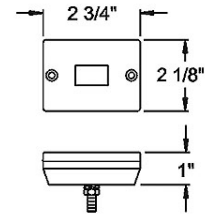
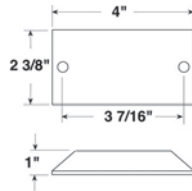

OPTRONICS	PETERSON	DESCRIPTION
OP-MC35AB	PM-115A	Amber light
OP-MC35RB	PM-115R	Red light

OPTRONICS	PETERSON	DESCRIPTION
OP-MC36AB	PM-114A	Amber light
OP-MC36RB	PM-114R	Red light

Surface mount light functions as side marker or clearance light with reflectorized lens. Mounts on 3-7/16" centers and grounds through mounting hardware. Single wire electric connection. Additional wire port is available for separate ground wire to mount on non-metallic surfaces. Peterson features the patented VIBAR® socket and 15,000-hour long-life bulb.

Stud mount clearance or side marker light with a reflectorized lens, eliminating the need for a separate reflector to meet DOT requirements. Single wire design grounds through mounting stud. Features replaceable lens and easy to change replaceable bulb. All-weather molded plastic housing and durable lens to protect against corrosion.

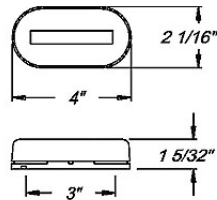

PART#	DESCRIPTION
OP-MC38AB	Amber light
OP-MC38RB	Red light

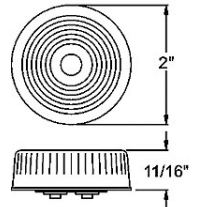

OPTRONICS	PETERSON	DESCRIPTION
OP-MC53AB	PM-146A	Amber light
OP-MC53RB	PM-146R	Red light
OP-A46PB	PM-142-49	Plug, 6" lead
OP-A54GB	PM-146-18	Flush mount grommet

Oblong clearance or side marker light with a reflectorized lens, eliminating the need for a separate reflector to meet DOT requirements. Features snap-on, replaceable lens and easy to change replaceable bulb. All-weather molded plastic housing and durable lens protect against corrosion. Mounts on industry standard 3" centers. Single wire design grounds through mounting hardware.

Sealed 2" round clearance or side marker light. **PC-Rated** light functions as both a clearance and side marker light when properly mounted on a 45° angle. Features sonically sealed, waterproof lens and housing in a single unit. Accepts industry standard 2-prong plug. Requires mounting grommet and plug for complete installation.

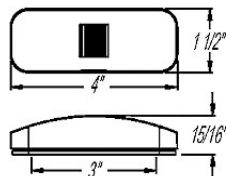

PART# OP-MC44AB

Rectangular clearance or side marker light with reflectorized lens, eliminating the need for a separate reflector to meet DOT requirements. Features snap-on, replaceable lens and easy to change replaceable bulb. All-weather molded plastic housing and durable lens protect against corrosion. Mounts on industry standard 3" centers. Assembly contains both lead and ground wire for mounting to all surfaces.

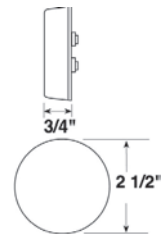
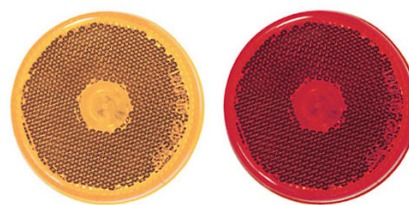

OPTRONICS	PETERSON	DESCRIPTION
OP-MC57AB	PM-143A	Amber light
OP-MC57RB	PM-143R	Red Light
OP-A46PB	PM-142-49	Plug, 6" lead
OP-A55GB	PM-142-18	Flush mount grommet

Round sealed 2-1/2" clearance or side marker light with reflectorized lens, eliminating the need for a separate reflector to meet DOT requirements. Features sonically sealed, waterproof lens and housing in a single unit. Accepts industry standard 2-prong plug. Requires mounting grommet and plug for complete installation.

F8

INCANDESCENT LIGHTING

SOLD INDIVIDUALLY

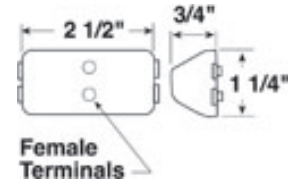
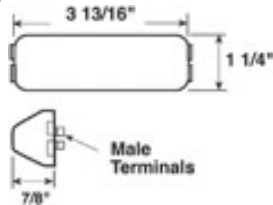

OPTRONICS	PETERSON	DESCRIPTION
OP-MC65AB	PM-154A	Amber light
OP-MC65RB	PM-154R	Red Light
OP-A65PB		Black mounting bracket kit
	PM-154-09K	Gray mounting bracket kit
	PM-154KA	PM-154A & PM-154-09K
	PM-154KR	PM-154R & PM-154-09K

OPTRONICS	PETERSON	DESCRIPTION
OP-A91AB	PM-150A	Amber light
OP-A91RB	PM-150R	Red Light
OP-A46PB	PM-142-49	Plug, 6" lead
OP-A91GB	PM-150-18	Mounting grommet

Functions as side marker or clearance light. When mounted at a 45° angle, light may be used as combination clearance and side marker. Lens is welded to housing to form single unit. Mounting bracket and electrical connector required. Mounting screw serves as ground when mounted to metallic surface with single lead wire for electrical connection. Series has male pins. Features two 15,000-hour long life bulbs. Kits include light and mounting bracket with lead wire.

Functions as side marker or clearance light and may be used as a combination clearance and side marker when properly mounted. Lens is welded to housing to form a single unit. Features 15,000-hour long life bulb and female terminals. Mounting bracket and electrical connector required to complete installation.

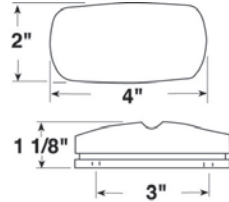

OPTRONICS	PETERSON	DESCRIPTION
OP-MC42AB	PM-138A	Amber light
OP-MC42RB	PM-138R	Red light
	PM-138-15A	Amber Replacement Lens
	PM-138-15R	Red Replacement Lens

Popular two-bulb lamp that functions as clearance or side marker light, and may be used as combination clearance and side marker when properly mounted. Acrylic lens snaps onto housing. Surface mounts on 3" centers and grounds through mounting hardware; single wire for electrical connection. Features two 15,000-hour long life bulbs. Optronics lights come with a black base and Peterson lights have a white base.

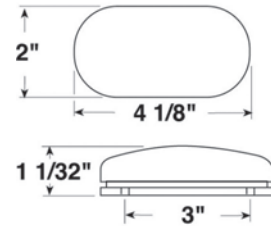

PART#	DESCRIPTION
PM-135A	Amber light
PM-135R	Red light
PM-134-15A	Amber Replacement Lens
PM-134-15R	Red Replacement Lens

Oblong clearance or side marker light. When properly mounted, may be used as combination side marker and clearance light. Acrylic lens snaps onto housing. Surface mounts on 3" centers. Single wire connection, grounds through mounting hardware. 15,000-hour long life bulb.

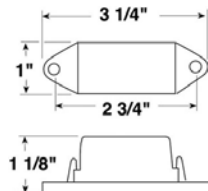

PART# PM-107WA

Amber mini lite unit functions as clearance, side marker or identification light and may be used as combination side marker and clearance light when properly mounted. Features durable base with external mounting holes. Lens snap-locks onto base. Available in red also.



PART# PM-56-15R

Over 80" Clearance / Side Marker red, replacement lens. Fits Peterson 444, 444L, 452 & 452L series lights.

SOLD INDIVIDUALLY

INCANDESCENT LIGHTING

F9

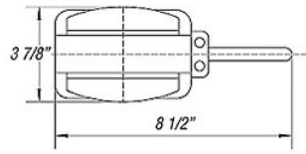

PART#	DESCRIPTION
OP-BA44FNL	Left side light
OP-BA44FNR	Right side light

Pre-wired fender light assembly. Functions as both amber front clearance light and red rear clearance light for over 80" applications. Features a reflectorized lens, eliminating the need for a separate reflector to meet DOT requirements. Mount on top or side of most fenders to mark widest point on trailer. Assembly contains OP-MC44AB and OP-MC44RB lights and fender-mount bracket.

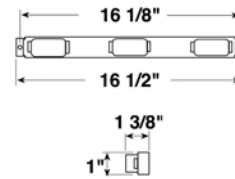

OPTRONICS	PETERSON	DESCRIPTION
OP-MC99RB	PM-107-3R	Red lightbar

Economical identification bar light for over 80" applications. Corrosion-resistant bar is powder-coated white with three lights attached. Mounts on 16-1/8" centers and grounds through mounting hardware.

BACK-UP & UTILITY LIGHTS

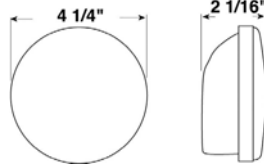

PART#	DESCRIPTION
PM-415	Back-Up light
PM-426-18	Black round grommet
PM-431-49	Straight plug, 10-1/2"

Sealed 4" round clear light that functions as back-up or utility light. Fully automated manufacturing process ensures consistent quality and reliability. Features extra wide, spin-welded, tongue and groove lens lip and waterproof seal. High performance, copper alloy conductors eliminate the possibility of wire failure. State-of-the-art bulb design features three supports for the minor filament and two supports for the major filament providing long bulb life. Wedge-base socket prevents premature bulb failure. Requires mounting grommet and 2-wire plug.

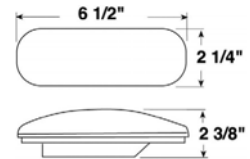

PART#	DESCRIPTION
PM-416	Back-Up light
PM-421-18	Black oval grommet
PM-421-49	Right angle plug, 10-1/2"

Sealed clear oval back-up light meets DOT requirement in either horizontal or vertical position. Polycarbonate lens is sonic welded to housing to form single unit. Requires mounting grommet and 2-wire plug to complete installations.

TRACTOR IMPLEMENT LIGHTS

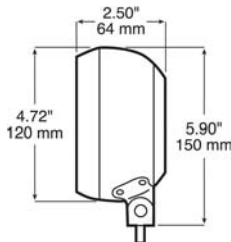

PART# PM-507
Rubber molded housing cushions a flush-mount, PAR 36 trapezoid sealed beam from shock and vibration. Universal 5/16" mounting stud and adjustable zinc-plated bracket allow mounting in any position. 10" lead wire exits through back of housing. Also available in flood beam patterns. **Used on salting trucks.**

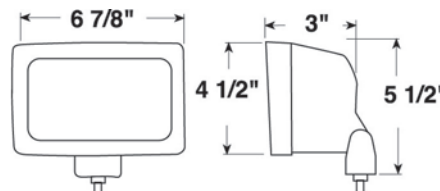

PART# PM-V504HF
Heavy-duty flood lamp with 4" x 6" lens functions as tractor or general work light. Features H3 55-watt halogen replaceable bulb, polycarbonate housing and black-plated mounting bracket for corrosion-free service. Also available in trapezoid patterns.



Toll Free: 800-922-6527 • Fax: 248-634-2022 • www.statewire.com

F10

INCANDESCENT LIGHTING

SOLD INDIVIDUALLY



LICENSE PLATE LIGHTS

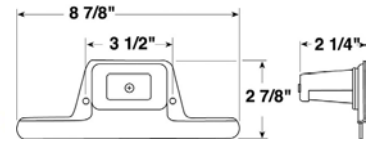
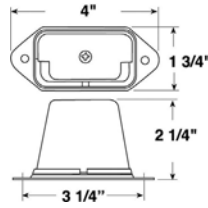

Clear license plate light. Features tough polycarbonate lens and ABS hood. All internal parts are durable stainless steel or tinned-brass. **PM-436 / OP-LP51CB** surface mounts on 3-1/4" centers. **PM-436B / OP-LP52CB** includes a black powder-coated, steel license plate bracket riveted to light. Surface mounts on 3-1/2" centers.

OPTRONICS	PETERSON	DESCRIPTION
OP-LP51CB	PM-436	License Plate Light
OP-LP52CB	PM-436B	License Plate Light with bracket

PART#	DESCRIPTION
PM-439	License plate light
PM-142-49	Plug, 6" leads

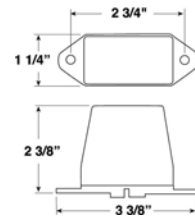

Clear sealed surface mount license light. Polycarbonate lens and housing are sonic welded for watertight seal. Mounts on 2-3/4" centers. Requires plug for electrical connection.

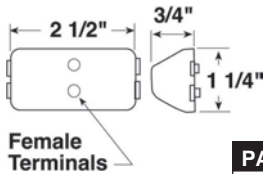

PART#	DESCRIPTION
PM-150C	License plate light
PM-150-141	Black bracket
PM-142-49	Plug, 6" leads

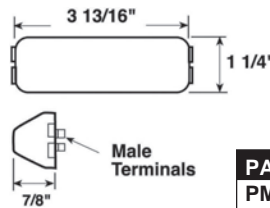

PART#	DESCRIPTION
PM-154C	License plate light
PM-154-09K	ABS mounting bracket kit

High impact resistant lens and housing are welded into single unit for maximum protection. Side of lens painted to meet license illuminator requirements. Requires mounting bracket and plug to complete installation.

Polycarbonate lens and housing welded into single unit for maximum protection. Same quality features as PM-150C in two bulb design. Requires mounting bracket kit to complete installation.

ACCESSORIES

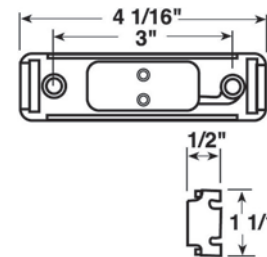

OPTRONICS	PETERSON	DESCRIPTION
OP-A65PB	PM-154-09K	ABS mounting bracket kit, Gray
	PM-154-11K	ABS mounting bracket kit, Black

Allows Peterson 154 and 161 series and Optronics MC-65/67 lights to be surface mounted. Mounts on 3" centers. Kit mounts on metal surfaces and includes bracket, terminal pad with molded lead wire and mounting screws. Grounds through mounting hardware. Gray, chrome or black finish.

SOLD INDIVIDUALLY

LIGHTING ACCESSORIES

F11



PLUGS AND PIGTAILS



3-Wire Straight Pigtail



3-Wire Right Angle Pigtail

3-wire molded plugs for double contact sealed stop/turn/tail lamps. Includes #10 ring terminal on ground wire; hot wire is stripped. Available with straight or right angle plug.

OPTRONICS	PETERSON	DESCRIPTION
OP-A45PB	PM-431-491	3-Wire Straight Pigtail
OP-A47PB	PM-421-491	3-Wire Right Angle Pigtail



2-Wire Straight Pigtail



2-Wire Right Angle Pigtail

2-wire molded plugs for single contact sealed stop/turn or backup lamps. Includes #10 ring terminal on ground wire; hot wire is stripped. Available with straight or right angle plug.

OPTRONICS	PETERSON	DESCRIPTION
OP-A45CB	PM-431-49	2-Wire Straight Pigtail
OP-A49PB	PM-421-49	2-Wire Right Angle Pigtail



OP-A46PB



PM-142-49

OPTRONICS	PETERSON	DESCRIPTION
OP-A46PB	PM-142-49	2-Wire pigtail, 6" lead

2-wire molded plug for clearance and marker lights. Fits Peterson lights 142, 143, 145, 146, 150 series and Optronics MC-53, MC-57AB and RB clearance and marker lights, and all competitive models. Includes a #10 ring terminal on ground wire; hot wire is stripped.



PART# PM-150-49
Replacement wire harness for Peterson 150-3 series identification light bar. Fits all competitive models. 6" ground wire w/ring terminal and 8" hot wire. Includes #10 ring terminal on ground wire; hot wire is stripped. May be used as harness individual corner or ID lights.

PART# GR-01-6868-82
OEM replacement pigtail for the "Ford OEM Box Lamps" (Ford #F4HZ-13405-BA-LH & #F4HZ-13404-A-RH), Grote Part# GR-53780 & GR-53792



GROMMETS

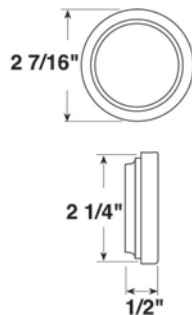

OPTRONICS	PETERSON	DESCRIPTION
OP-A54GB	PM-146-18	2" Flush Mount Grommet

Allows 2" diameter sealed units to be flush mounted. Requires two 5/16" mounting hole and plug to complete installation. Fits Peterson 145, 146, 164, 165, 166 and Optronics MC-53AB/RB series lights.

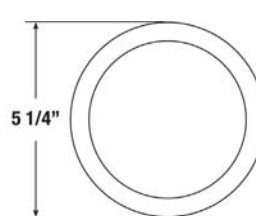

OPTRONICS	PETERSON	DESCRIPTION
OP-A45GB	PM-426-18	4" Flush Mount Grommet

Black PVC grommet flush mounts 4" diameter round style lamps in 4-1/2" hole. May be used with Peterson 415, 417, 426, or 427 and Optronics ST-45RB or BU-45CB series round stop/turn/ tail and back-up lights. Provides additional shock absorbency to extend lamp life.

Toll Free: 800-922-6527 • Fax: 248-634-2022 • www.statewire.com



GROMMETS

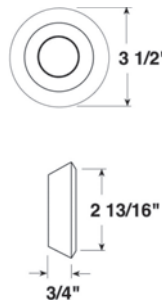
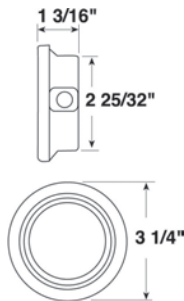

PART# PM-143-18

Allows 2-1/2" diameter sealed units to be recess mounted. Requires 2-25/32" mounting hole and plug to complete installation. Fits Peterson 142, 143, 162, and 163 series lights.

OPTRONICS	PETERSON	DESCRIPTION
OP-A55GB	PM-142-18	2-1/2" Flush Mount Grommet

Allows 2-1/2" diameter sealed units to be flush mounted. Requires 3" mounting hole and plug to complete installation. Open back. Fits Peterson 142, 143, 162, 163 and Optronics MC-55 and MC-57 series lights.

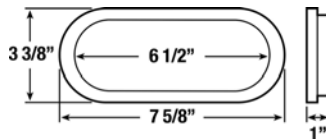

OPTRONICS	PETERSON	DESCRIPTION
OP-A70GB	PM-421-18	Oval Grommet

Black PVC grommet flush mounts oval style lamps. May be used with Peterson 350, 352, 416, 420, or 421 and Optronics ST-70AB/RB and BU-70CB series oval lights and with other similar competitors lights. Provides additional shock absorbency to extend lamp life.

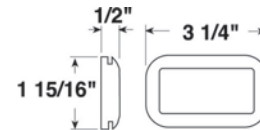

OPTRONICS	PETERSON	DESCRIPTION
OP-A91GB	PM-150-18	Mounting Grommet

Black grommets used to flush mount Peterson 150, 152 and 153 and Optronics A-91AB/RB series light on metallic and non-metallic surfaces.

BRACKETS

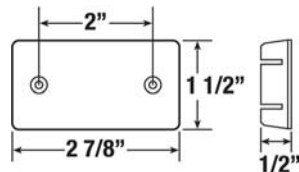

PART# PM-150-09

Allows Peterson 150 or 152 series to be surface mounted. Gray finish. Mounts on 2" centers. Requires 2-wire plug for electrical connection. Pack includes bracket, gasket and mounting screws.

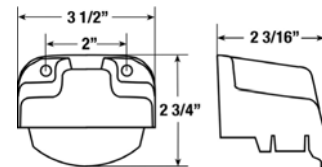

PART# PM-150-141

Black License/Utility light bracket. High-impact polycarbonate. Peterson 150 & 153 series lamp clamps into housing to form single unit. Use PM-150C or PM-153C LED light for license light application.

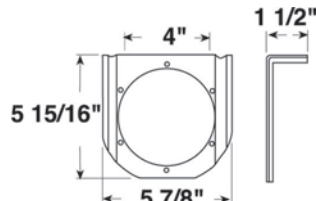

OPTRONICS	PETERSON	DESCRIPTION
OP-BK45BB	PM-426-09	4" Round Mounting Bracket

4" Round mounting bracket. Black powder-coated steel. Fits all grommet-mounted and most flange-mounted 4" diameter lamps. May be bolted or welded in place. Use PM-426-18 or OP-A45GB to complete grommet installation.

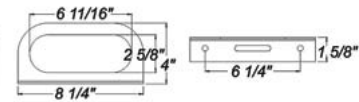

PART#OP-BK70BB

Black powder-coated steel bracket for horizontal or vertical mounting of 6" oval lights. OP-A70GB required to complete grommet installation.

SOLD INDIVIDUALLY

LIGHTS, BRACKETS & MIRRORS F13



BRACKETS

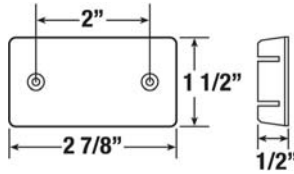

PART#	DESCRIPTION
PM-150-092	Black bracket kit
PM-150-102	Chrome bracket kit

Chassis mounting kits. Allows Peterson 150 series lights to be surface mounted. Available in chrome and black. Mounts on 2" centers. Grounds through mounting hardware. Kit includes bracket, gasket, mounting screws and 17" lead wire with .156 bullet terminal.

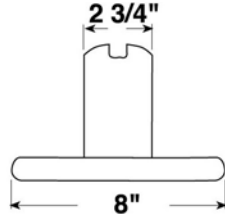

PART# PM-440-09

Black plastic universal license bracket. For use with most PM stud-mounted tail lights. Corrosion-free black plastic which flexes on impact.

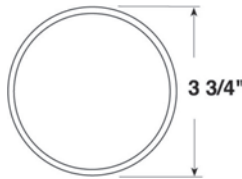

MIRRORS

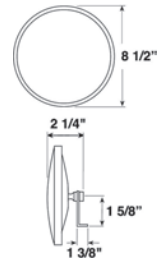

PART# PM-603L

3-3/4" diameter convex glass mirror in molded, black, corrosion-free housing. Weather-resistant adhesive back permanently installs to any clean flat surface.

PART# PM-608

8" diameter convex glass mirror. Adjustable ball stud with 5/16" internal thread. Includes bright plated right angle bracket. Durable black enamel finish.

TOWING LIGHTS

PART# LTKT-TOW

Magnet-mount towing light kit with 20-ft. trailer wiring harness plugs into standard 4-wire flat vehicle connector. 12 volt Towing Lights easily connect to any standard automobile lighting system in minutes. Visible up to one mile. Exceeds Department of Transportation highway standards. DOT FMVSS 108 compliant. Standard features include a powerful non-scratch **magnetic base**, 5 feet of wire light to light, 20 feet trailer harness, 4 foot 4-wire vehicle connector and easy-to-use directions.



SUBMERSIBLE LOW PROFILE TAIL LIGHTS



WB-403026



WB-403076



WB-403348

PART#	DESCRIPTION
WB-403026	8-Way Tail Light (LH)
WB-403076	7-Way Tail Light (RH)
WB-403336	Replacement Lens Set
WB-403348	Replacement Capsule

Over 80 Tail lights are designed for both low profile custom boat trailers and snowmobile trailers. These versatile submersible units serve seven basic functions: tail light, stop light, turn signal, side and rear (red) reflex reflector, red side marker light and red rear clearance light. The built-in rear clearance light is a real plus! Featuring a reliable waterproof design, these lights have a bulb replaceable capsule that protects the bulbs from corrosion and thermal shock but still allows for easy access for bulb replacement. These lights meet FMVSS/CMVSS 108 requirements for trailers over 80" wide when properly mounted. Pre-installed 15" pigtails make wiring both fast and simple. Wesbar flexibility allows these lights to be flush or recessed mounted. Left hand model has built-in license plate illuminator. Matte black finish. Overall dimensions: 8"L x 2-7/8"H x 2-3/4"D

Toll Free: 800-922-6527 • Fax: 248-634-2022 • www.statewire.com



SNOWMOBILE TRAILER LIGHTS KIT

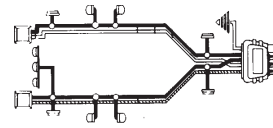
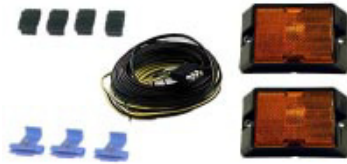

PART# GR-65300-2

Wrap-around tail lamp for utility and snowmobile trailers. Unique compact mounting snugs as if custom made into standard C-channels. 5-in-1 functions: stop, tail, turn, side marker and reflector. Long-life Duramold body in white. Kit comes complete with 24' wiring harness, mounting hardware and two combination side marker/reflector lamps. 20' trailer side, 4' vehicle side plus frame clips, directions and wire connectors.

REPLACEMENT PARTS	
PART#	DESCRIPTION
GR-52362-3	Left-side 5-function tail light
GR-52372-3	Right-side 5-function tail light
GR-92382-3	Face lens
GR-92392-3	Side lens
PM-115A	Side marker lights
TH-24Y	Trailer harness (5 Wires, 4 Pin)



TRAILER HARNESS KITS

"Y" type Male (Trailer End) (5 Wire).
4 foot Female (Vehicle End).
Complete with instructions and mounting hardware.

PART#	DESCRIPTION
TH-24Y	With 20' male trailer & 4' female vehicle
TH-29Y	With 25' male trailer & 4' female vehicle
REPLACEMENT PARTS	
4WFF-48	4 foot female vehicle
4WFM-20Y	20 foot "Y" male (5 Wire, 4 Pin) trailer
4WFM-25Y	25 foot "Y" male (5 Wire, 4 Pin) trailer
FCM	Frame clips
SL-W3M	Scotchloc in-line connectors

STANDARD TRAILER LIGHTING KITS



Combination lights perform seven functions: stop/turn/tail, rear reflector, side marker light and reflector, and license illuminator. Molded housings will never corrode. Kits available in 2 different combinations to fit your every need. **Packaged for display.**

OPTRONICS PART#	PETERSON PART#	DESCRIPTION
OP-LTKT	LTKT	Pair of tail lights and plastic license plate bracket
OP-LTKT-C	LTKT-C	Contains all of the above PLUS a complete wiring harness and running lights.
REPLACEMENT PARTS		
OP-ST8RB	PM-440	6-function tail light
OP-ST9RB	PM-440L	7-function tail light with license illuminator
OP-LP5SB	PM-440-09	Plastic License plate bracket
OP-MC35AB	PM-115A	Amber side marker light
TH-24Y	TH-24Y	20 foot wiring harness (5 Wires) and 4 foot vehicle connector.

BLADELIGHTS™ SNOW PLOW AND AUXILIARY LIGHT KIT

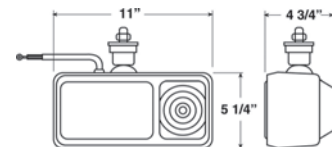

PART# PM-505K

Functions as head light and turn signal for snow removal vehicles. Features low-profile housing and halogen sealed beam. Mounts with 1/2" diameter, adjustable-ball stud. Meets FMVSS108 requirements. Easy-to-replace sealed halogen beam and turn signal bulb. Kits include two lights, wiring, switch, mounting hardware, and easy-to-follow instructions. Packaged in bright, four-color display box. Replacement seal beam W-H6545 and turn signal light bulbs W-2357.

SOLD INDIVIDUALLY

EMERGENCY LIGHTING

F15

STROBING LIGHTS

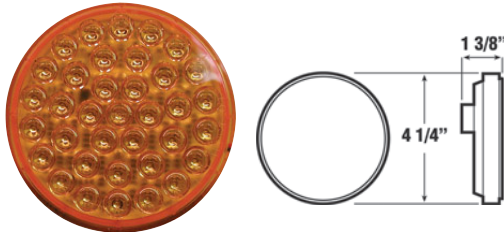

PART#	DESCRIPTION
PM-417SA-1	Amber LED Strobe Light Synchronous flash pattern
PM-417SA-2	Amber LED Strobe Light Alternating flash pattern
PM-426-18	Mounting Grommet
PM-417-49	3-wire Plug

Round 4" Piranha® LED strobing light that may be used as auxiliary strobe or warning light. Offers triple-flash function and operates from 9-32 volts. Compatible with any 12 or 24 volt system. **No separate flasher unit or strobe controller required.** Available with random, synchronous or alternating flash patterns. Meets SAE J1318 and J845 specifications in horizontal, vertical or any 360° position. New hard-wired design eliminates need for separate plug. Larger weld area for stronger, watertight seal.

PART#	DESCRIPTION
PM-420SA-1	Amber LED Strobe Light Synchronous flash pattern
PM-420SA-2	Amber LED Strobe Light Alternating flash pattern
PM-421-18	Mounting Grommet
PM-417-49	3-wire Plug

Oval Piranha®, LED strobing light that may be used as auxiliary strobe or warning light. Offers triple-flash function and operates from 9-32 volts. Compatible with any 12 or 24 volt system. **No separate flasher unit or strobe controller required.** Available with random, synchronous or alternating flash patterns. Meets SAE J1318 and J845 specifications in horizontal, vertical or any 360° position. New hard-wired design eliminates need for separate plug. Larger weld area for stronger, watertight seal.

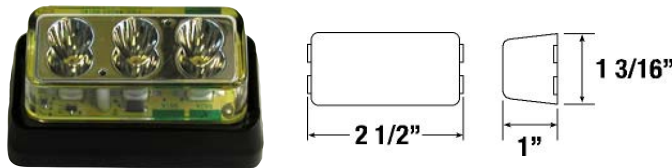

PART#	DESCRIPTION
PM-153SA-1	Amber LED Strobe Light Synchronous flash pattern
PM-153SA-2	Amber LED Strobe Light Alternating flash pattern
PM-150-18	Mounting Grommet
PM-150-09	Mounting Bracket

Piranha® LED Ultra-Mini Strobing Light has triple flash. Ultra-compact size allows installation on nearly any vertical surface. Passes J845 Class 1 and J1318 Class 1 specs. 60 triple flashes per minute. Alternating or Synchronous flash patterns. 9-16 volt operating range. Individual parabolic reflectors direct and focus strobe flash from each of six high-output diodes for maximum brightness. Features a long-lasting, solid state design with low amp draw. Hard-wired design eliminates the need for separate plug and reduces connection points. Surface mounting for quick and easy installation. Requires mounting bracket or grommet for installation. **No separate flasher unit or strobe controller required.**



PERMANENT MOUNT



MAGNET MOUNT

ECONOMY LOW PROFILE 17" LED STROBE LIGHTBAR

12-24V Economy low-profile LED light bar. 2-3/4" tall. Draws 1.4 Amps. Cycles thru 3 pre-programmed flash patterns. Magnet mount includes 15' straight cord and plug with built in ON/OFF switch and LED indicator light.

PART#	DESCRIPTION	COLOR
NA-MMBSLEDFLP-C/A	Permanent Mount	Amber
NA-MMBSLEDFLP-C/R	Permanent Mount	Red
NA-MMBSLEDFLM-C/A	Magnet Mount	Amber
NA-MMBSLEDFLM-C/R	Magnet Mount	Red

LED WARNING LIGHT

PART# NA-LED625-A

High impact LED Warning light with a complete 360° Display. Low current draw. Flash pattern can be changed with button on base of light. There are four (4) user-selectable patterns. 12-24V DC. Flange Base.



Toll Free: 800-922-6527 • Fax: 248-634-2022 • www.statewire.com

F16

EMERGENCY LIGHTING

SOLD INDIVIDUALLY

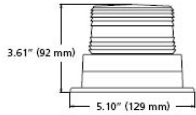

THE FIREBOLT STROBE offers the dependability of a strobe at a revolving light price. Modular construction incorporates a powerful integral flash tube and vibration-resistant circuit board. The unit also features a tough impact-resistant polycarbonate lens and base. Applications include forklifts, electric vehicles, industrial trucks and equipment. Supplied with enclosed base and all necessary mounting hardware. **THE FIREBOLT PLUS STROBE** offers all the features and specifications of the FIREBOLT Strobe except it has a **replaceable flash tube** and protection against voltage spikes and reverse polarity. **Both meet SAE J1318 requirements for Class 3. Three year circuitry warranty. Replacement flash tube warranty is 6 months.**

PART#	DESCRIPTION	HEIGHT	DIA	VOLTS	JOULES	FLASH
TT-220100-02	Firebolt	3-5/8	5	12 to 72	2	Single
TT-220200-02	Firebolt Plus	3-5/8	5	12 to 72	2	Single
TT-211300	Replacement Flash Tube					

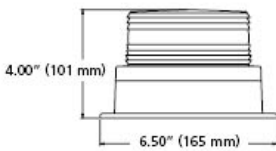

PULSATOR® 451 HEAVY DUTY STROBES feature an advanced RTV **silicone gel compound that hermetically seals the power supply**. This unique temperature-resistant compound seals against moisture and dirt and effectively dampens severe shock and vibration. Ideal for severe service applications that require shock, vibration and water-resistant performance. Patented polycarbonate base design and O-ring seal combined with a convenient screw on/off lens for simple flash tube replacement. **Meets SAE J1318 requirements for Class 2. Three year circuitry warranty. Replacement flash tube warranty is 6 months.**

PART#	DESCRIPTION	HEIGHT	DIA	VOLTS	JOULES	FLASH
TT-211823-02	451 Pulsator®	4	6-1/2	12 to 48	10	Double
TT-439411	Replacement Flash Tube					

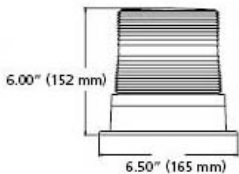

PULSATOR® 551 HEAVY DUTY STROBES feature an advanced RTV **silicone gel compound that hermetically seals the power supply**. This unique temperature-resistant compound seals against moisture and dirt and effectively dampens severe shock and vibration. Ideal for severe service applications that require shock, vibration and water-resistant performance. Patented polycarbonate base design and O-ring seal combined with a convenient screw on/off lens for simple flash tube replacement. **Meets SAE J1318 requirements for Class 2. Three year circuitry warranty. Replacement flash tube warranty is 6 months.**

PART#	DESCRIPTION	HEIGHT	DIA	VOLTS	JOULES	FLASH
TT-211832-02	551 Pulsator®	6-1/2	6-1/2	12 to 48	8	Double
TT-211832-03	551 Pulsator®	6-1/2	6-1/2	12 to 48	8	Double
TT-211820-02	551 Pulsator®	6-1/2	6-1/2	12 to 48	10	Double
TT-439290	Replacement Flash Tube					

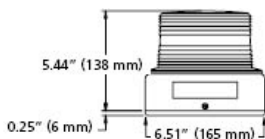

MODEL 651 STROBES features include helical flash tube and polycarbonate lens for maximum light emission. Supplied with corrosion-resistant anodized aluminum open bases. Includes flexible rubber gasket for vehicle protection and all necessary hardware (mounts with two bolts). **Meets SAE J1318 requirements for Class 2, AAMVA certified. Five year circuitry warranty. Replacement flash tube warranty is 6 months.**

PART#	DESCRIPTION	HEIGHT	DIA	VOLTS	JOULES	FLASH
TT-420200-02	Model 651	5-3/4	6-5/8	12 to 48	12	Double
TT-211200	Replacement Flash Tube					

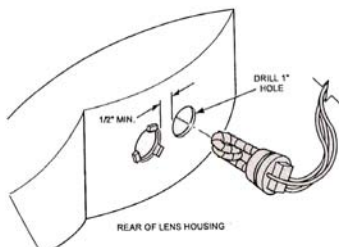

PART# TT-413201-05

Corner strobe tube with AMP Plug. Clear. Includes male and female connectors for optional connections. Also available with weatherpack connection (TT-413300-05). Requires separate power supply (not included).

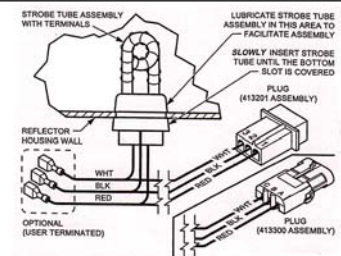

Lens Color: -02=Amber -03=Blue -04=Red -05=Clear -06=Green -07=Purple

State Wire and Terminal, Inc.

QUICK INDEX SECTION G

G1

Kits / Assortments / Storage Systems

- | | | | |
|---------------|--|------------|---|
| G2 | GM Assortments | G13 | Plastic Grommet Kit, Rubber Grommet Kit and Solder Slug Kit |
| G3 | Deutsch Connector and Insulated Connector Kit | G14 | Roll Pin Assortment, Hose Clamp Assortment and Magnetic Chuck Drive Kit |
| G4 | Shrink Tube Kits and Shrink Tube Terminal Kits | G15 | Grease Fitting Kit, Vacuum Hose Connector Assortment, Aluminum Blind Rivet Assortment and Storage Systems |
| G5 | Fuse Kit and Copper Battery Lug Kit | G16 | Storage Systems |
| G6-7 | Brass Fitting Kit and Nylon Ties Assortments | | |
| G8-9 | Nut and Bolt Assortments | | |
| G10-11 | Screw Assortments | | |
| G12 | Cotter Pin Kit, Hitch Pin Kit, Insulated Metal Clamp Kit and Wire Caddy Assortment | | |



G2



G11

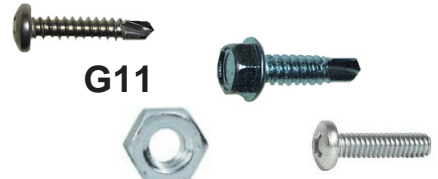

G3



G12



G4



G13



G5



G14



G6-7



G15



G8-9



G16



G10





PACK-CON METRI-PACK 150 METRI-PACK 280 METRI-PACK 630



WEATHER PACK 20-18 GA WEATHER PACK 16-14 GA WEATHER PACK 12 GA



1 CAVITY MALE SHELL 2 CAVITY MALE SHELL 3 CAVITY MALE SHELL 4 CAVITY MALE SHELL 6 CAVITY MALE SHELL



1 CAVITY FEMALE SHELL 2 CAVITY FEMALE SHELL 3 CAVITY FEMALE SHELL 4 CAVITY FEMALE SHELL 6 CAVITY FEMALE SHELL

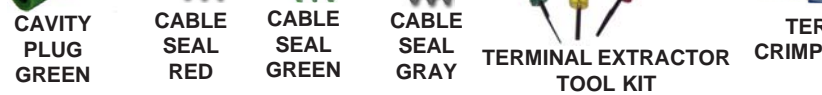

CAVITY PLUG GREEN CABLE SEAL RED CABLE SEAL GREEN CABLE SEAL GRAY TERMINAL EXTRACTOR TOOL KIT



TERMINAL CRIMPING TOOL



PART# GM-KIT190
190 piece kit containing the most popular sizes of Weather Pack and Metri-Pack connectors. These are housed in a 12-compartment plastic storage box. **BX-PL12**

PART# GM-KIT300
300 piece kit with the most popular sizes of GM Weather Pack terminals and connectors. These are housed in a sturdy 21-compartment metal storage box. **BX-ML21**

FOR MORE INFORMATION ON GM TERMINALS SEE PAGES A12 AND A13

PART#	SERIES TYPE	DESCRIPTION TERMINAL STYLE	BLADE SIZE	WIRE GAUGE	WIRE GA MM	KIT#	
						GM-KIT190	GM-KIT300
GM-06294511	Pack-Con	Male Blade	3.75 MM	20-18	.5 - .8	10	
GM-12020346	Pack-Con	Female		20-18	.5 - .8	10	
GM-12020320	Pack-Con	Male Blade	3.75 MM	16-14	1.0 - 2.0	10	
GM-12020347	Pack-Con	Female		16-14	1.0 - 2.0	10	
GM-12047581	Metri-Pack 150	Male Blade	1.5 MM	20-18	.5 - .8	10	
GM-12047767	Metri-Pack 150	Female		20-16	.5 - 1.0	10	
GM-12020116	Metri-Pack 280	Male Blade	2.8 MM	16-14	1.0 - 2.0	10	
GM-12066214	Metri-Pack 280	Female		16-14	1.0 - 2.0	10	
GM-12020126	Metri-Pack 630	Male Blade	6.3 MM	16-14	1.0 - 2.0	10	
GM-12015870	Metri-Pack 630	Female		16-14	1.0 - 2.0	10	
GM-12089040	Weather Pack	Male Pin		20-18	.5 - .8	10	25
GM-12089188	Weather Pack	Female		20-18	.5 - .8	10	25
GM-12124582	Weather Pack	Male Pin		16-14	1.0 - 2.0	10	25
GM-12124580	Weather Pack	Female		16-14	1.0 - 2.0	10	25
GM-12124587	Weather Pack	Male Pin		12	3.0		25
GM-12124581	Weather Pack	Female		12	3.0		25
GM-12015791	Weather Pack	1 Cavity Male Shell				5	5
GM-12010996	Weather Pack	1 Cavity Female Shell				5	5
GM-12015792	Weather Pack	2 Cavity Male Shell				5	5
GM-12010973	Weather Pack	2 Cavity Female Shell				5	5
GM-12015793	Weather Pack	3 Cavity Male Shell				5	5
GM-12010717	Weather Pack	3 Cavity Female Shell				5	5
GM-12015797	Weather Pack	4 Cavity Male Shell					5
GM-12010974	Weather Pack	4 Cavity Female Shell					5
GM-12015799	Weather Pack	6 Cavity Male Shell					5
GM-12010975	Weather Pack	6 Cavity Female Shell					5
GM-12010300	Weather Pack	Cavity Plug - Green				10	25
GM-15324983	Weather Pack	Cable Seal - Red		18	.8		25
GM-12015323	Weather Pack	Cable Seal - Green		16-14	1.0 - 2.0	10	25
GM-15324980	Weather Pack	Cable Seal - Gray		12	3.0		25
GM-0660T		Terminal Extractor Tool Kit					1
AVC-16004		Terminal Crimping Tool					1

SOLD INDIVIDUALLY

TERMINAL ASSORTMENTS

G3

DEUTSCH CONNECTOR ASSORTMENT



PART# DE-KIT142

142 pieces of Deutsch connectors, terminals and a contact removal tool. The diagram on the inside cover of the kit allows easy identification. These are stored in a 32-compartment metal storage box. **BX-ML32.**

PART#	DESCRIPTION	QTY
DE-DT04-2P	2-Contact Socket Receptacle	2
DE-DT04-3P	3-Contact Socket Receptacle	2
DE-DT04-4P	4-Contact Socket Receptacle	2
DE-DT04-6P	6-Contact Socket Receptacle	2
DE-DT04-12PA	12-Contact Socket Receptacle	1
DE-DT06-2S	2-Contact Plug Receptacle	2
DE-DT06-3S	3-Contact Plug Receptacle	2
DE-DT06-4S	4-Contact Plug Receptacle	2
DE-DT06-6S	6-Contact Plug Receptacle	2
DE-DT06-12SA	12-Contact Plug Receptacle	1
DE-W2P	2-Contact Socket Lock	2
DE-W3P	3-Contact Socket Lock	2
DE-W4P	4-Contact Socket Lock	2
DE-W6P	6-Contact Socket Lock	2
DE-W12P	12-Contact Socket Lock	1
DE-W2S	2-Contact Plug Lock	2
DE-W3S	3-Contact Plug Lock	2
DE-W4S	4-Contact Plug Lock	2
DE-W6S	6-Contact Plug Lock	2
DE-W12S	12-Contact Plug Lock	1
DE-0460-202-16141	16-20GA Solid Pin Contact	20
DE-0460-215-16141	14-16GA Solid Pin Contact	20
DE-0462-201-16141	16-20GA Solid Socket Contact	20
DE-0462-209-16141	14-16GA Solid Socket Contact	20
DE-0411-310-1605	Contact Removal Tool 16-18GA	1
DE-114017	Sealing Cavity Plug 12-16GA	25

FOR MORE INFORMATION ON DEUTSCH CONNECTORS SEE PAGE A14

INSULATED CONNECTOR ASSORTMENTS



PART# TK-21 - TERMINAL KIT

300 pieces of the 16 most popular terminals we sell. These are stored in a sturdy 21-compartment metal storage box. **BX-ML21**

PART# TK-21C - TERMINAL KIT

301 pieces. This is the same as the TK-21 and also includes our popular **CR-1 crimper** in the handy side compartment. These are stored in a sturdy 21-compartment metal storage box. **BX-ML21**

PART#	DESCRIPTION	QTY
A2B	22-18GA Vinyl Butt Connector	15
B2B	16-14GA Vinyl Butt Connector	15
C2B	12-10GA Vinyl Butt Connector	15
A2R-10	22-18GA Vinyl Ring Terminal #10	15
B2R-6	16-14GA Vinyl Ring Terminal #6	15
B2R-10	16-14GA Vinyl Ring Terminal #10	15
B2R-14	16-14GA Vinyl Ring Terminal 1/4"	15
B2R-38	16-14GA Vinyl Ring Terminal 3/8"	15
C2R-10	12-10GA Vinyl Ring Terminal #10	15
C2R-38	12-10GA Vinyl Ring Terminal 3/8"	15
B2S-6	16-14GA Vinyl Spade Terminal #6	15
B2S-10	16-14GA Vinyl Spade Terminal #10	15
B2FE-250	16-14GA Vinyl Insulated Female .250" Tab	15
B2M-250	16-14GA Vinyl Insulated Male .250" Tab	15
A6FE-250	22-18GA Nylon Fully Insulated Female .250" Tab	15
B6FE-250	16-14GA Nylon Fully Insulated Female .250" Tab	15
A6M-250	22-18GA Nylon Fully Insulated Male .250" Tab	15
B6M-250	16-14GA Nylon Fully Insulated Male .250" Tab	15
B6FEB	16-14GA Nylon Fully Insulated Receptacle .156"	15
B2BU	16-14GA Vinyl Insulated Bullet .156"	15

FOR MORE INFORMATION ON TERMINALS SEE PAGES A2 - A6.

Toll Free: 800-922-6527 • Fax: 248-634-2022 • www.statewire.com

SHRINK TUBE TERMINAL ASSORTMENTS

Terminals with Shrink Tubing may be used in a variety of ways for corrosion resistant crimp connections. For autos, farm equipment, field generating equipment, marine, mining, off-road construction vehicles, outdoor and roadway lighting, portable cord cable repair, recreational vehicles, refineries, submersible pumps, swimming pools, mass transit and recreational vehicles.

PART# TK-21ST - SHRINK TUBE KIT





100 pieces of the most popular shrink tube terminals we sell. There are **5 pieces** of each terminal. These are stored in a sturdy 21-compartment metal storage box. **BX-ML21**

PART# TK-21STX - SHRINK TUBE KIT

200 pieces. This contains the same shrink tube terminals as TK-21ST with **10 pieces** of each terminal. These are stored in a sturdy 21-compartment metal storage box. **BX-ML21**



FOR MORE INFORMATION ON SHRINK TUBE TERMINALS SEE PAGES A2 - A6

PART#	DESCRIPTION	TK-21ST	TK-21STX	
A1B-ST	22-18GA Butt Connector	5	10	
B1B-ST	16-14GA Butt Connector	5	10	
C1B-ST	12-10GA Butt Connector	5	10	
A1R-6ST	22-18GA Ring Terminal #6	5	10	
A1R-10ST	22-18GA Ring Terminal #10	5	10	
B1R-6ST	16-14GA Ring Terminal #6	5	10	
B1R-10ST	16-14GA Ring Terminal #10	5	10	
B1R-38ST	16-14GA Ring Terminal 3/8"	5	10	
C1R-6ST	12-10GA Ring Terminal #6	5	10	
C1R-10ST	12-10GA Ring Terminal #10	5	10	
C1R-38ST	12-10GA Ring Terminal 3/8"	5	10	
A1S-6ST	22-18GA Spade Terminal #6	5	10	
A1S-10ST	22-18GA Spade Terminal #10	5	10	
B1S-10ST	16-14GA Spade Terminal #10	5	10	
C1S-6ST	12-10GA Spade Terminal #6	5	10	
C1S-10ST	12-10GA Spade Terminal #10	5	10	
B6FE-250ST	16-14GA Female .250" Tab	5	10	
C6FE-250ST	12-10GA Female .250" Tab	5	10	
B6M-250ST	16-14GA Male .250" Tab	5	10	
C6M-250ST	12-10GA Male .250" Tab	5	10	



FOR MORE INFORMATION ON MULTI-WALL AND TINTED SHRINK TUBE SEE PAGE C8

MULTI-WALL SHRINK TUBE ASSORTMENTS

PART# ST-MWKIT45

45 pieces of shrink tube. Contains 30 pieces of Multi-Wall shrink tube and 15 pieces of translucent shrink tube. These are stored in a 6-compartment large plastic storage box. **BX-PL06.**

PART#	DESCRIPTION	I.D.	LENGTH	COLOR	QTY
ST-MW1820	Shrink tubing, semi-rigid, adhesive-lined	.205"	6"	Pink	5
ST-MW1416	Shrink tubing, semi-rigid, adhesive-lined	.240"	6"	Blue	5
ST-MW1012	Shrink tubing, semi-rigid, adhesive-lined	.305"	6"	Yellow	5
ST-MW12PKG	Shrink tubing, flexible, adhesive-lined	.500"	1-1/2"	Black	5
ST-MW12RPKG	Shrink tubing, flexible, adhesive-lined	.500"	1-1/2"	Red	5
ST-MW34PKG	Shrink tubing, flexible, adhesive-lined	.750"	1-1/2"	Black	5
ST-MW34RPKG	Shrink tubing, flexible, adhesive-lined	.750"	1-1/2"	Red	5
ST-MW1PKG	Shrink tubing, flexible, adhesive-lined	1.000"	1-1/2"	Black	5
ST-MW1RPKG	Shrink tubing, flexible, adhesive-lined	1.000"	1-1/2"	Red	5

PART# ST-MWKIT120

120 pieces of multi-wall shrink tube. Shrinks with a 3 to 1 ratio for weatherproof connections and has a meltable sealant to permanently protect electrical connections. These are stored in a 12-compartment metal storage box. **BX-ML12.**

PART#	DESCRIPTION	I.D.	LENGTH	COLOR	QTY
ST-MW316PKG	Shrink tubing, flexible, adhesive-lined	.180"	1-1/2"	Black	10
ST-MW316RPKG	Shrink tubing, flexible, adhesive-lined	.180"	1-1/2"	Red	10
ST-MW14PKG	Shrink tubing, flexible, adhesive-lined	.250"	1-1/2"	Black	10
ST-MW14RPKG	Shrink tubing, flexible, adhesive-lined	.250"	1-1/2"	Red	10
ST-MW38PKG	Shrink tubing, flexible, adhesive-lined	.370"	1-1/2"	Black	10
ST-MW38RPKG	Shrink tubing, flexible, adhesive-lined	.370"	1-1/2"	Red	10
ST-MW12PKG	Shrink tubing, flexible, adhesive-lined	.500"	1-1/2"	Black	10
ST-MW12RPKG	Shrink tubing, flexible, adhesive-lined	.500"	1-1/2"	Red	10
ST-MW34PKG	Shrink tubing, flexible, adhesive-lined	.750"	1-1/2"	Black	10
ST-MW34RPKG	Shrink tubing, flexible, adhesive-lined	.750"	1-1/2"	Red	10
ST-MW1PKG	Shrink tubing, flexible, adhesive-lined	1.000"	1-1/2"	Black	10
ST-MW1RPKG	Shrink tubing, flexible, adhesive-lined	1.000"	1-1/2"	Red	10

BLADE FUSE ASSORTMENTS

PART#	DESCRIPTION	COLOR	AMPS	QTY
ATM-3	Mini Blade	Violet	3	25
ATM-5	Mini Blade	Tan	5	25
ATM-10	Mini Blade	Red	10	25
ATM-15	Mini Blade	Blue	15	25
ATM-20	Mini Blade	Yellow	20	25
ATM-25	Mini Blade	Clear	25	25
ATM-30	Mini Blade	Green	30	25
ATC-1	Standard Blade	Black	1	25
ATC-3	Standard Blade	Violet	3	25
ATC-5	Standard Blade	Tan	5	25
ATC-7-1/2	Standard Blade	Brown	7-1/2	25
ATC-10	Standard Blade	Red	10	25
ATC-15	Standard Blade	Blue	15	25
ATC-20	Standard Blade	Yellow	20	25
ATC-25	Standard Blade	Clear	25	25
ATC-30	Standard Blade	Green	30	25
MAX-20	Maxi Blade	Yellow	20	1
MAX-30	Maxi Blade	Green	30	1
MAX-40	Maxi Blade	Orange	40	1
MAX-50	Maxi Blade	Red	50	1
MAX-60	Maxi Blade	Blue	60	1
ATM-TAP	Hot-line tap in for Blade Mini Fuses			50
ATC-TAP	Hot-line tap in for Blade Standard Fuses			50



FOR MORE INFORMATION ON BLADE FUSES SEE PAGE B8

PART# FA-KIT505

505 pieces of blade fuses and fuse taps. These are stored in a 24-compartment metal storage box. **BX-ML24**

ATM FUSES: ATM mini fuses are quickly growing in popularity for late-model OEM applications. ATM fuses use the same color coding as ATC style. ATM fuses feature an enclosed element - offering protection against shocks and sparks, plus corrosion resistance for longer service life.

ATC FUSES: ATC Blade fuses are widely used by automotive OEM's. Reflects industry universal color coding to indicate amperage. ATC fuses feature an enclosed element - offering protection against shocks and sparks, plus corrosion resistance for longer service life. Direct interchange for ATO applications.

MAXI FUSES: Maxi Fuses are used to protect circuits in the wiring harness usually found under the hood, in a fuse panel or supplementary panel near the battery. Primarily used in domestic cars, MAX fuses also have some applications in imported models.



COPPER BATTERY LUG KIT

PART# BTC-KIT135

135 pieces of copper battery lugs. These are stored in a 24-compartment metal storage box. **BX-ML24**



PART#	DESCRIPTION	GAUGE	STUD SIZE	QTY
BTC-614	Unplated Copper Lug	6	1/4"	10
BTC-656	Unplated Copper Lug	6	5/16"	10
BTC-414	Unplated Copper Lug	4	1/4"	10
BTC-456	Unplated Copper Lug	4	5/16"	10
BTC-438	Unplated Copper Lug	4	3/8"	10
BTC-238	Unplated Copper Lug	2	3/8"	10
BTC-138	Unplated Copper Lug	1	3/8"	10
BTC-1038	Unplated Copper Lug	1/0	3/8"	5
BTC-1012	Unplated Copper Lug	1/0	1/2"	5
BTC-2038	Unplated Copper Lug	2/0	3/8"	5
BTC-2012	Unplated Copper Lug	2/0	1/2"	5
BTC-3038	Unplated Copper Lug	3/0	3/8"	5
BTC-3012	Unplated Copper Lug	3/0	1/2"	5
BTC-P1&238	Heavy Duty Plated Lug	1&2	3/8"	5
BTC-P438	Heavy Duty Plated Lug	4	3/8"	5
JNC-3/8	Jam Nut		3/8"-16	25

FOR MORE INFORMATION ON COPPER BATTERY LUGS SEE PAGE A19

G6 BRASS FITTING ASSORTMENTS

SOLD INDIVIDUALLY

STANDARD COMPRESSION BRASS KIT (FOR COPPER AND PLASTIC TUBING)

PART# C-KIT290

290 pieces of standard compression brass fittings. The diagram on the inside cover of the kit allows easy identification. These are stored in a 24-compartment metal storage box. **BX-ML24**



PART #	TYPE	O.D. TUBE	PIPE THREAD	QTY	PICTURE
C-0060-3	Standard Sleeve	3/16"		50	
C-0060-4	Standard Sleeve	1/4"		50	
C-0060-5	Standard Sleeve	5/16"		50	
C-0060-6	Standard Sleeve	3/8"		20	
C-0061-3	Nut	3/16"		10	
C-0061-4	Nut	1/4"		10	
C-0061-5	Nut	5/16"		10	
C-0061-6	Nut	3/8"		10	
C-0062-3	Union	3/16"		5	
C-0062-4	Union	1/4"		5	
C-0062-5	Union	5/16"		5	
C-0062-6	Union	3/8"		5	
C-0068-32	Male Connector	3/16"	1/8"	5	
C-0068-42	Male Connector	1/4"	1/8"	5	
C-0068-52	Male Connector	5/16"	1/8"	5	
C-0068-54	Male Connector	5/16"	1/4"	5	
C-0068-64	Male Connector	3/8"	1/4"	5	
C-0068-66	Male Connector	3/8"	3/8"	5	
C-0069-32	Male Elbow	3/16"	1/8"	5	
C-0069-42	Male Elbow	1/4"	1/8"	5	
C-0069-52	Male Elbow	5/16"	1/8"	5	
C-0069-54	Male Elbow	5/16"	1/4"	5	
C-0069-64	Male Elbow	3/8"	1/4"	5	
C-0069-66	Male Elbow	3/8"	3/8"	5	

FOR MORE INFORMATION ON STANDARD COMPRESSION BRASS FITTINGS SEE PAGE K4

AIR BRAKE NYLON TUBE FITTINGS KIT

PART# C-KIT136

136 pieces of airbrake nylon tube fittings. The diagram on the inside cover of the kit allows easy identification. These are stored in a 24-compartment metal storage box. **BX-ML24**



PART #	TYPE	O.D. TUBE	PIPE THREAD	QTY	PICTURE
C-0460-4	Standard Sleeve	1/4"		10	
C-0460-6	Standard Sleeve	3/8"		10	
C-0460-8	Standard Sleeve	1/2"		10	
C-0460-10	Standard Sleeve	5/8"		5	
C-0461-4	Nut	1/4"		5	
C-0461-6	Nut	3/8"		5	
C-0461-8	Nut	1/2"		5	
C-0461-10	Nut	5/8"		5	
C-0462-4	Union	1/4"		5	
C-0462-6	Union	3/8"		5	
C-0462-8	Union	1/2"		2	
C-0462-10	Union	5/8"		2	
C-0463-4	Tube Support	1/4"		10	
C-0463-6	Tube Support	3/8"		10	
C-0463-8	Tube Support	1/2"		10	
C-0463-10	Tube Support	5/8"		10	
C-0468-44	Male Connector	1/4"	1/4"	5	
C-0468-66	Male Connector	3/8"	3/8"	5	
C-0468-86	Male Connector	1/2"	3/8"	5	
C-0469-44	Male Elbow	1/4"	1/4"	5	
C-0469-64	Male Elbow	3/8"	1/4"	5	
C-0469-86	Male Elbow	1/2"	3/8"	2	

FOR MORE INFORMATION ON AIRBRAKE NYLON TUBE FITTINGS SEE PAGE K2

PUSH TO CONNECT AIR BRAKE KIT

PART# C-KIT38

38 piece kit containing push to connect air brake fittings. These are stored in a 24-compartment metal storage box. **BX-ML24** DOT MARKED AND APPROVED.



PART #	TYPE	O.D. TUBE	PIPE THREAD	QTY	PICTURE
C-0962-4	Airbrake Union	1/4"		2	
C-0962-6	Airbrake Union	3/8"		2	
C-0962-8	Airbrake Union	1/2"		1	
C-0964-4	Airbrake Union Tee	1/4"		1	
C-0964-6	Airbrake Union Tee	3/8"		1	
C-0964-8	Airbrake Union Tee	1/2"		1	
C-0965-4	Airbrake Union Elbow	1/4"		1	
C-0965-6	Airbrake Union Elbow	3/8"		1	
C-0965-8	Airbrake Union Elbow	1/2"		1	
C-0968-42	Airbrake Male Connector	1/4"	1/8"	2	
C-0968-44	Airbrake Male Connector	1/4"	1/4"	2	
C-0968-46	Airbrake Male Connector	1/4"	3/8"	2	
C-0968-64	Airbrake Male Connector	3/8"	1/4"	2	
C-0968-66	Airbrake Male Connector	3/8"	3/8"	2	
C-0968-68	Airbrake Male Connector	3/8"	1/2"	2	
C-0968-86	Airbrake Male Connector	1/2"	3/8"	1	
C-0968-88	Airbrake Male Connector	1/2"	1/2"	1	
C-0969-42	Airbrake Male Elbow	1/4"	1/8"	2	
C-0969-44	Airbrake Male Elbow	1/4"	1/4"	2	
C-0969-46	Airbrake Male Elbow	1/4"	3/8"	2	
C-0969-64	Airbrake Male Elbow	3/8"	1/4"	2	
C-0969-66	Airbrake Male Elbow	3/8"	3/8"	2	
C-0969-86	Airbrake Male Elbow	1/2"	3/8"	1	
C-0969-88	Airbrake Male Elbow	1/2"	1/2"	1	

FOR MORE INFORMATION ON PUSH TO CONNECT AIRBRAKE FITTINGS SEE PAGE K2.

COLORED NYLON TIE-RAP ASSORTMENT

PART# NT-KIT600C

600 piece kit containing 6 colors of nylon tie-raps. Length 7-1/2", Width .190" and tensile strength 50 lbs. These are stored in a large 6-compartment plastic storage box. **BX-PL06**

FOR MORE INFORMATION ON COLORED NYLON TIE-RAPS SEE PAGE A16

PART#	COLOR	QTY
NT-B7	Black	100
NT-7BLU	Blue	100
NT-7GRN	Green	100
NT-7ORG	Orange	100
NT-7PNK	Pink	100
NT-7YEL	Yellow	100



BLACK NYLON TIE-RAP ASSORTMENT

PART# NT-KIT700BL

700 piece kit containing the most popular sizes of black ultraviolet resistant nylon tie-raps. These are stored in an adjustable metal storage box. **BX-ML-ADJ-H**



PART#	DESCRIPTION	LENGTH	T.S.*	WIDTH	QTY
NT-B4	Light Duty	3-3/4"	18 Lbs.	.085"	100
NT-B6	Standard Duty	6-1/32"	40 Lbs.	.135"	100
NT-B7	Standard Duty	7-7/16"	50 Lbs.	.190"	100
NT-BH7	Standard Duty W/ Mounting Hole	8"	50 Lbs.	.190"	100
NT-B11	Standard Duty	11-1/2"	50 Lbs.	.190"	100
NT-B14	Standard Duty	14-1/2"	50 Lbs.	.190"	100
NT-B14HD	Heavy Duty	14-3/4"	120 Lbs.	.310"	100

* TENSILE STRENGTH

FOR MORE INFORMATION ON NYLON TIE-RAPS SEE PAGE A17

G8 NUT AND BOLT ASSORTMENTS

SOLD INDIVIDUALLY

GRADE 5

PART# HB-40AST

2500 Piece assorted zinc plated nuts, bolts and washers 1/4-20 thru 1/2-13. Includes HB-40 bin and labels. All items are tested, certified and zinc plated.

PART# HB-80AST

3175 Piece assorted zinc plated nuts, bolts and washers 1/4-20 thru 1/2-13. Includes 2 HB-40 bins and labels. All items are tested, certified and zinc plated.



GRADE 8

PART# HB8-40AST

2500 Piece assorted zinc plated nuts, bolts and washers 1/4-20 thru 1/2-13. Includes HB-40 bin and labels. All items are tested, certified and zinc plated.

PART# HB8-80AST

3175 Piece assorted zinc plated nuts, bolts and washers 1/4-20 thru 1/2-13. Includes 2 HB-40 bins and labels. All items are tested, certified and zinc plated.

GRADE 5 PART#	SIZE	HB-40AST QTY	HB-80AST QTY
CAP SCREWS			
CSC-1434	1/4-20 X 3/4"		100
CSC-141	1/4-20 X 1"	100	100
CSC-14114	1/4-20 X 1-1/4"		100
CSC-14112	1/4-20 X 1-1/2"	100	100
CSC-142	1/4-20 X 2"	100	100
CSC-14212	1/4-20 X 2-1/2"	100	100
CSC-5161	5/16-18 X 1"	100	100
CSC-516112	5/16-18 X 1-1/2"	100	100
CSC-5162	5/16-18 X 2"	50	50
CSC-516212	5/16-18 X 2-1/2"		50
CSC-5163	5/16-18 X 3"		50
CSC-516312	5/16-18 X 3-1/2"		50
CSC-381	3/8-16 X 1"	50	50
CSC-38112	3/8-16 X 1-1/2"	50	50
CSC-382	3/8-16 X 2"	50	50
CSC-38212	3/8-16 X 2-1/2"		50
CSC-383	3/8-16 X 3"		50
CSC-38312	3/8-16 X 3-1/2"		50
CSC-7161	7/16-14 X 1"	50	50
CSC-716112	7/16-14 X 1-1/2"	50	50
CSC-7162	7/16-14 X 2"	25	25
CSC-716212	7/16-14 X 2-1/2"		25
CSC-7163	7/16-14 X 3"		25
CSC-716312	7/16-14 X 3-1/2"		25
CSC-121	1/2-13 X 1"	50	50
CSC-12112	1/2-13 X 1-1/2"	25	25
CSC-122	1/2-13 X 2"		25
CSC-12212	1/2-13 X 2-1/2"		25
CSC-123	1/2-13 X 3"		25
CSC-12312	1/2-13 X 3-1/2"		25
FLAT WASHERS			
FW-USS-1/4	1/4"	100	100
FW-USS-5/16	5/16"	100	100
FW-USS-3/8	3/8"	100	100
FW-USS-7/16	7/16"	100	100
FW-USS-1/2	1/2"	100	100
HEX NUTS			
HNC5-1/4	1/4-20"	100	100
HNC5-5/16	5/16-18"	100	100
HNC5-3/8	3/8-16"	100	100
HNC5-7/16	7/16-14"	100	100
HNC5-1/2	1/2-13"	100	100
LOCK WASHERS			
LW-1/4	1/4"	100	100
LW-5/16	5/16"	100	100
LW-3/8	3/8"	100	100
LW-7/16	7/16"	100	100
LW-1/2	1/2"	100	100
HB-40 BIN	33-3/4" X 8-1/2" X 22-1/4"	1	2

GRADE 8 PART#	SIZE	HB8-40AST QTY	HB8-80AST QTY
CAP SCREWS			
CSC8-1434	1/4-20 X 3/4"		100
CSC8-141	1/4-20 X 1"	100	100
CSC8-14114	1/4-20 X 1-1/4"		100
CSC8-14112	1/4-20 X 1-1/2"	100	100
CSC8-142	1/4-20 X 2"	100	100
CSC8-14212	1/4-20 X 2-1/2"	100	100
CSC8-5161	5/16-18 X 1"	100	100
CSC8-516112	5/16-18 X 1-1/2"	100	100
CSC8-5162	5/16-18 X 2"	50	50
CSC8-516212	5/16-18 X 2-1/2"		50
CSC8-5163	5/16-18 X 3"		50
CSC8-516312	5/16-18 X 3-1/2"		50
CSC8-381	3/8-16 X 1"	50	50
CSC8-38112	3/8-16 X 1-1/2"	50	50
CSC8-382	3/8-16 X 2"	50	50
CSC8-38212	3/8-16 X 2-1/2"		50
CSC8-383	3/8-16 X 3"		50
CSC8-38312	3/8-16 X 3-1/2"		50
CSC8-7161	7/16-14 X 1"	50	50
CSC8-716112	7/16-14 X 1-1/2"	50	50
CSC8-7162	7/16-14 X 2"	25	25
CSC8-716212	7/16-14 X 2-1/2"		25
CSC8-7163	7/16-14 X 3"		25
CSC8-716312	7/16-14 X 3-1/2"		25
CSC8-121	1/2-13 X 1"	50	50
CSC8-12112	1/2-13 X 1-1/2"	25	25
CSC8-122	1/2-13 X 2"		25
CSC8-12212	1/2-13 X 2-1/2"		25
CSC8-123	1/2-13 X 3"		25
CSC8-12312	1/2-13 X 3-1/2"		25
FLAT WASHERS			
FW8-USS-1/4	1/4"	100	100
FW8-USS-5/16	5/16"	100	100
FW8-USS-3/8	3/8"	100	100
FW8-USS-7/16	7/16"	100	100
FW8-USS-1/2	1/2"	100	100
HEX NUTS			
HNC8-1/4	1/4-20"	100	100
HNC8-5/16	5/16-18"	100	100
HNC8-3/8	3/8-16"	100	100
HNC8-7/16	7/16-14"	100	100
HNC8-1/2	1/2-13"	100	100
LOCK WASHERS			
LW8-1/4	1/4"	100	100
LW8-5/16	5/16"	100	100
LW8-3/8	3/8"	100	100
LW8-7/16	7/16"	100	100
LW8-1/2	1/2"	100	100
HB-40 BIN	33-3/4" X 8-1/2" X 22-1/4"	1	2

SOLD
INDIVIDUALLY

NUT AND BOLT ASSORTMENTS

G9

GRADE 8.8

PART# HB-40METRIC

1580 Piece assorted steel plated metric nuts, bolts and washers. Includes HB-40 bin and labels. All Items are tested, certified and zinc plated.



GRADE 10.9

PART# HB10-80METRIC

2640 Piece assorted steel plated metric nuts, bolts and washers. Includes 2 HB-40 bins and labels. All Items are tested, certified and zinc plated.

HB-40METRIC PART#	SIZE	GRADE 8.8 PITCH	QTY
CAP SCREWS			
CSM-6X20	6MM X 20MM	1.0	50
CSM-6X25	6MM X 25MM	1.0	50
CSM-6X35	6MM X 35MM	1.0	50
CSM-6X45	6MM X 45MM	1.0	25
CSM-8X20	8MM X 20MM	1.25	50
CSM-8X25	8MM X 25MM	1.25	25
CSM-8X35	8MM X 35MM	1.25	25
CSM-8X45	8MM X 45MM	1.25	25
CSM-10X25	10MM X 25MM	1.5	25
CSM-10X35	10MM X 35MM	1.5	25
CSM-10X45	10MM X 45MM	1.5	15
CSM-10X55	10MM X 55MM	1.5	15
CSM-12X25	12MM X 25MM	1.75	15
CSM-12X35	12MM X 35MM	1.75	15
CSM-12X45	12MM X 45MM	1.75	10
CSM-12X55	12MM X 55MM	1.75	10
HEX NUTS			
HNM-6	6MM	1.0	100
HNM-8	8MM	1.25	100
HNM-10	10MM	1.5	100
HNM-12	12MM	1.75	50
FLAT WASHERS			
		I.D.	
FWM-6	6MM	6.4	100
FWM-8	8MM	8.4	100
FWM-10	10MM	10.5	100
FWM-12	12MM	13.0	100
LOCK WASHERS			
		I.D.	
LWM-6	6MM	6.1	100
LWM-8	8MM	8.1	100
LWM-10	10MM	10.2	100
LWM-12	12MM	12.2	100
HB-40 BIN	33-3/4" X 8-1/2" X 22-1/4"		1

HB10-80METRIC PART#	SIZE	GRADE 10.9 PITCH	QTY
CAP SCREWS			
CSM10-6X20	6MM X 20MM	1.0	100
CSM10-6X25	6MM X 25MM	1.0	100
CSM10-6X35	6MM X 35MM	1.0	100
CSM10-6X45	6MM X 45MM	1.0	100
CSM10-8X20	8MM X 20MM	1.25	50
CSM10-8X25	8MM X 25MM	1.25	50
CSM10-8X35	8MM X 35MM	1.25	100
CSM10-8X45	8MM X 45MM	1.25	100
CSM10-10X25	10MM X 25MM	1.5	100
CSM10-10X35	10MM X 35MM	1.5	100
CSM10-10X45	10MM X 45MM	1.5	100
CSM10-10X55	10MM X 55MM	1.5	100
CSM10-12X25	12MM X 25MM	1.75	25
CSM10-12X35	12MM X 35MM	1.75	25
CSM10-12X45	12MM X 45MM	1.75	50
CSM10-12X50	12MM X 50MM	1.75	50
CSM10-14X40	14MM X 40MM	2.0	20
CSM10-14X60	14MM X 60MM	2.0	20
HEX NUTS			
HNM10-6	6MM	1.0	100
HNM10-8	8MM	1.25	100
HNM10-10	10MM	1.5	100
HNM10-12	12MM	1.75	25
HNM10-14	14MM	2.0	25
FLAT WASHERS			
		I.D.	
FWM10-6	6MM	6.4	100
FWM10-8	8MM	8.4	100
FWM10-10	10MM	10.5	100
FWM10-12	12MM	13.0	100
FWM10-14	14MM	15.0	100
LOCK WASHERS			
		I.D.	
LWM10-6	6MM	6.1	100
LWM10-8	8MM	8.1	100
LWM10-10	10MM	10.2	100
LWM10-12	12MM	12.2	100
LWM10-14	14MM	14.2	100
HB-40 BIN	33-3/4" X 8-1/2" X 22-1/4"		2

NUT and BOLT BINS

PART#	COMPARTMENTS	WIDTH	DEPTH	HEIGHT
HB-40	40	33-3/4"	8-1/2"	22-1/4"

All welded, prime cold rolled steel. Fully hemmed 1-1/8" bin fronts to hold labels and retain parts. Roll-formed sides for increased strength and stability. Mounting holes are located both the top and bottom. Durable gray powder-coat finish.



Toll Free: 800-922-6527 • Fax: 248-634-2022 • www.statewire.com

PAN HEAD PHILLIPS DRIVE

PART# SMSPX-KIT

1050 piece kit containing stainless steel pan head phillips drive sheet metal screws. These are housed in a sturdy 24-compartment metal storage box. **BX-ML24**

PART#	SIZE	QTY
SMSPX612	6 X 1/2"	50
SMSPX634	6 X 3/4"	50
SMSPX61	6 X 1"	50
SMSPX6114	6 X 1-1/4"	50
SMSPX6112	6 X 1-1/2"	50
SMSPX812	8 X 1/2"	50
SMSPX834	8 X 3/4"	50
SMSPX81	8 X 1"	50
SMSPX8114	8 X 1-1/4"	50
SMSPX8112	8 X 1-1/2"	50
SMSPX82	8 X 2"	50
SMSPX1012	10 X 1/2"	50
SMSPX1034	10 X 3/4"	50
SMSPX101	10 X 1"	50
SMSPX10114	10 X 1-1/4"	50
SMSPX10112	10 X 1-1/2"	50
SMSPX102	10 X 2"	50
SMSPX1434	14 X 3/4"	50
SMSPX141	14 X 1"	50
SMSPX14114	14 X 1-1/4"	25
SMSPX14112	14 X 1-1/2"	25
SMSPX142	14 X 2"	25
SMSPX14212	14 X 2-1/2"	25

18-8 STAINLESS STEEL SHEET METAL SCREW ASSORTMENT



FOR MORE INFORMATION ON STAINLESS STEEL SHEET METAL SCREWS SEE PAGE D15

OVAL HEAD PHILLIPS DRIVE

PART# SMSOXS-KIT

1050 piece kit containing stainless steel oval head phillips drive sheet metal screws. These are housed in a sturdy 24-compartment metal storage box. **BX-ML24**

PART#	SIZE	QTY
SMSOXS612	6 X 1/2"	50
SMSOXS634	6 X 3/4"	50
SMSOXS61	6 X 1"	50
SMSOXS6114	6 X 1-1/4"	50
SMSOXS6112	6 X 1-1/2"	50
SMSOXS812	8 X 1/2"	50
SMSOXS834	8 X 3/4"	50
SMSOXS81	8 X 1"	50
SMSOXS8114	8 X 1-1/4"	50
SMSOXS8112	8 X 1-1/2"	50
SMSOXS82	8 X 2"	50
SMSOXS1012	10 X 1/2"	50
SMSOXS1034	10 X 3/4"	50
SMSOXS101	10 X 1"	50
SMSOXS10114	10 X 1-1/4"	50
SMSOXS10112	10 X 1-1/2"	50
SMSOXS102	10 X 2"	50
SMSOXS1434	14 X 3/4"	50
SMSOXS141	14 X 1"	50
SMSOXS14114	14 X 1-1/4"	25
SMSOXS14112	14 X 1-1/2"	25
SMSOXS142	14 X 2"	25
SMSOXS14212	14 X 2-1/2"	25

PAN HEAD QUAD/SQUARE DRIVE SHEET METAL SCREW KIT

PART# SMSSQ-KIT2400

2400 piece kit containing pan head quad/square drive sheet metal screws. The perfect kit for RV's. These are housed in a sturdy 24-compartment metal storage box. **BX-ML24**

PART#	SIZE	QTY
SMSPQ-612	6 X 1/2"	100
SMSPQ-634	6 X 3/4"	100
SMSPS-61*	6 X 1"	100
SMSPQ-6112	6 X 1-1/2"	100
SMSPQ-812	8 X 1/2"	100
SMSPQ-834	8 X 3/4"	100
SMSPQ-81	8 X 1"	100
SMSPQ-8112	8 X 1-1/2"	100
SMSPS-1012*	10 X 1/2"	100
SMSPQ-1034	10 X 3/4"	100
SMSPQ-101	10 X 1"	100
SMSPS-10112*	10 X 1-1/2"	100
SMSPQW-812	8 X 1/2"	100
SMSPQW-834	8 X 3/4"	100
SMSPQW-81	8 X 1"	100
SMSPQW-8112	8 X 1-1/2"	100
SMSPQW-82	8 X 2"	100
STATUARY BRONZE SCREWS		
SMSPQWBRZ-834	8 X 3/4"	100
SMSPQWBRZ-81	8 X 1"	100
SMSPQWBRZ-8112	8 X 1-1/2"	100
SMSPQWBRZ-82	8 X 2"	100
POLAR WHITE SCREWS		
SMSPQWHT-834	8 X 3/4"	100
SMSPQWHT-81	8 X 1"	100
SMSPQWHT-8112	8 X 1-1/2"	100

* Square Drive



FOR MORE INFORMATION ON SHEET METAL SCREWS SEE PAGE D12

PAN HEAD PHILLIPS DRIVE SHEET METAL SCREW KIT



PART# SMSPX-KIT-L

825 piece kit containing pan head phillips drive sheet metal screws. For the expanding service area, order this assortment. These are housed in a sturdy 24-compartment metal storage box. **BX-ML24**

PART#	SIZE	QTY
SMSPX-812	8 X 1/2"	100
SMSPX-834	8 X 3/4"	100
SMSPX-81	8 X 1"	100
SMSPX-8112	8 X 1-1/2"	50
SMSPX-1012	10 X 1/2"	50
SMSPX-1034	10 X 3/4"	50
SMSPX-101	10 X 1"	50
SMSPX-10112	10 X 1-1/2"	50
SMSPX-1212	12 X 1/2"	50
SMSPX-1234	12 X 3/4"	50
SMSPX-121	12 X 1"	25
SMSPX-12112	12 X 1-1/2"	25
SMSPX-1434	14 X 3/4"	50
SMSPX-141	14 X 1"	50
SMSPX-14112	14 X 1-1/2"	25
SMSPX-142	14 X 2"	25

SOLD INDIVIDUALLY

SCREW ASSORTMENTS

G11

HEX HEAD WASHER & PAN HEAD PHILLIPS TEK SCREW ASSORTMENT



PART# TS-KIT825L

825 piece kit containing hex head washer and pan head phillips tek screws. These are housed in a sturdy 24-compartment metal storage box. Includes hex and phillips bits.

BX-ML24

FOR MORE INFORMATION ON TEK SCREWS SEE PAGE D13

PART#	SIZE	HEAD SIZE	QTY
TS-812	8 X 1/2"	1/4"	50
TS-834	8 X 3/4"	1/4"	50
TS-81	8 X 1"	1/4"	50
TS-8112	8 X 1-1/2"	1/4"	50
TS-1012	10 X 1/2"	5/16"	50
TS-1034	10 X 3/4"	5/16"	50
TS-101	10 X 1"	5/16"	50
TS-10112	10 X 1-1/2"	5/16"	25
TS-1234	12 X 3/4"	5/16"	25
TS-121	12 X 1"	5/16"	25
TS-12112	12 X 1-1/2"	5/16"	25
TS-1434	14 X 3/4"	3/8"	25
TS-141	14 X 1"	3/8"	25
TS-14112	14 X 1-1/2"	3/8"	25
TS-PX812	8 X 1/2"	#2	50
TS-PX834	8 X 3/4"	#2	50
TS-PX81	8 X 1"	#2	50
TS-PX1012	10 X 1/2"	#2	50
TS-PX1034	10 X 3/4"	#2	50
TS-PX101	10 X 1"	#2	50

410 STAINLESS STEEL TEK SCREW KIT



PART# TS-SSKIT600

600 piece kit containing stainless steel hex washer, flat phillips and pan phillips head tek screws. Includes Hex and Phillips bits. These are housed in a sturdy 16-compartment plastic storage box. **BX-PL16**

FOR MORE INFORMATION ON TEK SCREWS SEE PAGE D13

PART#	SIZE	HEAD SIZE	QTY
TS-S812	8 X 1/2"	1/4"	50
TS-S834	8 X 3/4"	1/4"	50
TS-S81	8 X 1"	1/4"	50
TS-SPX812	8 X 1/2"	#2	50
TS-SPX834	8 X 3/4"	#2	50
TS-SPX81	8 X 1"	#2	50
TS-SPX8112	8 X 1-1/2"	#2	25
TS-SPX1034	10 X 3/4"	#2	25
TS-SPX101	10 X 1"	#2	25
TS-SFX61	6 X 1"	#2	50
TS-SFX834	8 X 3/4"	#2	50
TS-SFX81	8 X 1"	#2	50
TS-SFX8112	8 X 1-1/2"	#2	25
TS-SFX1034	10 X 3/4"	#2	25
TS-SFX101	10 X 1"	#2	25

PAN HEAD PHILLIPS MACHINE SCREW KIT



PART# MSPX-KIT1600

1600 piece kit containing pan head phillips drive machine screws. These are housed in a sturdy 24-compartment metal storage box. **BX-ML24**

FOR MORE INFORMATION ON MACHINE SCREWS SEE PAGE D11

PART#	SIZE	THREAD	QTY
MSCPX-612	6 X 1/2"	6-32	50
MSCPX-634	6 X 3/4"	6-32	50
MSCPX-61	6 X 1"	6-32	50
MSCPX-6112	6 X 1-1/2"	6-32	50
MSCPX-812	8 X 1/2"	8-32	50
MSCPX-834	8 X 3/4"	8-32	50
MSCPX-81	8 X 1"	8-32	50
MSCPX-8112	8 X 1-1/2"	8-32	50
MSCPX-1012	10 X 1/2"	10-24	50
MSCPX-1034	10 X 3/4"	10-24	50
MSCPX-101	10 X 1"	10-24	50
MSCPX-10112	10 X 1-1/2"	10-24	50
MSFPX-1012	10 X 1/2"	10-32	50
MSFPX-1034	10 X 3/4"	10-32	50
MSFPX-101	10 X 1"	10-32	50
MSFPX-10112	10 X 1-1/2"	10-32	50
MHN-632	#6	6-32	100
MHN-832	#8	8-32	100
MHN-1024	#10	10-24	100
MHN-1032	#10	10-32	100
FW-SAE-6	#6		100
FW-SAE-8	#8		100
FW-SAE-10	#10		100
FW-USS-10	#10		100

PLATED COTTER PIN KIT

PART# CP-KIT950L

950 piece kit containing plated cotter pins. These are housed in a sturdy 24-compartment metal storage box. **BX-ML24**



PART #	DIA	LENGTH	QTY
CP-116X1	1/16"	1"	100
CP-116X112	1/16"	1-1/2"	100
CP-332X1	3/32"	1"	100
CP-332X112	3/32"	1-1/2"	100
CP-332X2	3/32"	2"	100
CP-332X212	3/32"	2-1/2"	100
CP-18X1	1/8"	1"	50
CP-18X112	1/8"	1-1/2"	50
CP-18X2	1/8"	2"	50
CP-18X212	1/8"	2-1/2"	50
CP-532X112	5/32"	1-1/2"	25
CP-532X2	5/32"	2"	25
CP-532X212	5/32"	2-1/2"	25
CP-316X112	3/16"	1-1/2"	25
CP-316X2	3/16"	2"	25
CP-316X212	3/16"	2-1/2"	25

FOR MORE INFORMATION ON COTTER PINS SEE PAGE D10

INSULATED METAL CLAMPS KIT

PART# RIC-KIT230L

230 piece kit containing insulated metal clamps. These are housed in a sturdy 12-compartment metal storage box. **BX-ML12**



FOR MORE INFORMATION ON INSULATED METAL CLAMPS SEE PAGE C9

WIRE CADDY ASSORTMENT

PART# BXR-M920KIT

920 piece kit containing seven 100ft rolls of primary wire, butt connectors, ring terminals, quick disconnect terminals, a crimping tool and a wire caddy to hold all parts. These are stored in a portable metal storage box with 4 rods to hold wire spools.



PART#	DESCRIPTION	GAUGE	SIZE	COLOR	QTY
CR-1	Crimper				1EA
PW16-YEL	Primary Wire	16		Yellow	100 FT
PW16-GRN	Primary Wire	16		Green	100 FT
PW16-BRN	Primary Wire	16		Brown	100 FT
PW14-BLK	Primary Wire	14		Black	100 FT
PW14-RED	Primary Wire	14		Red	100 FT
PW12-WHT	Primary Wire	12		White	100 FT
PW12-BLU	Primary Wire	12		Blue	100 FT
A2B	Butt Connector	22-18		Red	25 EA
B2B	Butt Connector	16-14		Blue	25 EA
C2B	Butt Connector	12-10		Yellow	25 EA
B2R-10	Ring Terminal	16-14	#10 Stud	Blue	25 EA
B2R-56	Ring Terminal	16-14	5/16 Stud	Blue	25 EA
C2R-10	Ring Terminal	12-10	#10 Stud	Yellow	25 EA
C2R-38	Ring Terminal	12-10	3/8 Stud	Yellow	25 EA
B6FE-250	Quick Disconnect Terminals	16-14	1/4" Tab	Blue	25 EA
B6M-250	Quick Disconnect Terminals	16-14	1/4" Tab	Blue	25 EA

FOR MORE INFORMATION ON PRIMARY WIRE SEE PAGE C2 & TERMINALS PAGES A2, A4 and A6

HITCH PIN CLIP KIT

PART# HPC-KIT105

105 piece kit containing hitch pin clips. These are housed in a small 12-compartment plastic storage box. **BX-PS12**



FOR MORE INFORMATION ON HITCH PIN CLIPS SEE PAGES D8-9

PART#	DRILL HOLE SIZE	SHAFT DIAMETER MIN	SHAFT DIAMETER MAX	OVERALL LENGTH	QTY
HPC-31	1/32"	1/8"	5/32"	.600"	10
HPC-21	1/16"	1/8"	3/16"	19/32"	10
HPC-24	1/16"	1/4"	3/8"	1-9/16"	10
HPC-18	5/64"	3/8"	1/2"	1-9/16"	10
HPC-13	3/32"	1/4"	3/8"	1-3/16"	10
HPC-03	7/64"	1/4"	1/2"	1-5/8"	10
HPC-28	7/64"	3/8"	1/2"	2"	10
HPC-14	7/64"	3/8"	3/4"	2-1/2"	10
HPC-11	9/64"	7/16"	3/4"	2-9/16"	10
HPC-09	5/32"	3/4"	1-1/8"	3-5/16"	5
HPC-10	5/32"	5/8"	1"	2-15/16"	5
HPC-04*	3/16"	1/2 x 3/4"	5/8 x 1"	3"	5

* for rectangular shaft

PART#	I.D.	WIDTH	BOLT HOLE SIZE	QTY
RIC-S1/4	1/4"	1/2"	9/32"	25
RIC-S3/8	3/8"	1/2"	9/32"	25
RIC-S1/2	1/2"	1/2"	9/32"	25
RIC-S3/4	3/4"	1/2"	9/32"	15
RIC-S1	1"	1/2"	9/32"	15
RIC-S1-1/2SLV*	1-1/2"	1/2"	9/32"	10
RIC-L1/4	1/4"	3/4"	13/32"	25
RIC-L3/8	3/8"	3/4"	13/32"	25
RIC-L1/2	1/2"	3/4"	13/32"	25
RIC-L3/4	3/4"	3/4"	13/32"	15
RIC-L1	1"	3/4"	13/32"	15
RIC-L1-1/2	1-1/2"	3/4"	13/32"	10

* Sleeved clamp

SOLD
INDIVIDUALLY

ASSORTMENTS

G13

PLASTIC GROMMET ASSORTMENT

PART# PG-KIT150

150 piece kit containing various sizes of plastic grommets. These are housed in a 6-compartment plastic storage box. **BX-PL06**



PART #	INSIDE DIAMETER	MOUNTING HOLE	OVERALL HEIGHT	QTY
PG-1/8	1/8"	1/4"	5/16"	25
PG-1/4	1/4"	3/8"	13/32"	25
PG-3/8	3/8"	1/2"	13/32"	25
PG-1/2	1/2"	5/8"	13/32"	25
PG-5/8	5/8"	3/4"	13/32"	25
PG-3/4	3/4"	1"	29/64"	25

FOR MORE INFORMATION ON PLASTIC GROMMETS SEE PAGE D18

RUBBER GROMMET ASSORTMENT

PART# RG-KIT130

130 piece kit containing various sizes of rubber grommets. These are housed in a sturdy 24-compartment metal storage box. **BX-ML24**

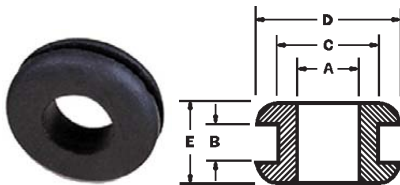

PART #	(A) BORE DIA.	(B) GROOVE THICKNESS	(C) GROOVE DIA.	(D) OUTSIDE DIA.	(E) OVERALL THICKNESS	QTY
RG18332	1/8"	3/32"	3/8"	1/2"	5/16"	10
RG532116	5/32"	1/16"	1/4"	3/8"	3/16"	10
RG532332	5/32"	3/32"	1/4"	7/16"	3/8"	10
RG316116	3/16"	1/16"	5/16"	1/2"	1/4"	10
RG31614	3/16"	1/4"	5/16"	7/16"	3/8"	10
RG14116	1/4"	1/16"	7/16"	5/8"	3/16"	10
RG516116	5/16"	1/16"	7/16"	9/16"	3/16"	10
RG51618	5/16"	1/8"	9/16"	13/16"	3/8"	5
RG51614	5/16"	1/4"	9/16"	13/16"	1/2"	5
RG38116	3/8"	1/16"	1/2"	11/16"	9/32"	5
RG381161	3/8"	1/16"	1"	1-1/4"	1/4"	5
RG3814	3/8"	1/4"	5/8"	7/8"	1/2"	5
RG12332	1/2"	3/32"	3/4"	31/32"	9/32"	5
RG1218	1/2"	1/8"	3/4"	1"	1/2"	5
RG1214	1/2"	1/4"	13/16"	1-1/16"	1/2"	5
RG5818	5/8"	1/8"	7/8"	1-1/8"	3/8"	5
RG58116	5/8"	1/16"	7/8"	1-1/8"	5/16"	5
RG34116	3/4"	1/16"	15/16"	1-1/8"	1/4"	5
RG3414	3/4"	1/4"	1-1/4"	1-5/8"	7/16"	5

FOR MORE INFORMATION ON RUBBER GROMMETS SEE PAGE D18

SOLDER SLUG ASSORTMENT

PART# BTCR-SLUG-KIT60

Pre-measured pieces of flux-core solder, sized to provide correct amount of solder for each size of cable connector. Assortment contains 10 each of the following gauges: 4, 2, 1, 1/0, 2/0 and 3/0 and is assembled in a sturdy 6-compartment plastic box. **BX-PS06**



PART#	GAUGE	COLOR	QTY
BTCR-SLUG4	4	Grey	10
BTCR-SLUG2	2	Green	10
BTCR-SLUG1	1	Pink	10
BTCR-SLUG1/0	1/0	Black	10
BTCR-SLUG2/0	2/0	Orange	10
BTCR-SLUG3/0	3/0	Purple	10

FOR MORE INFORMATION ON SOLDER SLUGS SEE PAGE A9

Toll Free: 800-922-6527 • Fax: 248-634-2022 • www.statewire.com

ROLL PIN ASSORTMENT



PART# RP-KIT600

600 piece kit containing various sizes of plated roll pins. These are housed in a sturdy 24-compartment metal storage box. **BX-ML24**

PART#	DIA.	LENGTH	WALL THICKNESS	QTY
RP-116X12	1/16"	1/2"	.012"	25
RP-116X1	1/16"	1"	.012"	25
RP-332X12	3/32"	1/2"	.022"	25
RP-332X1	3/32"	1"	.022"	25
RP-332X112	3/32"	1-1/2"	.022"	25
RP-18X12	1/8"	1/2"	.028"	25
RP-18X34	1/8"	3/4"	.028"	25
RP-18X1	1/8"	1"	.028"	25
RP-18X112	1/8"	1-1/2"	.028"	25
RP-18X2	1/8"	2"	.028"	25
RP-532X12	5/32"	1/2"	.032"	25
RP-532X34	5/32"	3/4"	.032"	25
RP-532X1	5/32"	1"	.032"	25
RP-532X112	5/32"	1-1/2"	.032"	25
RP-532X2	5/32"	2"	.032"	25
RP-316X34	3/16"	3/4"	.040"	25
RP-316X1	3/16"	1"	.040"	25
RP-316X112	3/16"	1-1/2"	.040"	25
RP-316X2	3/16"	2"	.040"	25
RP-14X34	1/4"	3/4"	.050"	25
RP-14X1	1/4"	1"	.050"	25
RP-14X112	1/4"	1-1/2"	.050"	25
RP-14X2	1/4"	2"	.050"	25
RP-14X212	1/4"	2-1/2"	.050"	25

FOR MORE INFORMATION ON PLATED ROLL PINS
SEE PAGE D10

HOSE CLAMP ASSORTMENT

PART# HC-AST

90 Pieces. 10 Pieces of each size. Popular stock merchandiser is ideally suited for tight places, yet gets plenty of attention. Effectively organizes and displays your clamp stock. Made to stand alone or mount on wall. Includes rack. **HC-RACK.**



PART#	MINIMUM	MAXIMUM
MINI CLAMP SIZES (5/16 Band)		
HC-M4	7/32"	5/8"
HC-M6	7/16"	25/32"
REGULAR CLAMP SIZES (1/2 Band)		
HC-10	9/16"	1-1/16"
HC-12	11/16"	1-1/4"
HC-20	13/16"	1-3/4"
HC-24	1-1/16"	2"
HC-28	1-5/16"	2-1/4"
HC-32	1-9/16"	2-1/2"
HC-36	1-13/16"	2-3/4"

FOR MORE INFORMATION ON HOSE CLAMPS
SEE PAGE C9

MAGNETIC CHUCK DRIVE KIT

PART# PMC-KIT30

30 piece kit containing various sizes of insert and power bits. These are housed in a plastic storage box. **BX-PSADJ-H**

This assortment is great for shop use or for your retail counter. It contains the most popular sizes - based on what you, the customer, have told us. All items shown in the kit come in bulk packaging. Empty boxes are also available for customizing your own assortments.

PART#	DRIVE	DESCRIPTION	OAL	QTY
TMC-20	Torx	For Screw #8	1"	2
TMC-25	Torx	For Screw #10	1"	2
TMC-30	Torx	For Screw #14	1"	2
TMC-40	Torx	For Screw 5/16	1"	2
PMC-2	Phillips	For #5, 6, 8, 10 Screws	1"	4
PMC-2L	Phillips	For #5, 6, 8, 10 Screws	1-15/16"	2
PMC-2XL	Phillips	For #5, 6, 8, 10 Screws	2-3/4"	2
PMC-3	Phillips	For #12, 14 Screws	1"	2
SMC-2	Square	For #8, 10 Screws	1"	2
SMC-2L	Square	For #8, 10 Screws	1-15/16"	2
SMC-2XL	Square	For #8, 10 Screws	2-3/4"	2
SMC-3	Square	For #12, 14 Screws	1"	2
HMC14	Hex	For 1/4" Hex Head Screws	2"	1
HMC516	Hex	For 5/16" Hex Head Screws	1-3/4"	1
HMC38	Hex	For 3/8" Hex Head Screws	1-7/8"	1
HMC716	Hex	For 7/16" Hex Head Screws	1-7/8"	1

FOR MORE INFORMATION ON INSERT AND POWER BITS SEE PAGE H13



SOLD INDIVIDUALLY

ASSORTMENTS

G15

GREASE FITTING ASSORTMENT

PART# GF-KIT110

110 piece kit housed in a small 12-compartment plastic storage box. **BX-PS12.**

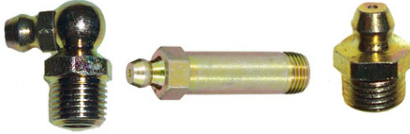

PART #	SIZE	DESCRIPTION	OAL	QTY
C-0641	1/4-28"	Male Thread - Short	17/32"	10
C-0680	1/4-28"	Male Thread - Long	15/16"	10
C-0638	1/4-28"	Male Thread - 90° Angle	47/64"	10
C-0637	1/4-28"	Male Thread - 45° Angle	7/8"	10
C-0610	1/8	Male Pipe Thread - Short	11/16"	10
C-0667	1/8	Male Pipe Thread - Long	1-1/4"	10
C-0613	1/8	Male Pipe Thread - 90° Angle	13/16"	10
C-0688	1/8	Male Pipe Thread - 45° Angle	1"	10
C-3641	6mm X 1.0 Pitch	Straight	14 mm	10
C-3610	8mm X 1.0 Pitch	Straight	15 mm	10
C-3710	10mm X 1.0 Pitch	Straight	15 mm	10

FOR MORE INFORMATION ON GREASE FITTINGS SEE PAGE D18

VACUUM HOSE CONNECTOR KIT

PART# VHC-KIT90

90 piece kit housed in a small 18-compartment plastic storage box. **BX-PS18.**



PART #	DESCRIPTION	SIZE	QTY
AVC-12929	Nylon Connector	1/8"	5
AVC-12937	Nylon Connector	3/16"	5
AVC-12931	Nylon Connector	1/4"	5
AVC-12946	Nylon Connector	5/16"	5
AVC-12930	Nylon Connector	1/8 x 3/16"	5
AVC-12935	Nylon Connector	3/16 x 1/4"	5
AVC-12923	Nylon Tee	1/8"	5
AVC-12918	Nylon Tee	3/16"	5
AVC-17629	Nylon Tee	1/4"	5
AVC-12947	Nylon Elbow	1/8 x 3/16"	5
AVC-12932	Nylon Elbow	3/16"	5
AVC-12933	Nylon Elbow	1/4"	5
AVC-12209	Rubber Cap	1/8"	10
AVC-04440	Rubber Cap	3/16"	10
AVC-04439	Rubber Cap	1/4"	10

ALL ALUMINUM BLIND RIVET KIT

PART# BR-KIT626

626 piece kit including hand rivet gun. These are housed in a sturdy 21-compartment metal storage box. **BX-ML21**



*Large flange dome head

PART #	RIVET DIAMETER	PANEL WIDTH	GRIP RANGE	QUANTITY
BR4-2AAD	1/8"	1/8"	.065-.125"	50
BR4-4AAD	1/8"	1/4"	.125-.250"	50
BR4-4AADL*	1/8"	1/4"	.125-.250"	50
BR4-8AAD	1/8"	1/2"	.375-.500"	25
BR6-2AAD	3/16"	1/8"	.065-.125"	25
BR6-4AAD	3/16"	1/4"	.125-.250"	25
BR6-4AADL*	3/16"	1/4"	.125-.250"	25
BR6-6AAD	3/16"	3/8"	.250-.375"	25
BR6-6AADL*	3/16"	3/8"	.250-.375"	25
BR6-8AAD	3/16"	1/2"	.375-.500"	25
BR6-8AADL*	3/16"	1/2"	.375-.500"	25
BR6-10AAD	3/16"	5/8"	.500-.625"	25
BR6-10AADL*	3/16"	5/8"	.500-.625"	25
BR6-12AAD	3/16"	3/4"	.625-.750"	25
BLIND RIVET BACK-UP WASHERS				
BRBUW-4A	For Rivet Diameter 1/8"			100
BRBUW-6A	For Rivet Diameter 3/16"			100
TOOL				
BR-HP2	Hand Rivet Gun 3/32" - 3/16"			1

FOR MORE INFORMATION ON BLIND RIVETS SEE PAGE D16-17

STORAGE SYSTEMS

WIRE RACK

PART# PW-R

Store your spooled wire on our heavy duty rack for easier handling. Utilizes 4 sturdy steel rods and provides storage for reels as large as 10" in diameter. Shipped knocked down and easily assembled. Dimensions: **37-1/8" H x 26-1/8" W x 6" D.** Made of prime cold rolled steel interlocking construction. Comes in a gray baked enamel. Spooled wire sold separately.



WIRE & TERMINAL CADDY

PART# BXR-M920

Heavy duty cold-rolled steel construction. Durable baked enamel finish. Used for storage of terminals and crimp tool in top and wire in lower area. Comes with 4 rods for storing spools of wire. Exterior Dimensions: **16-3/4" H x 11" W x 7-1/2" D.** Sold Individually



Toll Free: 800-922-6527 • Fax: 248-634-2022 • www.statewire.com

METAL STORAGE SYSTEMS

Our black metal storage units are of quality construction. Only prime cold-rolled steel is used and finishes are rust and acid resistant baked enamel. High impact plastic inserts allow for a variety of configurations.

LARGE BOX SYSTEMS

18" W x 3" H x 12" D

BOX#	COMPARTMENTS
BX-ML12	12
BX-ML21	21
BX-ML24	24
BX-ML32	32
BX-MLADJ-H	Adjust-Horz.
BX-MLADJ-V	Adjust-Vert.
RACK#	BOXES HELD
BXR-ML4	4

INSERT#	COMPARTMENTS
BXI-MLADJ-H	Adjust-Horz.
BXI-MLADJ-V	Adjust-Vert.
BXI-ML12	12
BXI-ML21	21
BXI-ML24	24
BXI-ML32	32



BOXES AND RACK SOLD SEPARATELY

18-DRAWER CABINET



PART#	DESCRIPTION	QTY
DR-18	18 Drawer Cabinet	1
DR-18DIVIDER	High Impact Dividers	12

Quality construction of prime, cold-rolled steel with acid resistant gray baked enamel finish. DR-18 includes the dividers. 33-3/4" W x 11-5/8" D x 10-7/8" H.

NUT and BOLT BINS



PART#	COMPARTMENTS	WIDTH	DEPTH	HEIGHT
HB-40	40	33-3/4"	8-1/2"	22-1/4"

All welded, prime cold rolled steel. Fully hemmed 1-1/8" bin fronts to hold labels and retain parts. Roll-formed sides for increased strength and stability. Mounting holes are located at both the top and bottom.

PLASTIC STORAGE SYSTEMS

These high-strength, oil resistant polypropylene boxes are ideal for organizing, storing and protecting a wide variety of small parts and tools. Different configurations to choose from allow a wide selection of compartment sizes and shapes to fit just about every need and budget.

LARGE BOX SYSTEMS

13-1/8" W x 2-5/16" H x 9" D

BOX#	COMPARTMENTS
BX-PL06	6
BX-PL12	12
BX-PL16	16
BX-PL24	24
RACK#	BOXES HELD
BXR-PS5	5



BOXES AND RACKS SOLD SEPARATELY

SMALL BOX SYSTEMS

11" W x 1-3/4" H x 6-3/4" D

BOX#	COMPARTMENTS
BX-PS06	6
BX-PS12	12
BX-PS13	13
BX-PS18	18
RACK#	BOXES HELD
BXR-PS5	5

QUICK INDEX SECTION H

H1

Tools and Accessories

- H2** Crimpers and Wire Strippers
- H3** Circuit Testers, MBX Tools, Utility Knives and Blades, Masks and Gloves
- H4-5** Mini Flap Discs, Surface Conditioning Discs, Bristle Discs, Roloc Discs and Disc Holders, Fiber Discs, Scotch-Brite Pads, Fabricut Rolls, Cloth Utility Rolls, Knotted and Crimped Wire End Brushes
- H6-7** Flap Discs, Depressed Center Wheels, Flap Wheels, Wire Wheels, Scratch Brushes, Cut-Off Wheels, Grinding Wheels, Chop Saw and Portable Saw Blades

- H8-9** Hole Saw Blades and Kits, Arbors, Pilot Drills, Hacksaw Frame and Blades, Vari Bits
- H10-11** Jobber Length, Sheet Metal, Mechanics Length, Reduced Shank Drill Bits and Drill Bit Size Table
- H12** Insert and Power Bits
- H13** Alkaline Batteries, Rough Service Bulbs and Butane Torches
- H14** Booster Cable Handles, Battery Charging Clips, Protective Boots, Ignition Wire and Ends, Drop Lights and Accessories

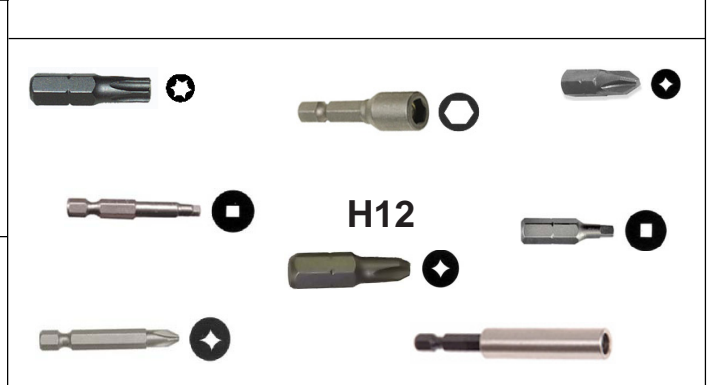
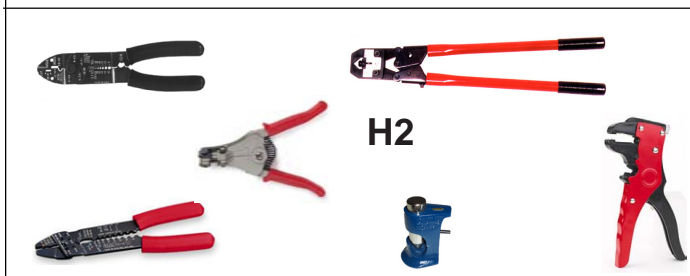



PART# CR-1
Precision Stamped Metal
 8-22 gauge wire range. Cuts wire on the end. Crimps insulated, bare and 7MM ignition terminals. Cuts bolts and strips wire.



PART# CR-4
Heavy-Duty
 10-22 gauge wire range. Rugged and lightweight. Cushioned grips. Forged steel. Crimps both insulated and uninsulated terminals and splices.



PART# CR-6
Heavy Duty Precision Stamped Metal
 Made of high strength, heat treated carbon steel. Handles a variety of terminal and conductor styles, including uninsulated flags, closed-end connectors, crimp sleeves and standard insulated and non-insulated terminals. 6-26 gauge wire range.

PART# AVC-16004
Weatherpack Crimper

Used to crimp open barrel connectors. Wire range of 14-24 gauge.



25 inches

PART# CR-HD
Hand Crimper.

For 8-4/0 gauge battery terminals and lugs.

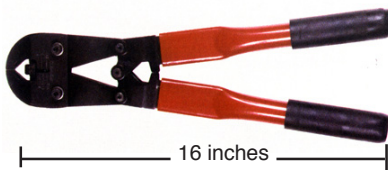

16 inches

PART# CR-HD-S
Hand Crimper.

For 8-1/0 gauge battery terminals and lugs.



PART# CR-BTC

Use with vise or hammer.
 Crimps cable range 6-4/0 gauge.

PART# CR-12-9002

Ratcheting Weather Pack Crimper

Heavy duty steel construction. Compound leverage for ease of operation. Wide selection of interchangeable dies. Dies are marked with application. Crimp pressure adjustment. Ergonomic handle design for comfortable extended use. Ratcheting design insures positive exacting crimps. Used for 12-22 gauge non-insulated terminals.



PART# RG6-129021

Ratcheting Coaxial Crimp Tool

Heavy duty steel construction. Compounded leverage for ease of operation. Crimp pressure adjustment. Ratcheting design insures positive exacting crimps. Wide selection of interchangeable dies. Dies are marked with application.



PART# CR-TR50

Ratchet Crimper

Designed for shrink tube connectors and will crimp 8, 10-12, 14-16 and 18-22 gauge insulated terminals. Ensures uniform crimp termination regardless of user. Release switch if terminal or wire is inserted improperly. High quality tool. Alignment guide to ensure dies won't slip during crimping.



PART# WC-CUTTER

Welding cable cutter.

High-leverage cutter shears up to 2/0 gauge copper cable with ease. **(Not for cutting steel.)** Compact size makes it easy to use. Convenient to carry.



PART# WS-1

Heavy Duty Wire Stripper.

Stripping tool with precision blades. Self-adjusting wire stripper for 8-26 gauge wire. Makes a clean strip without damaging the wire strands. Cushion grip for comfort. 8" long.

PART# WS-2

Wire Stripper

All automatic wire strippers should be this easy to use! Insert a wire, squeeze the handles and you're finished. Multiple conductors may be stripped at one time for consistency, and a convenient wire cutter is featured below the stripping jaws. Works with 10-20 gauge stranded or solid wire. Tension may be adjusted via a top mounted knurled thumb screw. Strip length up to 7/8" (23 mm). Compact 6-3/4" OAL design. Packaged in a retail clamshell for display.





PART# CT
6-12 Volt Tester and Probe
 Quickly checks all 6 and 12 volt systems. With power on, locates shorts, grounds and open circuits. 36" wire lead with fully-insulated alligator clip. Uses W-47 or W-1847 bulb. **Sold Individually.**

PART# CT-10
12-24 Volt Tester
 Fasten ground clamp, push forward on sleeve collar. Hook wire. Pull back on collar with thumb. Probe will pierce insulation. If circuit is live, handle will light. Hole in tip also allows use as probe tester. Just pull back on collar. Operates with one hand. Pierces toughest insulation. Long nose reaches where fingers can't. Hangs on wire, freeing both hands. Break resistant plastic. Heavy-duty ground clamp. 44" of 16 gauge wire. Completely insulated. **J-121-22 bulb for 24V and J-121-18 bulb for 12V.** For use on autos, trucks, recreational vehicles, boats, snowmobiles and motorcycles. **Sold Individually.**



PART# MBX-MP3500
MBX Air Blaster
 Pneumatic power tool, heavy duty, 3500 rpm with adapter system for 23mm brush belts / 31mm rubber eraser (**rubber eraser and belts are sold separately**). For automotive, aviation and other industries. **Sold Individually.**



PART# MBX-RE0023
31MM Rubber Eraser for decal removal
 Toothed wheel construction. Removes vinyl decals, stickers, DOT tape and glue from metal surfaces, fiberglass, plate glass, wood, aluminum and OEM paint finish. **Sold Individually.**

PART# MBX-ME3200
MBX Electric Blaster
 Electric power tool, 3200 rpm with adapter system for 23mm brush belts / 31mm rubber eraser (**rubber eraser and belts are sold separately**). For sign and graphic and for onsite usage. **Sold Individually.**

UTILITY KNIFE AND BLADES



PART# BLD-KNIFE
 Fully retractable utility knife. Metal body utility knife with overlap nose for safety. Blade storage in handle. Accepts most utility blades. 10 locked blade positions. Includes 1 blade. **Sold Individually.**



PART# BLD-SINGLE
 Regular duty single edge razor blade in slide open box. .009" High carbon surgical steel. Each blade protected in shelling paper. Non-rust aluminum back. Fits most standard razor blade tools. Ideal for scraping paint and glass, cutting and trimming wallpaper, etc. **Standard Package 100.**



Part# BLD-UTILITY
 Heavy Duty .025" 2-notch utility blades. Made of precision ground high carbon knife steel for rugged use. Can be used in most standard utility knives. For cutting drywall, fiberglass, wood, plastic and cardboard. **Standard Package 100.**



High speed steel edge with titanium coating keeps blades cutting after others have quit. Patented bi-metal construction allows blades to bend and flex without breaking. Four notch system allows blade to extend further. Great for cutting drywall, insulation, flooring, roofing and more. Fits most standard utility knives.

PART#	STD PKG
LE-GOLD5C	5 / Card
LE-GOLD50D	50 / Dispenser



PART# AL-CSP113
 Comfort Mask has a self-supporting cup design that provides both economy and comfort. It offers relief only from irritating effects of common nuisance levels of dust such as alfalfa, pollen, animal dander and other nuisance level particles. Nuisance level refers to concentrations below the OSHA Permissible Exposure Limit (PEL). Do no use if the concentration levels are above PEL. **Standard Package 50 Masks / Box.**

Industrial Nitrile Powder-Free Gloves
 Protect against chemicals and abrasives. Fully textured latex and powder free. Nitrile is a synthetic material manufactured to be non allergenic, more puncture resistant and abrasion resistant.



PART#	SIZE	STD PKG
AVC-20690	Large	100 / Pack
AVC-20691	Extra Large	100 / Pack

MINI FLAP DISCS - TYPE R

PART#	DIAMETER	GRIT	STD PKG
AL-FDZ67411	2"	36	10
AL-FDZ67412	2"	40	10
AL-FDZ67413	2"	60	10
AL-FDZ67414	2"	80	10
AL-FDZ67431	3"	36	10
AL-FDZ67432	3"	40	10
AL-FDZ67433	3"	60	10
AL-FDZ67434	3"	80	10
AL-FDZ67435	3"	120	10



Quick change. Premium Zirconia. Available in 2" and 3" diameters with grit sizes 36, 40, 60, 80 and 120. Flap disc technology with the convenience and versatility of quick change discs. Combines grinding and finishing in one step. "Mini" size allows access to tight areas. Flap disc design extends life while providing a constantly "fresh" cutting surface and cooler operation. High quality zirconium is effective on materials from mild steel to exotic titanium alloys, composites and plastics. Excellent for polishing and finishing, grinding, chamfering, deburring and much more. Interchangeable with 3M Roloc™ series.

3M™ ROLOC™ BRISTLE DISCS

Super tough plastic bristle brush, embedded with abrasive. Wears as it cleans, continually exposing fresh abrasive. Interchangeable with 3M Roloc™. The ideal tool to replace scrapers, wire wheels and chemical gasket strippers. Eliminates the danger of loose wires flying back at operator. Safer for parts and the environment than hazardous chemical strippers. Maximum operating speeds allow for use on both die grinders and pistol grip grinders. **Use green on steel parts and yellow on aluminum parts for quick safe removal.** Bristles rise over surface cleaning contaminants without gouging surface. Use with 3M™ Roloc™ Disc Pad Assemblies **3M-05539 (2")** and **3M-05540 (3")**. **Standard Package 1 Box**

PART#	COLOR	SIZE	GRADE	DISCS PER BOX
3M-07524	Green	2"	50	10
3M-07525	Yellow	2"	80	10
3M-07526	Green	3"	50	10



TYPE R DISC HOLDERS

Disc Holders 1/4" shank. Interchangeable with 3M Roloc™. Semi-rigid rubber bends with disc on contoured surfaces. **Sold Individually**

PART#	DIA.
AL-QDH12	2"
AL-QDH13	3"
3M-05539	2"
3M-05540	3"



GREEN CORP® ROLOC™ DISCS



Black button. Generally used for hard to reach areas in paint, rust, and weld removal. Handy quick change tool for disc grinding which fits any standard 1/4 inch drill or air tool. **Standard Package 1 Box**

PART#	GRADE	DIA.	DISCS PER BOX
3M-01398	24	2"	25
3M-01397	36	2"	25
3M-01396	50	2"	25
3M-01408	24	3"	25
3M-01407	36	3"	25
3M-01406	50	3"	25

GREEN CORP® FIBER DISCS



Green Corp® fiber discs are used for grinding door skins, mig welds or any kind of metal or fiberglass grinding. Other applications include paint, rust, and weld removal and metal work. Standard class abrasive. 20 discs per box. **Standard Package 1 Box**

PART#	GRIT	SIZE
3M-01915	24	5 X 7/8
3M-01914	36	5 X 7/8

ABRASIVES

H5

3M™ SCOTCH-BRITE™ PADS



PART# 3M-07445

6" x 9" Scotch-Brite™ **white** light duty cleansing pad. Use on panel prior to clear coat blending. Does not rust like steel wool. This pad may be used with 3M™ Scuff-It™ paint prep gel for improved performance.
Standard Package 20 / Box



PART# 3M-07447

6" x 9" Scotch-Brite™ **maroon** general purpose hand pad. Use for scuffing before applying paint and primer surfacer. Does not rust like steel wool.
Standard Package 20 / Box



PART# 3M-07448

6" x 9" Scotch-Brite™ **gray** ultra fine hand pad. Use for final sanding of primer surfacer. Does not rust like steel wool. This pad may be used with 3M™ Scuff-It™ paint prep gel for improved performance.
Standard Package 20 / Box

3M™ FABRICUT ROLL



PART# 3M-05072

3M Fabricut roll. 1-1/2" x 25yds. Grit 120. Made from a flexible, synthetic open mesh screen-type backing. Coated on both sides with tough aluminum oxide mineral. Ideal for cleaning rusted or corroded surfaces. Can be used with or around water, oil, or axle grease without loading.
Standard Package 1 Roll

3M™ THREE-M-ITE™ ELEK-TRO-CUT™ CLOTH UTILITY ROLLS

Used for smoothing rough spots, deburring and cleaning metal surfaces.



PART#	GRIT	WIDTH	LENGTH	STD PKG
3M-05001	400	1"	50 Yards	1 Roll
3M-05002	320	1"	50 Yards	1 Roll
3M-05004	240	1"	50 Yards	1 Roll
3M-05005	220	1"	50 Yards	1 Roll
3M-05006	180	1"	50 Yards	1 Roll
3M-05007	150	1"	50 Yards	1 Roll
3M-05008	120	1"	50 Yards	1 Roll
3M-05009	100	1"	50 Yards	1 Roll
3M-05010	80	1"	50 Yards	1 Roll
3M-05028	120	1-1/2"	50 Yards	1 Roll
3M-05030	80	1-1/2"	50 Yards	1 Roll
3M-05049	100	2"	50 Yards	1 Roll



KNOTTED WIRE END BRUSH

PART# AL-WB67175

Knotted wire end brushes are great for hard to reach places. Applications include cleaning cylinder heads, pistons and valve ports, removal of rust, scale, paint tool polishing, weld cleaning, etc. 20000 Max RPM. Trim Length: 1". Wire Size: 0.020". Dia: 1" Shank Size: 1/4". **Sold Individually**



CRIMP WIRE END BRUSH

PART# AL-WB67121

1" Brush Diameter. Coarse grade. Small diameter end brushes are designed for use in restricted or hard to reach areas. They are excellent for carbon cleaning, finishing for appearance or finish preparation prior to painting or plating. 4500 RPM. **Sold Individually.**

FLAP DISCS

Type 27 - Flat and Type 29 - Beveled. Individual flaps are designed to wear away evenly and present a constantly fresh working surface. They provide a cooler and more efficient grinding effect than conventional disks. No back-up pads required. Best used for grinding and polishing of metals, blending of welds and other metal finishing. Resin bond. Fast cool cutting. Fiberglass back. Zirconia. **Standard Package 5**



TYPE 27 FLAT PART#	DISC DIA. x ARBOR HOLE SIZE	GRIT	RPM	ABRASIVE TYPE
AL-FDZ67470	4" X 5/8"	36	13700	Zirconia
AL-FDZ67472	4" X 5/8"	60	13700	Zirconia
AL-FDZ67473	4" X 5/8"	80	13700	Zirconia
AL-FDZ67475	4-1/2" X 7/8"	40	13500	Zirconia
AL-FDZ67497N*	4-1/2" X 5/8"-11	60	13500	Zirconia High Density

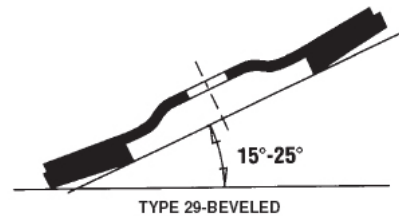
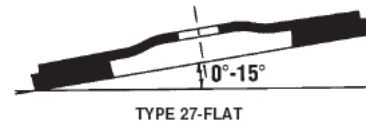

TYPE 29 BEVELED PART#	DISC DIA. x ARBOR HOLE SIZE	GRIT	RPM	ABRASIVE TYPE
AL-FDZ77475	4-1/2" X 7/8"	36	13500	Zirconia
AL-FDZ77476	4-1/2" X 7/8"	60	13500	Zirconia
AL-FDZ77477N*	4-1/2" X 5/8"-11	80	13500	Zirconia

* Part#'s with "N" represents discs with 5/8 -11 threaded arbor nut.

DEPRESSED CENTER WHEEL



PART# AL-DPC64042
Wheel Dia: 4-1/2". Thickness: .045".
Hole Dia: 7/8". Max RPM: 13300.
Fast, cool, burr free cutting for use on ferrous metals. Resin bonded. Fully Reinforced. Premium quality.
Standard Package 50

FLAP WHEELS



Aluminum oxide resin bond cloth. For polishing, deburring, edge blending, cleaning and smoothing on concave, convex, I.D. tubes, grooves, cavities and contoured parts. Delivers a consistent finish with a uniform rate of cut. Works on metals, plastics, rubbers and woods. 1/4" Shank Mounted Wheels. 25,000 RPM

PART#	GRIT	DIA.	FACE	STD PKG
AL-FW61751B	80	1"	1"	10 Wheels / Box
AL-FW61752B	80	1-1/2"	1"	10 Wheels / Box

CRIMPED WIDE FACE WIRE WHEEL



Crimped wide face wire wheel with multi-adapter arbor hole. General purpose brush for bench or pedestal grinders. Heavy duty, used for surface processing of metal, rubber, wood, plastic, glass, etc. **Sold Individually**

PART#	DIA.	WIRE SIZE	TRIM LENGTH	FACE WIDTH	MAX RPM
AL-WB67151	6"	0.012"	1-1/8"	3/4"	6500
AL-WB67153	8"	0.012"	1-5/8"	1-1/16"	4500

SCRATCH BRUSHES



PART# AL-WB67195
Long hardwood handle scratch brush with slightly curved handle designed for heavy duty cleaning. Stainless steel bristles. Trim length: 1-1/8". Wire rows: 3 x 19. Dimensions: 15/16" X 6" X 13-3/4".
Standard Package 5



PART# AL-WB67193
Toothbrush-style scratch brush makes a great welder's tool that can be used for a wide variety of cleaning applications. Stainless steel bristles. Trim length: 7/16". Wire rows: 3 x 7. Dimensions: 7/16" x 7-1/2".
Standard Package 10



CARDED WIRE WHEEL

PART# AL-WB67105C
Carded Wire Wheel. 1/4" Shank. 3" Diameter. Course grade. 4500 RPM.

ABRASIVES

H7

CUT-OFF WHEEL MANDREL



PART# CWM-3/8
1/4" Shank fits 3/8" Hole. For use on castings, steel fabrications, stainless steel ferrous and non ferrous metals, concrete, asphalt and brick. **Sold Individually.**



CUT-OFF WHEEL MANDREL SET



PART# AL-M61552
Cut Off Wheel Mandrel Set. Arbor 1/4" Shank. Fits 1/4" and 3/8" Hole. **Sold Individually.**

CUT-OFF WHEELS



For body shop, muffler shop, automotive and general dry cutting applications.



BENCH GRINDER WHEEL



PART# AL-GW73141
8" Diameter and 1" thick. High grade aluminium oxide. May be used with oil or water. Runs cool for long grinding life; maintains shape. **Sold Individually.**

PART#	O.D.	THICKNESS	MANDREL		STD PKG
			HOLE	RPM	
CW-3X1/16X3/8	3	1/16"	3/8"	25000	6 / Bag
CW-3X1/32X3/8	3	1/32"	3/8"	25000	6 / Bag
CW-3X3/32X3/8	3	3/32"	3/8"	25000	6 / Bag
CW-4X1/32X3/8	4	1/32"	3/8"	19000	6 / Bag
CW-4X3/32X3/8	4	3/32"	3/8"	19000	6 / Bag
AL-COW61510GP	4	1/16"	3/8"	19000	6 / Bag

GRINDING WHEELS (DEPRESSED CENTER) ALUMINIUM OXIDE



PART#	O.D.	THICKNESS	HOLE (ARBOR)	RPM
GW-4X1/4X5/8	4"	1/4"	5/8"	15300
GW-4-1/2X1/4X7/8	4-1/2"	1/4"	7/8"	13300
GW-4.5X1/4X5/8-11	4-1/2"	1/4"	5/8-11"	13200
GW-7X1/4X5/8-11	7"	1/4"	5/8-11"	8500
GW-9X1/4X5/8-11	9"	1/4"	5/8-11"	6600

Resinoid fully reinforced. Aluminium oxide for metal. Fast cutting. Excellent life.

SUPER THIN TYPE-1 ANGLE GRINDER WHEELS

For high speed burr free cutting.



PART#	O.D.	THICKNESS	HOLE (ARBOR)	RPM	APPLICATION
AL-COW61515	4-1/2"	.045"	7/8"	17000	Metal
AL-COW61515A	4-1/2"	.045"	7/8"	17000	Aluminum
AL-COW61517	6"	.045"	7/8"	14200	Metal

CHOP AND PORTABLE HIGH SPEED SAW BLADES

Chop saw blades used for portable machines. Ideal for cutting metal pipes, studs, steel structures, and bar stock. **Portable high speed saw blades** good for use on castings, steel fabrications, stainless steel ferrous and non ferrous metals, concrete, asphalt and brick.



CHOP SAW BLADE PART#	THICKNESS x OUTER DIA.	ARBOR HOLE	APPLICATION	STD PKG
AL-COW61541G	7/64" x 14"	1"	Externally Reinforced	10 per box
AL-COW61541GS	3/32" x 14"	1"	Internally Reinforced	10 per box

PORTABLE SAW BLADE PART#	THICKNESS x OUTER DIA.	ARBOR HOLE	APPLICATION	STD PKG
CW-PSB-12X1/8X1	1/8" x 12"	1"	Aluminum Oxide for Metal application	5 per box

Toll Free: 800-922-6527 • Fax: 248-634-2022 • www.statewire.com

H8

BLADES AND ACCESSORIES



HOLE SAW BLADES AND ACCESSORIES

Shatterproof, bi-metal construction. Vari-Tooth form gives less vibration, smoother cuts. Cuts through stainless steel and other metals, pipe, nail-embedded wood, hardwood floors, plywood and plastics. Stays sharp up to 3 times longer and resists heat build-up. A new heat treating process creates sharper tooth tips for faster, freer cutting.

ORDER BLADES / ARBORS / ACCESSORIES SEPARATELY

ARBORS

PART#	FITS HOLE SAWS	SHANK TYPE	CHUCK SIZE
LE-L01	L09-L19	Hex	1/2"
LE-L02	L20-L96	Hex	1/2"
LE-L04	L09-L96	Round	1/4"
LE-L05	L09-L19	Hex	3/8"
LE-L06	L20-L96	Hex	3/8"



PILOT DRILLS 1/4"



Part No. LE-PD56
Fits Arbors LE-L05, LE-L06



Part No. LE-4321
Fits Arbors LE-L01, LE-L02, LE-L04

HOLE SAW BLADES



PART#	DIAMETER	USE ARBOR #
LE-L10	5/8"	LE-L01, -L04, -L05
LE-L12	3/4"	LE-L01, -L04, -L05
LE-L16	1"	LE-L01, -L04, -L05
LE-L18	1-1/8"	LE-L01, -L04, -L05
LE-L20	1-1/4"	LE-L02, -L06
LE-L22	1-3/8"	LE-L02, -L06
LE-L24	1-1/2"	LE-L02, -L06
LE-L28	1-3/4"	LE-L02, -L06
LE-L32	2"	LE-L02, -L06
LE-L33	2-1/16"	LE-L02, -L06
LE-L36	2-1/4"	LE-L02, -L06
LE-L38	2-3/8"	LE-L02, -L06
LE-L40	2-1/2"	LE-L02, -L06
LE-L44	2-3/4"	LE-L02, -L06
LE-L48	3"	LE-L02, -L06
LE-L52	3-1/4"	LE-L02, -L06
LE-L56	3-1/2"	LE-L02, -L06
LE-L60	3-3/4"	LE-L02, -L06
LE-L64	4"	LE-L02, -L06
LE-L72	4-1/2"	LE-L02, -L06

ADDITIONAL SIZES AVAILABLE

HOLE SAW KITS



PART# LE-L1200 DELUXE KIT

Twelve popular sizes. One each of hole saws 5/8", 3/4", 7/8", 1", 1-1/8", 1-1/4", 1-3/8", 1-1/2", 1-3/4", 2", 2-1/2" and 3". One each of arbors LE-L01 and LE-L02. Three spare pilot drills. Plastic case. **Sold Individually.**



PART# LE-P600 PLUMBER KIT

Six sizes most commonly used for pipe tap and entrance. One each of hole saws 3/4", 7/8", 1-1/8", 1-1/2", 1-3/4" and 2-1/4". One each of arbors LE-L02 and LE-L04. One spare pilot drill. One arbor adapter. Plastic case. **Sold Individually.**

HACKSAW FRAME AND BLADES



PROFESSIONAL
GRADE

PART# HSF-1

Sturdy tubular hacksaw frame. Removable pin permits horizontal cuts. Blade storage compartment in the saw frame. **Sold Individually.**

EXTRA FLEXIBLE.
12 INCHES LONG
BI-METAL HSS TYPE.



PART#	TEETH PER INCH	STD PKG
HSB3-18	18	10
HSB3-24	24	10
HSB3-32	32	10

State Wire and Terminal, Inc.

BLADES AND VARI BITS

H9



RECIPROCATING BLADES (BI-METAL)

Standard Package: 5

PART#	SIZE (INCHES) (L x W x T)	TEETH PER INCH	RECOMMENDED USE
LE-R656	6 x 3/4 x .050	6	Fast cutting nail in wood.
LE-R606	6 x 3/4 x .035	6	Wood including nail embedded wood, all composition material
LE-R610	6 x 3/4 x .035	10	Wood including nail embedded wood, compositions, plastic, cast aluminum & non-ferrous metals.
LE-R614	6 x 3/4 x .035	14	Heavy gauge metal, rubber & fiber.
LE-R618	6 x 3/4 x .035	18	Heavy gauge metal, conduit & tubing
LE-R624	6 x 3/4 x .035	24	Metal & galvanized pipe 18 gauge & under
LE-R636B	6 x 3/4 x .035	6	Plaster, plaster board
LE-R810	8 x 3/4 x .050	10	Wood including nail embedded wood, compositions, plastic, cast aluminum, light non-ferrous metals
LE-R110	12 x 3/4 x .050	10/14	Wood including nail embedded wood, plastic & cast aluminum

AIRSAW AND JIGSAW BLADES (BI-METAL)

Standard Package: 5

PART#	SIZE (INCHES) (L x W x T)	TEETH PER INCH	RECOMMENDED USE
LE-J480	4-1/2 x 3/8 x .050	10	Smoother finish of wood, compositions, plastic
LE-T418	4 x 1/2 x .025	18	For pneumatic machine cutting applications
LE-T424	4 x 1/2 x .025	24	in automotive repairs
LE-T432	4 x 1/2 x .025	32	and sheet metal



VARI-BITS



LE-VB1 LE-VB2 LE-VB3 LE-VB4

Vari-Bit drill bits eliminate the need for specific sized bits for 1/8" to 1-1/8" diameter hole sizes. High speed steel double flute design cuts burr free holes faster (cuts twice as fast and lasts twice as long as any competitive bit). Three-sided shank won't slip in chuck. True drill point starts fast, requires no center punching. Drills steel, brass, copper, aluminum, wood and various plastics. **Sold Individually**



LE-VB6 LE-VB7 LE-VB8 LE-VB11

PART#	# OF HOLE SIZES	SIZE RANGE	ELECTRIC DRILL SIZE
LE-VB1	13	1/8"-1/2"	1/4"
LE-VB2	8	9/16"-1"	3/8"
LE-VB3	9	1/4"-3/4"	3/8"
LE-VB4	6	3/16"-1/2"	1/4"

PART#	# OF HOLE SIZES	SIZE RANGE	ELECTRIC DRILL SIZE
LE-VB6	2	3/8" & 1/2"	1/4"
LE-VB7	1	7/8"	3/8"
LE-VB8	12	3/16"-7/8"	3/8"
LE-VB11	2	7/8" & 1-1/8"	3/8"

Toll Free: 800-922-6527 • Fax: 248-634-2022 • www.statewire.com

H10

DRILL BITS

JOBBER LENGTHS - High Speed Steel



TYPE DB - Surface treated 118° Point - Preferred for **FERROUS** metals.



TYPE DBDF - Black and Gold finish 135° Split Point - For steels, **stainless steel** and other tough metals.



TYPE DBJDC - Cobalt Gold finish 135° Split Point - Preferred for **HARD WORKING** metals.

TYPE DB	TYPE DBDF	TYPE DBJDC	SIZE	FLUTE LENGTH	OVERALL LENGTH
DB-1/16	DBDF-1/16		1/16"	7/8"	1-7/8"
DB-5/64	DBDF-5/64		5/64"	1"	2"
DB-3/32	DBDF-3/32		3/32"	1-1/4"	2-1/4"
DB-7/64	DBDF-7/64		7/64"	1-1/2"	2-5/8"
DB-1/8	DBDF-1/8	DBJDC-1/8	1/8"	1-5/8"	2-3/4"
DB-9/64	DBDF-9/64		9/64"	1-3/4"	2-7/8"
DB-5/32	DBDF-5/32		5/32"	2"	3-1/8"
	DBDF-11/64		11/64"	2-1/8"	3-1/4"
DB-3/16	DBDF-3/16	DBJDC-3/16	3/16"	2-5/16"	3-1/2"
	DBDF-13/64		13/64"	2-7/16"	3-5/8"
DB-7/32	DBDF-7/32		7/32"	2-1/2"	3-3/4"
DB-15/64	DBDF-15/64		15/64"	2-5/8"	3-7/8"
DB-1/4	DBDF-1/4	DBJDC-1/4	1/4"	2-3/4"	4"
DB-17/64	DBDF-17/64		17/64"	2-7/8"	4-1/8"
	DBDF-19/64		19/64"	3-1/6"	4-3/8"
DB-5/16	DBDF-5/16	DBJDC-5/16	5/16"	3-3/16"	4-1/2"
	DBDF-21/64		21/64"	3-5/16"	4-5/8"
DB-11/32	DBDF-11/32		11/32"	3-7/16"	4-3/4"
DB-23/64	DBDF-23/64		23/64"	3-1/2"	4-7/8"
DB-3/8	DBDF-3/8	DBJDC-3/8	3/8"	3-5/8"	5"
	DBDF-25/64		25/64"	3-3/4"	5-1/8"
DB-1/2	DBDF-1/2	DBJDC-1/2	1/2"	4-1/2"	6"
DB-17/32			17/32"	4-13/16"	6-5/8"

SHEET METAL DRILLS - Double End Drill



High speed steel. 135° split point.
1/2 inch flute length. 12 Drills per package
COMPLETE DRILL KITS AVAILABLE ON REQUEST.
NUMBERED & LETTERED DRILLS AVAILABLE ON REQUEST.

PART #	SIZE	DECIMAL EQUIVALENT	OVERALL LENGTH
DBDED-1/8	1/8"	.1250"	2"
DBDED-3/16	3/16"	.1875"	2-3/16"
DBDED-1/4	1/4"	.2500"	2-1/2"

MECHANICS LENGTHS

PART#	SIZE	LENGTH
DBDFML-3/16	3/16"	3"
DBDFML-13/64	13/64"	3-1/8"
DBDFML-7/32	7/32"	3-1/4"
DBDFML-15/64	15/64"	3-3/8"
DBDFML-1/4	1/4"	3-1/2"
DBDFML-17/64	17/64"	3-5/8"
DBDFML-9/32	9/32"	3-3/4"
DBDFML-19/64	19/64"	3-7/8"
DBDFML-5/16	5/16"	4"
DBDFML-21/64	21/64"	4-1/16"
DBDFML-11/32	11/32"	4-1/8"
DBDFML-23/64	23/64"	4-3/16"
DBDFML-3/8	3/8"	4-1/8"
DBDFML-27/64	27/64"	4-7/16"
DBDFML-7/16	7/16"	4-1/2"
DBDFML-29/64	29/64"	4-5/8"
DBDFML-15/32	15/32"	4-3/4"
DBDFML-31/64	31/64"	4-7/8"
DBDFML-1/2	1/2"	5"

135° Split Point. Black and Gold finish with 3 flats to eliminate spinning in the chuck. Made from a premium grade of M-7 molybdenum high speed steel, which has a special black and gold surface treatment to increase lubricity and reduce friction. **Sold Individually.**



PART# DBDS-29DFML
3 Flat Straight Shank Drill Bit Set
29 Piece set. Black and Gold finish. 3-Flats to eliminate burrs on shaft. 3-Flats are only on 3/16" and larger. 1/16" - 1/2" sizes. **Sold Individually.**



REDUCED SHANK MECHANICS LENGTH DRILL BIT

135° Split Point. Black and Gold finish with 3 flats to eliminate spinning in the chuck. **3/8 Shank.** Made from a premium grade of M-7 molybdenum high speed steel, which has a special black and gold surface treatment to increase lubricity and reduce friction. **Sold Individually.**



PART#	SIZE	LENGTH
DBDFMLTS-25/64	25/64"	4-5/16"
DBDFMLTS-13/32	13/32"	4-3/8"
DBDFMLTS-27/64	27/64"	4-7/16"
DBDFMLTS-7/16	7/16"	4-1/2"
DBDFMLTS-29/64	29/64"	4-5/8"
DBDFMLTS-15/32	15/32"	4-3/4"
DBDFMLTS-31/64	31/64"	4-7/8"
DBDFMLTS-1/2	1/2"	5"

PART# DBDS-29DFMLTS
Reduced Shank Drill Bit Set
 29 Piece set. Black and Gold finish. **3/8 Shank.** 3-Flats are only on 3/16" and larger to eliminate burrs on shaft. 1/16" - 1/2" sizes. **Sold Individually.**

USS / SAE Tap & Drill Bit Size Table

Tap	Fractional Drill Bit	Number Drill Bit	Decimal Equiv.
0-80	3/64"	-	-
1-64	-	53	-
2-56	-	50	-
3-48	-	47	-
4-40	3/32"	43	-
5-40	-	38	0.1015"
6-32	7/64"	36	0.1100"
8-32	-	29	0.1360"
10-24	9/64"	25	0.1495"
10-32	5/32"	21	0.1590"
12-24	11/64"	16	0.1770"
1/4-20	13/64"	7	0.2010"
1/4-28	7/32"	3	0.2130"
5/16-18	17/64"	-	0.2570"
5/16-24	9/32"	-	0.2720"
3/8-16	5/16"	-	0.3125"
3/8-24	21/64"	-	0.3320"
7/16-14	23/64"	-	0.3680"
7/16-20	25/64"	-	0.3906"
1/2-13	27/64"	-	0.4219"
1/2-20	29/64"	-	0.4561"
9/16-12	31/64"	-	0.4844"
9/16-18	33/64"	-	0.5156"
5/8-11	17/32"	-	0.5312"
5/8-18	37/64"	-	0.5781"
3/4-10	21/32"	-	0.6562"
3/4-16	11/16"	-	0.6875"

Metric Tap & Drill Bit Size Chart

Tap	Metric Drill	Fractional Drill	Decimal Equiv.
3 mm x 0.5	2.5 mm	-	0.0984"
4 mm x 0.7	3.3 mm	-	0.1338"
5 mm x 0.8	4.2 mm	-	0.1693"
6 mm x 1.0	5.0 mm	-	0.2047"
7 mm x 1.0	6.0 mm	15/64"	0.2401"
8 mm x 1.25	6.8 mm	17/64"	0.2716"
8 mm x 1.0	7.1 mm	-	0.2795"
10 mm x 1.5	8.7 mm	-	0.3425"
10 mm x 1.25	8.8 mm	11/32"	0.3503"
10 mm x 1.0	9.0 mm	-	0.3583"
12 mm x 1.75	10.25 mm	-	0.4133"
12 mm x 1.5	10.7 mm	27/64"	0.4212"
14 mm x 2.0	12.0 mm	-	0.4999"
14 mm x 1.5	12.5 mm	1/2"	0.5039"
16 mm x 2.0	14.0 mm	35/64"	0.5590"
16 mm x 1.5	14.5 mm	-	0.5787"

H12



INSERT AND POWER BITS

MAGNETIC NUTSETTER (For Driving Hex Head Screws)



HEX MAGNETIC CHUCKS	PART #	OUTSIDE DIAMETER	OAL	HEX OPENING
 <p>¹Extra Long</p>	HMC14	7/16"	1-3/4"	1/4"
	HMC516	1/2"	1-3/4"	5/16"
	HMC516L ¹	1/2"	2-9/16"	5/16"
	HMC38	9/16"	1-7/8"	3/8"
	HMC38L ¹	9/16"	2-9/16"	3/8"
	HMC716	5/8"	1-7/8"	7/16"

HEX MAGNETIC BIT HOLDERS	PART#	OAL	DESCRIPTION
	MBH-1/4	3"	Heavy Duty
	MBH-1/4X6	6"	Extra Heavy Duty

WITH 1/4" HEX SHANK

FOR PHILLIPS SCREWS	PART #	DESCRIPTION	OAL	POINT SIZE
	PMC-1	For #2, 3, 4 Screws	1"	1
	PMC-2	For #5, 6, 8, 10 Screws	1"	2
	PMC-3	For #12, 14 Screws	1"	3
	PMC-1XXL	For #2, 3, 4 Screws	1-1/2"	1
	PMC-ACR2L	For #5, 6, 8, 10 Screws	1-15/16"	2
	PMC-2L	For #5, 6, 8, 10 Screws	1-15/16"	2
	PMC-2XL	For #5, 6, 8, 10 Screws	2-3/4"	2
	PMC-2XXL	For #5, 6, 8, 10 Screws	3-1/2"	2
	PMC-2XXXL	For #5, 6, 8, 10 Screws	6"	2
	PMC-3L	For #12, 14 Screws	2"	3
	PMC-3XXL	For #12, 14 Screws	3-1/2"	3
PMC-3XXXL	For #12, 14 Screws	6"	3	

LIMITED CLEARANCE BITS	PART#	DESCRIPTION	OAL	POINT SIZE
	PMCN-2	For #5, 6, 8, 10 Screws FOR REDUCED DIAMETER HEADS	1"	2

FOR SQUARE RECESS SCREWS	PART #	DESCRIPTION	OAL	POINT SIZE
	SMC-1	For #5, 6, 7 Screws	1"	1
	SMC-2	For #8, 10 Screws	1"	2
	SMC-2L	For #8, 10 Screws	1-15/16"	2
	SMC-3L	For #12, 14 Screws	1-15/16"	3
	SMC-2XL	For #8, 10 Screws	2-3/4"	2
	SMC-3XL	For #12, 14 Screws	2-3/4"	3
SMC-2XXXL	For #8, 10 Screws	6"	2	

TORX DRIVE BIT	PART#	DESCRIPTION	OAL
	TMC-15	For #6 Screws	1"
	TMC-20	For #8 Screws	1"
	TMC-25	For #10 Screws	1"
	TMC-27	For #12 Screws	1"
	TMC-30	For #14 Screws	1"
	TMC-40	For 5/16" Diameter Screws	1"
	TMC-15L	For #6 Screws	1-15/16"
	TMC-20L	For #8 Screws	1-15/16"
	TMC-25L	For #10 Screws	1-15/16"
	TMC-30L	For #14 Screws	1-15/16"
TMC-40L	For 5/16" Diameter Screws	1-15/16"	

ALKALINE BATTERIES



PART#	SIZE	PKG
FLT-BAT-9V8	9Volt	8 / Pack
FLT-BAT-AA24	AA	24 / Pack
FLT-BAT-AAA24	AAA	24 / Pack
FLT-BAT-C12	C	12 / Pack
FLT-BAT-D12	D	12 / Pack



PART# FLT-BAT-123A
123A Lithium Battery 3Volt
1/Card. Long-Lasting
quality. **Sold Individually.**

LANTERN BATTERIES



PART# FLT-BAT-6VL
6 Volt

Rayovac Lantern Batteries are engineered for rugged applications providing reliable lighting for a variety of uses. **Sold Individually.**

ROUGH SERVICE BULBS

Ideal for all shop uses. Withstands shock and vibration. Brass base eliminates corrosion and freezing in socket. Plastic coating protects products and personnel from shattered glass.

PART#	TYPE	WATTS	STANDARD PKG		
			VOLTS	PER PKG	PER CASE
J-RS50	Rough Service	50	120	6	120
W-RS60	Rough Service	60	120	6	120
W-RS75	Rough Service	75	120	6	120
W-RS100	Rough Service	100	120	6	120
J-TS75	Tough Skin*	75	120	6	120

* Plastic Coated



**TOUGH SKIN
BULB**



**ROUGH SERVICE
BULB**

MASTER ULTRATANE BUTANE



Triple-refined formula reduces clogging of filters. Special vapor pressure promotes consistent ignition. Contains no CFC's. Canister includes single-piece universal filling tip. Recommended refill for all Ultratorch® & Master Butane-powered products. **Sold Individually.**

PART#	SIZE	DELIVERY INSTRUCTIONS
MA-10448	15/16oz	Can be shipped UPS.
MA-51773	5-1/8oz	Contact your salesperson for delivery.

REFILLABLE BUTANE MICRO TORCH



PART# MA-MT51

Open flame torch. May be hand-held or used hands-free on table top. Built-in self-igniting system with safety lock that ensures the switch is not turned on when not in use. Built-in, refillable plastic fuel tank. Wide stable base is perfect for hands-free use. Temperature up to 2500°F/ 1300°C with open flame; 932°F/500°C with hot air tip. 2-hour continuous run time for perfect continuous heat applications. Adjustable flame that will produce a broad or pinpoint flame. Meets Consumer Products Safety Commission (CPSC) requirements. Use to heat materials, ignite materials, pinpoint torch, shrink tubing, solder and desolder, terminate specialty connectors and more. **Sold Individually.**

BOOSTER CABLE HANDLES



PART# 50A
50 Amp. Insulated Steel Handles with copper plating. Cushion grips. 1" Jaw spread. 3-1/4" length.
1 Red and 1 Black / Set



PART# 400A
400 Amp. Insulated steel, vinyl coated handles. For use on side mount or standard top post battery. Cable hooks directly to jaws for positive connection. 1" Jaw spread. 7" length.
1 Red and 1 Black / Set



PART# 500A
500 Amp. Parrot-type steel extra heavy duty handles with serrated jaws. Zinc plated. 1-1/2" Jaw spread. 6" length.
1 Red and 1 Black / Set



PART# 800A
800 Amp. Heavy Duty fleet and farm equipment handles, with strain relief and pure copper jaws. 1-1/2" Jaw spread. 7" length.
1 Red and 1 Black / Set
PART# 800B Black Only
PART# 800R Red Only

BATTERY CHARGING CLIPS

High Quality Copper or Steel Clips.
Great for test lead hook ups and charging batteries.



FIGURE 1



FIGURE 2

PART#	AMP	FIG	METAL	JAW SPREAD	LENGTH (INCHES)	STD PKG
692C	10	1	Steel	5/16"	1-31/32"	10
693C	10	1	Copper	5/16"	1-31/32"	10
694C	10	2	Copper	1/2"	2"	10
695C	25	2	Copper	3/4"	1-31/32"	5
696C	50	2	Copper	1-1/16"	4-7/64"	1

PROTECTIVE BOOTS

Rubber Insulated for Clips



FIGURE 3



FIGURE 4

RED PART#	BLACK PART#	FIG	STD PKG	USE WITH
693R	693B	3	5	692C
693R	693B	3	5	693C
694R	694B	4	5	694C
695R	695B	4	1	695C
696R	696B	4	1	696C

IGNITION WIRE AND ENDS



PART# SPN-SIL
Straight silicone spark plug protector.
Standard Package 25



PART# SPN-SIL-90
90° silicone spark plug protector.
Standard Package 25



PART# DC-7
Distributor Clip for copper wire. **Standard Package 100**



PART# SPW-C
Hypalon insulated 7MM ignition cable with a copper conductor. Black in color. Unaffected by oil, grease or moisture and operates well between the temperatures of -65° F to +300° F. **100 Foot Spools.**

PORTABLE DROP LIGHT

PART# EXTDL-16/3-25MC
Portable drop light
UL listed. High impact handle with 3-prong receptacle. Metal guard. Rugged PVC-coated 16ga, 3-conductor cable. For indoor use only. **Sold Individually**



EXTENSION CORD ENDS



PART# 3WF-110V
Female Receptacle

110 Volts -
15 Amp



PART# 3WM-110V
Male Plug



PART# 3WF-1610C
Female Receptacle

ERICSON
125 Volts -
15 Amp



PART# 3WM-1510P
Male Plug

QUICK INDEX SECTION J

J1

Chemicals

J2-4 Dynatex Products
 J5-6 3M Products
 J7 Seymour Products

J8 McKanica Products and Grote Chemicals
 J9 B'Laster Products, Noco and Deka



RTV SILICONE SEALANT



PART# DYN-49289
Clear Marine Grade

Designed for use in marine applications. Silicone Sealant is used for sealing windshields, doors, windows and wires, around steering cables, depth finder wires, horn assemblies, gauges, marine antenna bases, attaching screws, rail mounts and other locations where hull has been penetrated. Resists shrinkage. Seals and bonds metal, plastic, wood, glass, fiberglass, vinyl and fabric. Cures at room temperature. **11oz Cartridge. 12 per case.**

Industrial Grade

General purpose high quality 100% RTV Silicone Sealant. Cures at room temperature to a tough and flexible rubber. For caulking, sealing, waterproofing and bonding. Seals and bonds terminals, connectors, mounting fixtures, mechanical gaskets, glass, metal, masonry, plastic, tile, rubber, wood and fabric. DYN-49285 is manufactured to meet USDA approval. **11oz Cartridge. 12 per case.**

PART#	DESCRIPTION
DYN-49285	White cartridge
DYN-49286	White cartridge - Mildew Resistant



CLEAR RTV SILICONE ADHESIVE / SEALANT

Provides transparent, watertight silicone rubber seal for a wide range of application. Bonds and seals metal, plastic, glass, fabric, vinyl, wood and rubber. Use on windshields, sunroofs, tail lights, interior panels, fire walls and dashboards. Cures at room temperature. **12 per case.**



PART#	SIZE
DYN-49204	3oz Tube carded
DYN-49274	8oz Automatic can
DYN-49280	11oz Cartridge

BLACK RTV SILICONE GASKET MAKER - L/V

Formulated for gasket making applications. Sensor safe and manufactured to meet OEM specifications. Makes instant, leak proof gaskets for all engines, drive train equipment and related components. Temperature resistant up to 500°F (260°C). Resists oil, water, anti-freeze and transmission fluid. Cures tough and flexible. Works on all vehicles. **12 per case.**



RED RTV SILICONE GASKET MAKER - L/V

Formulated to withstand higher operating temperatures. Sensor safe and manufactured to meet OEM specifications. Resists cracking, shrinking and migration caused by thermal cycling. Will not leak. Temperature resistant up to 650°F (343°C). Resists oil, water, anti-freeze and transmission fluid. **12 per case.**

PART#	SIZE
DYN-49202	3oz Tube carded
DYN-49272	8oz Automatic can

PART#	SIZE
DYN-49200	3oz Tube carded
DYN-49271	8oz Automatic can
DYN-49290	11oz Cartridge



PART# DYN-49442
Boltlocker Blue Medium Strength (Threadlocking)
Fills gaps up to .006 inches. Apply prior to assembly. Eliminates need for stocking lock nuts and lock washers. Can be removed without special tools. **24 ml Bottle Carded. 6 per case.**

PART# DYN-49203
Blue RTV Silicone Gasket Maker L/V
Replaces most cut gaskets. Sensor safe and manufactured to meet OEM specifications. Resists cracking, shrinking and migration caused by thermal expansion. Cures tough and flexible. Temperature resistant up to 500°F (260°C). Resists oil, water, anti-freeze and transmission fluid. For valve covers, oil pans, transmission pans, rear-end housings, timing chain covers, thermostat housings, water pumps and oil pump flanges. **3 oz Tube Carded. 12 per case.**



PART# DYN-49452
Boltlocker Red High Strength
Locks and seals metal threaded assemblies where high strength is required. Fills gaps up to .008 inches. Apply prior to assembly. Protects against thread corrosion. **24 ml Bottle Carded. 6 per case.**

RED & BLUE THREADLOCKER GEL

Anaerobic threadlocking material, which cures between engaged threads to form a unitized assembly that resists virtually all leakage, shock and vibration. Threadlocker gel comes in a pump dispenser. Ideal for all 1/4 inch to 1 inch diameter nut and bolt assemblies where future disassembly is improbable. Excellent chemical resistance with a temperature resistance range of -65°F to 350°F (-54°C to 177°C). Fixture tight in minutes. Protects against thread corrosion. **6 per case.**

PART#	DESCRIPTION
DYN-49446	Blue Medium Strength
DYN-49456	Red Super Strength



RTV: Room Temperature Vulcanizing

L/V: Low Volatile

CHOKE AND CARB CLEANER



PART# DYN-52105
Helps remove varnish, gum, sludge and other deposits in minutes. Improves performance. Use on carburetors, automatic chokes, PCV systems and heat risers. VOC-Compliant. Contains no CFCs. Oxygen sensor safe. Flammable. **16oz Aerosol can. 12oz net wt. 12 per case.**

Dynatex®

BRAKE CLEANER



Quickly removes grease, oil and brake dust from brake system components. Leaves no residue. Fast acting. Use on drums, rotors, master and wheel cylinders, shoes, and linings, pads, hardware, back plates, linkages and calipers. Safe for use on aluminum. Does not contain chlorinated solvents. Flammable. **12 per case.**

PART#	SIZE
DYN-49665	20oz Aerosol can
DYN-49670*	5 Gallon / 19L

* Cannot be shipped UPS

RUBBER UNDERCOAT



PART# DYN-52175
Seals, protects and insulates. To prevent rust and deaden sound. Undercoat leaves a firm, black, resilient, rubbery texture, which protects against rust and corrosion. Paintable. Quiets road noise. Also for wood fences, post preserver and tree wound dressing. Adheres to any surface. **20oz Aerosol can. 16oz net wt. 12 per case.**

ENGINE DEGREASER



PART# DYN-52165
Quickly removes grease, oil, dirt and other contaminants. Works on steel, aluminum, copper and other metals. Safe for use on rubber and plastic. Can also be used on driveways and garage floors. **20oz Aerosol can. 16oz net wt. 12 per case.**

GASKET REMOVER



PART# DYN-49673
Quickly removes baked-on gaskets, silicone, weatherstrip adhesive, carbon deposits, dried oil, adhesives, grease and paint. Removes gaskets in 10-12 minutes. Prepares metal parts for new gasket installation. **16oz Aerosol can. 12oz net wt. 12 per case.**

SILICONE SPRAY



LUBRICANT
PART# DYN-52115
A dry film lubricant which waterproofs, protects, reduces corrosion, lubricates and extends life of rubber and plastic parts. Suitable for metal, plastic, rubber, vinyl, leather and wood. Active ingredients comply with FDA and USDA regulations. **16oz Aerosol can. 10.25oz net wt. 12 per case.**

RED GREASE



PART# DYN-49611
Multi-purpose lubricant provides extra protection under extreme pressure and temperatures from 0°F to 400°F. Excellent water resistance makes it ideal for machinery operating in damp environments. Also for use on bearings, automotive hinges, hitches, fifth wheels, cables, pulleys and chains. **16oz Aerosol can. 11oz net wt. 12 per case.**

WHITE LITHIUM GREASE



PART# DYN-49596
General-purpose lubricant. Protects against rust and corrosion. Minimizes friction. Reduces wear to equipment. Increases service life. Can be used on door, hood and trunk latches. Hinges and compartment springs, seat regulators and tracks, wiper mechanisms, brake parts and distributor cams. Manufactured to meet USDA specifications. **16oz Aerosol can. 10.5oz net wt. 12 per case.**

THREAD SEALANT WITH PTFE



PART# DYN-49494
All-purpose thread sealant. Seals threaded connections for air, oil, diesel fuel and hydraulic oil. Remains pliable. Temperature ranges -65°F to 300°F. Performs better than tapes. Withstands pressures up to 10,000 psi. PTFE is Polytetrafluoroethylene, commonly known as Teflon. **16oz Brush top bottle. 12 per case.**

ELECTRICAL PARTS CLEANER



PART# DYN-52145
Quickly dissolves and flushes away grease, oil, dirt and other contaminants while leaving no residue. Use on air conditioning equipment, electric motors, alternators, starting motors, cables, controls, regulators, relays, signals, solenoids, electrical contact points, connections, air compressors, battery chargers and more. Not safe for use on rubber or plastic parts. **16oz Aerosol can. 12oz net wt. 12 per case.**

CONTACT CLEANER



PART# DYN-52146
Removes grease, dirt, oil and other surface contaminants from electrical/electronic devices. Fast drying, leaves no residue and cleans easily. Safe on most surfaces. Extremely Flammable. **16oz Aerosol can. 12oz net wt. 12 per case.**



ANTI-SEIZE & LUBRICATING COMPOUND

Prevents carbon fusion and seizure up to 2000°F (1093°C). Protects against corrosion between dissimilar metals. Resists water, salt solution, most shop and automotive fluids. Reduces coefficient of friction by a minimum of 20%. Meets MIL-907 specifications.



PART#	SIZE	CASE QTY
DYN-49550	4oz Brush top bottle	24 per case
DYN-49558	8oz Brush top bottle	12 per case
DYN-49560	16oz Brush top bottle	12 per case
DYN-49576	16oz Aerosol can	12 per case
DYN-49582	8oz Copper Brush top bottle*	12 per case

* Contains copper

DIELECTRIC GREASE

Prevents boot tears, corrosion, arcing and the fusing of spark wires to spark plugs. Maintains its consistency in extreme temperatures from -40°F to 400°F. Resists moisture, acids and alkalines. Moisture proof seal for automotive, marine and other ignition and electrical systems. For distributor caps, battery cables, posts and terminals, light bulb sockets, trailer hitch and all other types of electrical connectors. Complies with FDA Regulation 21 CFR178.3570. **12 per case**



PART#	SIZE
DYN-49634	1/3oz Tube carded
DYN-49635	5oz Tube boxed

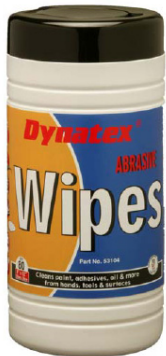

ABRASIVE WIPES

PART# DYN-53104
Industrial Abrasive Wipes clean paint, adhesive, oil and more from hands, tools and surfaces. To assist removal of dry paint, place wipe on spill for a few minutes to soften paint. Removes silicone, acrylic, fillers, poly adhesive, poly foam, epoxy, rubber cement and label residue. Removes oil, grease, ink and more. Ideal for stain and grease removal from most work surfaces. 12" x 8" wipes. **80 / Tub. 8 per case.**



BRUSH-ON ELECTRICAL TAPE

PART# DYN-49412
Forms a tough, flexible black coating that seals out moisture and corrosion. Adheres to metal, rubber, vinyl and plastic. Dries at room temperature in 5 minutes. **4oz Brush top can. 12 per case.**



SUPER GLUE

PART# DYN-49403
Instantly bonds glass, metal, plastics and rubber. Bonds close fitting parts in seconds. Works on aluminum, copper, brass, steel, vinyl, PVC, polyester, nylon, fiberglass and wood. Holding strength to 5000 psi. **2g Bottle carded. 12 per case.**



SUPER GLUE GEL

PART# DYN-49433
Fast and strong repairs. Works on vertical surfaces - will not run. Extra strength formula bonds rubber, vinyl, most plastics, glass, leather, cork and more. **2g Tube carded. 12 per case.**



REAR VIEW MIRROR ADHESIVE

PART# DYN-49401
Permanently bonds rear view mirror bracket to windshield. Strong and fast acting. No Mixing. Two part formula-adhesive and primer. Bond strength to 3000 psi. **.3ml Pillow packet with primer, carded. 12 per case.**

HIGH STRENGTH SPRAY ADHESIVE **3M**



PART# 3M-00090

A high strength, fast drying, contact-type adhesive used for permanently bonding decorative laminates, particle board, wood, metal, many plastics including polyethylene and propylene, foam, concrete and many other materials. Convenient, fast, high contact-bond strength, low soak-in keeps more adhesive on the surface to provide better coverage. High heat resistance maintains bond strength even after extended exposure to heat. Precise spray control and variable spray width makes it easy to apply. **16oz Aerosol can. 12 per case.**



SUPER 77™ SPRAY ADHESIVE

PART# 3M-21210

Super 77™ Multipurpose Spray Adhesive is a high tack and fast drying mist spray adhesive. Bonds quickly in 15 seconds. Securely bonds many lightweight materials such as attaching foils, carpeting, lightweight paper, cardboard, felt, and cloth to painted or unpainted metals and wood. **16.75 oz. net wt., contains 24 fl. oz. 12 per case.**



SPRAY TRIM ADHESIVE CLEAR

PART# 3M-08074

An adhesive for attaching lightweight trim materials (upholstery cloth, trunk liners) to metal and other surfaces. Ideal for position bonding applications where mechanical fasteners will be used. **May be used to bond polystyrene foam. 24 fl. oz Aerosol. 6 per case.**



GENERAL TRIM ADHESIVE CLEAR

PART# 3M-08088

A low VOC, high-strength adhesive for bonding automotive materials (carpeting, jute pads, fabrics, plastics) to metal and other surfaces. Good heat and water resistance. **Not recommended for bonding polystyrene foam. 16.25 fl. oz Aerosol. 4 per case.**



SUPER TRIM ADHESIVE

PART# 3M-08090

A contact adhesive designed for bonding vinyl tops, heavyweight headliners and hood silencer pads where high strength and heat resistance are needed. **18oz Aerosol can. 6 per case.**



SUPER WEATHERSTRIP ADHESIVE

Bonds all types of gaskets to painted or unpainted metal surfaces. Adhesive stays permanently flexible and rubbery, never dries out or becomes hard. Easy to brush and spread. Extremely fast drying. Exceptional bonding strength, waterproof and flexibility (rubbery). Resists oil, grease and solvents. **6 per case.**

PART#	COLOR	TUBE SIZE
3M-08001	Yellow	5 oz
3M-08008	Black	5 oz

SUPER WEATHERSTRIP ADHESIVE BLACK

PART# 3M-08011

Fast-drying black adhesive used for bonding and sealing weather stripping. Also an excellent adhesive for new EPDM weather stripping. Easy to apply. Remains flexible. Waterproof. **5oz Tube. 6 per case.**



SCOTCH™ SILICONE LUBRICANT



PART# 3M-SIL

Lubricates, protects and is **USDA listed**. Use on tuners and switches, plastic gears and drives, locks and hinges, drawer guides and other sliding parts. Works against squeaks caused by friction and helps to relieve sticking and seizing. Inhibits rust and corrosion, resists moisture, helps preserve plastic, rubber and leather materials. Impedes buildup of glues, waxes, inks, paints, etc. Reduces friction when cutting tools are used. A silicone polymer, this product contains no petroleum oils, will not freeze at -28°F or degrade at 350°F. **15.5 Fl oz. 12 per case.**



RUBBERIZED UNDERCOATING BLACK

PART# 3M-08881

Black, multi-purpose, low cost, aerosol undercoating. Specifically used for undercarriages, wheel wells, frame rails and fenders. Designed to protect metal from corrosion and abrasion. Can also be used as a sound dampening coating. **16oz Aerosol Can. 6 per case.**

WHITE GREASE (Lithium Lube)

PART# 3M-08875

Long-lasting lubrication. Easy spray viscosity. No solvents to wash off. Won't drip or run. Resists "washing out" if exposed to road spray. Convenient, cost-effective. **10.5 oz Aerosol. 12 per case.**



SILICONE LUBRICANT DRY TYPE



PART# 3M-08897
 3M™ Spray Silicone Lubricant is an aerosol designed for a variety of applications. It is used for moving parts, eliminating squeaks caused by friction; protecting against rust and corrosion; sealing out moisture; preventing buildup of glues, waxes, inks, paints, etc.; preserving plastics, rubber, leather and prolonging the life of cutting tools. It does not contain petroleum oils. It will not stain or become gummy. **16oz Aerosol. 12 per case.**

SUPER SILICONE SEALANT CLEAR



PART# 3M-08661
 3M™ Super Silicone Adhesive/Sealant is a paste-like, one-component material which cures to a tough, rubbery solid when exposed to moisture in the air. It will adhere to clean metal, glass, wood, ceramic, natural and synthetic fiber, painted surfaces and many plastics. It is easy to use and exhibits excellent resistance to weathering, vibration, moisture, ozone and extreme temperatures. **3oz Tube. 12 per case.**



4-WAY SPRAY LUBRICANT

PART# 3M-08898
 Specialized formula for general use. Provides characteristics of a lubricating oil, a penetrating oil, a demoisturizing coating and a thin bodied, transparent rust preventative coating in aerosol form. **16oz Aerosol. 12 per case.**



SUPER FAST URETHANE - BLACK

PART# 3M-08609
 One part moisture curing urethane adhesive that bonds auto replacement glass to car bodies. A medium viscosity, single component, moisture curing urethane adhesive. Bonds replacement auto glass to car bodies. Thick bondline may allow some non-structural body panel applications. **10 fl oz cartridge. 12 per case.**

HIGH POWER BRAKE CLEANER VOC COMPLIANT (Non-Chlorinated)



PART# 3M-08180
 A high delivery **non-chlorinated** general purpose degreaser. Designed to remove oil, grease, brake fluid and other contaminants from all types of brake assemblies and parts without disassembling the unit. Contains no ozone depleting ingredients. Leaves no residue and helps eliminate disc brake squeal and chatter. **14oz Aerosol. 12 per case.**



2.5CC 3M™ AUTO ADHESION PROMOTER

PART# 3M-06396
 This adhesion promoter is a liquid primer used for most low surface energy plastics, such as automotive dash and interior trim applications. 3M™ adhesion promoter is specifically formulated to be used with 3M™ acrylic foam tape for automotive applications. Since formulations and surface energies can vary for these types of materials, each application should be verified through testing. Supplied in an easy-to-use sponge applicator packet. Not to be stored above 80°F. **25 packets per box. 4 Boxes per case**

UNIVERSAL FUEL SYSTEM KIT



PART# 3M-08911
 Universal fuel system kit 120PSI. 1 can 3M™ universal fuel system cleaner, 1 bottle 3M™ fuel system cleaner tank additive and 1 can 3M™ throttle plate cleaner. **6 per case.**



FUEL SYSTEM CLEANER TANK ADDITIVE

PART# 3M-08813
 A tank additive that cleans fuel injectors, intake valves and combustion chambers. Improves fuel economy and power. Removes carbon, gums, resins and varnish. For gasoline engines only. **16 fl oz bottle. 6 per case.**

GLASS CLEANER

PART# 3M-08888
 An aerosol cleaner for all glass surfaces including windows, windshields, mirrors and side glass. May also be used to clean automotive vinyl, interior plastic and clear plastic. It's non-flammable, and will not affect painted surface. Easy to use, quick acting, non-streaking aerosol cleaner that is also effective for use on chrome and metal. **19 oz Net Wt. 12 per case.**





"NOT JUST A PAINT COMPANY"



MRO INDUSTRIAL COATINGS

High Solids Industrial Protective Coatings

Maintenance Repair Operations (MRO) paints are excellent for most types of wood and metal such as: blowers, benches, machinery, racks, fire doors, sprinkler systems, bins, motors, tanks and piping. **Protects** against rust, weather, oil, gasoline and most corrosive chemicals. **Single coat hiding.** Abrasion and heat resistant. For maximum protection, prime bare or rusted metal surfaces with appropriate MRO Primers. MRO is **SAG resistant.** 16 oz can. 6 per case.

PART#	COLOR
SE-620-1415	Gloss Black
SE-620-1418	Gray
SE-620-1433	Flat Black
SE-620-1431	Light Gray Primer
SE-620-1407	Red Iron Oxide Primer
SE-620-1413	Gloss White
SE-620-1443	New Cat Yellow
SE-620-1423	Gloss Red
SE-620-1450	Omaha Orange

Ask about other available colors.



FARM AND INDUSTRY ENAMEL

PART# SE-16-286
SCHOOL BUS YELLOW

A heavy duty farm tractor and implement paint that is available in many popular manufacturer colors. This high solids formulation has excellent hiding qualities, protects against fading, and is heat and gas resistant. For maximum protection, a primer is recommended. Used for restoring antique tractors. Touch up rusted areas. Other colors available include Caterpillar, John Deere, Allis Chalmers, International Harvester and Case machinery. 12 oz can. 6 per case.



GOOD GRIP™ SLIP RESISTANT CLEAR COATING

PART# SE-16-81

Seymour's slip resistant coating is an ideal choice to reduce accidents that happen on slick surfaces. Good Grip is an easy to use aerosol that applies a textured coating to almost any surface. Good for **Auto:** running boards, grab bars, truck beds & ramps. **Home:** stairs, hand tools & pool areas. **Lawn & Garden:** garden tractor steps & tool handles. **Marine:** boat decks, piers & ladders. 12 oz can. 6 per case.

DRY GRAPHITE AND DRY MOLY LUBE



Dry Moly is a quick-drying, thin film that provides superior lubrication under extreme pressures and a broad temperature ranges. Excellent adhesion, oil free and protects against seizing, fretting and galling. Provides excellent anti-wear protection for cutting and forming tools. Extension tube provided for pinpoint application. Dust free lubricant for pre-assembly and production, wire drawing, gasket and stop-off coating, rubber mold release, machine tool slides and conveyors (hi-temp.) **Dry Graphite** is a fast drying graphite lubricant that reduces friction and noise. Effective under heavy pressures and high temperature extremes. The oil-free formulation resists water and alkalis. The all position valve allows spraying in any position. May be used as a parting compound on dies, sand cores or match plates. Used for bearings, tracts, conveyors, flat springs and hinges. 12 oz Can. 6 per case.

PART#	COLOR
SE-620-1505	Dry Moly Lube
SE-620-1506	Dry Graphite Lube



OPEN GEAR LUBE

PART# SE-620-1501

Increases life of gears and improves gear's efficiency. Protects against rust and corrosion. Performs under extreme temperatures and pressures. Will not wash or weather away. An extension tube is furnished for pinpoint application. Unaffected by salt water, detergents and most chemicals. It will not dry out and leave harmful deposits. 15 oz can. 6 per case.



TOOL CRIB TOOL CUTTING OIL

PART# SE-620-1557

For all types of metal cutting, drilling, tapping and threading. Use on gear-cutting tough metals such as stainless steel, Inconel™, titanium and Chromalloy™. Resists run off or breakdown. Eliminates scoring and chatter marks. Prolongs tool life and cutting edge. Prevents rust on newly machined parts. Reduces rejects. Extension tube furnished for pin point application. Transparent on the surface. 18 oz Can. 6 per case.



ZINC PHOSPHATE PRIMER

PART# SE-16-899

Excellent for priming both aluminum and ferrous metals. Used in truck and automotive fleets, industrial, aeronautical and marine industries. Ideal for spot repair of damaged coatings. Overspray is reduced. Exceptional protection against rust and corrosion. Resists corrosion from seacoast exposure. Very effective with two component coatings. Does not contain chlorinated solvents. Lead free. 12 oz Can. 6 per case.



BENEFITS OF McKANICA®

- * Finger tip control
- * Control lever can be locked to prevent accidental discharge and stops sealant from hardening in the can.
- * No waste, 100% usage of the product.
- * Nozzle has a cap to help prevent product from setting up in the end of it, but if product does, the nozzle can be taken off and cleaned or replaced.

MAX SILICONE SEALANT



PART#	COLOR
MCK-0310	Gray
MCK-0312	Copper

A high temperature specially formulated silicone sealant to perform under extreme temperatures up to 700°F (371°C) intermittent. The high build formulation is specially formulated for non-corrosive application to aluminum, low odor and suitable for all gasket applications (not head gaskets or exhaust manifolds). Oxygen sensor safe. Exceeds OEM specs. Resists oil, water and antifreeze mixture. **6.7 fl oz. 200ml. 6 per case.**

SEAM SEALERS



PART# MCK-0325

Ideal for use on all types of body seams and is paintable once dried. **School Bus Yellow** is a new formulation from McKanica® for repairing school buses in matching color. Paintable within one hour. Polyurethane based. Remains flexible. Excellent adhesion to bare or primed metal. **6.7 fl oz. 200ml. 6 per case.**

DIELECTRIC TUNE-UP GREASE



PART# MCK-0329

McKanica® Dielectric Tune-up Grease is new technology and is a high temperature silicone based lubricant for use in high energy, ignition-equipped vehicles. Protects electrical connections, ignition parts and wiring from corrosion, moisture and dirt. Required protection in spark plug or spark plug wire replacement on all modern vehicles and prevents spark plug boot damage. Exceeds OEM specs on high energy ignitions. **6.7 fl oz. 200ml. 6 per case.**



SILICONE SEALANT AUTO/MARINE

PART#	COLOR
MCK-0298	High Red
MCK-0300	Black
MCK-0302	Clear
MCK-0304	Blue
MCK-0314	White

McKanica® Silicone Sealant flows easily under pressure control and resists temperatures up to 650°F (343°C). The sealant bonds all types of joints and replaces gasket material including rubber, paper, felt and cork, (unsuitable for head gaskets). It is oxygen sensor safe and has many uses: water pumps, valve covers, oil pans, intake manifolds, transmission pans, cam covers, water neck outlet, windshields, sun roofs and any waterproofing job. Use on all engines. Resists oil, water and antifreeze mixture. **6.7 fl oz. 200ml. 6 per case.**

ULTRA-SEAL CORROSION PREVENTATIVE SEALANT



PART#	SIZE
GR-99170	4oz Tube
GR-99180	8oz Tub

Prevents rust and corrosion. Good mechanical stability. Added tackifiers improve adhesion and resistance to washout. Cost-effective, corrosion preventative sealant. Has a 25% higher non-conductivity rating compared to the competition. Operating range -40°C to 150°C (-40°F to 302°F).





PENETRATING CATALYST

Powerful, concentrated penetrant loosens rusted, warped and frozen parts. Breaks loose surface tension of rust and corrosion quickly by creeping up, around and into all hard-to-reach cavities. Lubricating film stays on part to help prevent further rusting or freezing.



PART#	SIZE	CASE QTY
PB-16	12oz Aerosal can	12 per case
PB-128	1 Gal Can (Bulk)	4 per case

AIR TOOL OIL / CONDITIONER

Restores and prolongs air tool life by cleaning, coating and lubricating while tools are in use. Instantly removes built-up calcium, varnish, sludge and water. Inhibits rust and increases RPMs. **12 per case.**



PART#	SIZE
PB-ATC-404	16oz Aerosal can
PB-ATC-4	4oz Bottle

SILICONE LUBE

PART# PB-SL-16

Rich in silicone to lubricate, preserve and protect a wide variety of surfaces. Spray on dry to prevent sticking, binding and squeaking. Safe, non-staining lubricant is ideal for use where chlorinated solvent-based products may be too harsh. Great for RV windows. **11oz can. 12 per case.**



CITRUS DEGREASER

PART# PB-CBD-16

Fast acting, super penetrating cleaner / degreaser handles a wide variety of the toughest maintenance jobs. Removes extremely heavy-duty greases and oils, resins, printing inks and wet paints; strip and remove wax. **11oz can. 12 per case.**



SQUEAKY CLEAR GLASS CLEANER

PART# NO-E800

Contains ammonia and fragrant aroma and is fast acting with no streaking. Cleans windows, mirrors, chrome, enamel, finger prints, stainless steel sinks, stoves, bath tile, refrigerators, porcelain, woodwork, vinyl upholstery, table and counter tops. Removes bugs. **16 oz can. 12 cans per case.**



FELT BATTERY PROTECTORS

PART# NO-NCP2TM

Top Mount. 5/8" I.D. Impregnated felt protectors for battery terminals stops corrosion caused by acid fumes. NCP-2 compound lasts indefinitely without drying or evaporating. Large outside diameter protectors. **50 per can**

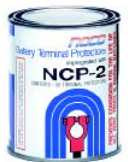

BATTERY CORROSION PREVENTATIVE SPRAY

PART# NO-A202

Spray battery cables, posts, hold downs and carriers to form impregnable barrier to corrosion causing acid fumes. Easy and safe to use, contains no fluorocarbons. **12.75 oz can. 12 per case.**



SPRAY BATTERY CLEANER

PART# NO-E403

Works instantly to neutralize acid, dissolve and remove power robbing corrosion from terminals, cables, hold-downs and boxes. Ideal for all batteries – automotive, marine, aircraft and industrial. **14 oz can. 12 per case.**



BATTERY PROTECTION SPRAY

PART# EP-647

Protects terminals while fighting battery corrosion and prolonging the battery life. **10oz can. 12 per case.**



BATTERY CLEANER SPRAY TOP POST BATTERY TERMINAL PROTECTOR

PART# EP-648

Cleans terminals while it penetrates, loosens and neutralizes all acid corrosion deposits. **10oz can. 12 per case.**



PART# EP-643

Terminal protectors extend the life of batteries and terminals. Helps prevent corrosion. **100 per can.**

QUICK INDEX SECTION K

K1

Brass Fittings / Grease Fittings / Air Couplers and Plugs

- K2** Air Brake Nylon Tube Fittings, Push to Connect Air Brake Fittings
- K3** Brass Pipe Fittings and Inverted Flares
- K4** Standard Compression Fittings, 45° SAE Flare, Air Line Hose Barbs, Ground Key Shut-Off Cocks, Push on Fittings
- K5** Brass Fittings Chart
- K6** Hydraulic Grease Fitting Couplers, Quick Disconnect Couplers and Plugs
- K7-8** Air Couplers and Plugs Chart



K2



K3



K4



K6

BRASS PART NUMBERING INSTRUCTION

How to figure out our brass part numbers. The first digit of C refers to the manufacturer, Coronet Manufacturing. The number after the first dash refers to the style or type of fitting. Each has its own unique number. The number after the 2nd dash refers to the **sizes** of the fitting in 1/16's. A number 4 is 4/16 or 1/4. The table to the right shows the fractional size with the corresponding number.





Example:



1. Starting with the type of fitting, #466 is a female connector. **C-0466-**
2. For a **1/4" OD** tubing by a **1/4"** female pipe thread, each is number **4** or **44** together, **C-0466-44**.

So, the number for a female connector for 1/4 tube and 1/4 pipe thread, is **C-0466-44**.

UNIT OF MEASURE	NUMBER
1/16	1
1/8	2
3/16	3
1/4	4
5/16	5
3/8	6
7/16	7
1/2	8
9/16	9
5/8	10
3/4	12
7/8	14
1	16

AIR BRAKE NYLON TUBE FITTINGS - (DOT APPROVED)

SLEEVE	PART#	TUBE OD	STD PKG
		C-0460-4	1/4"
	C-0460-6	3/8"	10
	C-0460-8	1/2"	10
	C-0460-10	5/8"	5
NUT	PART#	TUBE OD	STD PKG
		C-0461-4	1/4"
	C-0461-6	3/8"	5
	C-0461-8	1/2"	10
UNION	PART#	TUBE OD	STD PKG
		C-0462-4	1/4"
	C-0462-6	3/8"	10
	C-0462-8	1/2"	10
	C-0462-10	5/8"	5
TUBE SUPPORT	PART#	TUBE OD	STD PKG
		C-0463-4	1/4"
	C-0463-6	3/8"	10
	C-0463-8	1/2"	10
	C-0463-10	5/8"	10
BULKHEAD UNION	PART#	TUBE OD	STD PKG
		C-0475-4	1/4"
	C-0475-6	3/8"	5
	C-0475-8	1/2"	2

FEMALE CONNECTOR	PART#	TUBE OD	PIPE THREAD	STD PKG
		C-0466-44	1/4"	1/4"
	C-0466-66	3/8"	1/2"	5
	C-0466-128	3/4"	3/8"	2
MALE CONNECTOR	PART#	TUBE OD	PIPE THREAD	STD PKG
		C-0468-42	1/4"	1/8"
	C-0468-44	1/4"	1/4"	10
	C-0468-46	1/4"	3/8"	5
	C-0468-62	3/8"	1/8"	10
	C-0468-64	3/8"	1/4"	10
	C-0468-66	3/8"	3/8"	5
	C-0468-84	1/2"	1/4"	5
	C-0468-86	1/2"	3/8"	5
	C-0468-88	1/2"	1/2"	5
MALE ELBOW	PART#	TUBE OD	PIPE THREAD	STD PKG
		C-0469-42	1/4"	1/8"
	C-0469-44	1/4"	1/4"	5
	C-0469-46	1/4"	3/8"	5
	C-0469-64	3/8"	1/4"	10
	C-0469-66	3/8"	3/8"	5
	C-0469-86	1/2"	3/8"	2



Used with: Nylon tubing (SAE J844, type 3).

Advantages: Meets all air brake specifications. Utilizes ribbed sleeve for compression and positive grip. The body (less the insert) is interchangeable with standard air brake compression bodies. Special tools are not required.

Typical Applications: Air brake systems, air control and gauge lines. **Other sizes available upon request. See Kit C-KIT136 on page G6.**

PUSH TO CONNECT AIR BRAKE FITTINGS - (DOT APPROVED)

UNION	PART#	TUBE OD	STD PKG
		C-0962-4	1/4"
	C-0962-6	3/8"	5
	C-0962-8	1/2"	5
UNION TEE	PART#	TUBE OD	STD PKG
		C-0964-4	1/4"
UNION ELBOW	PART#	TUBE OD	STD PKG
		C-0965-4	1/4"

MALE CONNECTOR	PART#	TUBE OD	PIPE THREAD	STD PKG
		C-0968-42	1/4"	1/8"
	C-0968-44	1/4"	1/4"	5
	C-0968-46	1/4"	3/8"	5
	C-0968-62	3/8"	1/8"	5
	C-0968-64	3/8"	1/4"	5
	C-0968-66	3/8"	3/8"	5
	C-0968-68	3/8"	1/2"	5
	C-0968-88	1/2"	1/2"	5
MALE ELBOW	PART#	TUBE OD	PIPE THREAD	STD PKG
		C-0969-42	1/4"	1/8"
	C-0969-44	1/4"	1/4"	5
	C-0969-46	1/4"	3/8"	5
	C-0969-86	1/2"	3/8"	5
	C-0969-88	1/2"	1/2"	5







DESIGN FEATURES:







DOT marked and approved. Quick connect, simply push tubing in, no tools, or loose parts to handle in tight places. Full flow design provides up to 60% more flow area than conventional fittings with internal tube supports. Brass construction. Elbows and Tees are forged brass. **Other sizes available upon request. See Kit C-KIT38 on page G7.**

BRASS FITTINGS

K3

BRASS PIPE FITTINGS

REDUCING COUPLING	PART#	PIPE THREAD	STD PKG
	C-0010-42	1/4" X 1/8"	5
COUPLING			
	C-0103-2	1/8"	5
	C-0103-4	1/4"	5
	C-0103-6	3/8"	5
CAP			
	C-0108-2	1/8"	5
	C-0108-4	1/4"	5
	C-0108-6	3/8"	5
SQUARE HEAD PLUG			
	C-0109-2	1/8"	5
BUSHING			
	C-0110-42	1/4" X 1/8"	10
	C-0110-62	3/8" X 1/8"	10
	C-0110-64	3/8" X 1/4"	10
	C-0110-84	1/2" X 1/4"	5
	C-0110-86	1/2" X 3/8"	5
	C-0110-126	3/4" X 3/8"	5
CLOSE NIPPLE			
	C-0112-4	1/4"	10
	C-0112-6	3/8"	5

LONG NIPPLE	PART#	PIPE THREAD	STD PKG
	C-0113-220	1/8" X 2"	5
	C-0113-420	1/4" X 2"	5
STREET ELBOW			
	C-0116-2	1/8"	5
	C-0116-4	1/4"	5
	C-0116-6	3/8"	5
REDUCING ADAPTER			
	C-0120R-42	1/4" X 1/8"	10
	C-0120R-64	3/8" X 1/4"	10
	C-0120R-86	1/2" X 3/8"	5
PLUG - HEX HEAD			
	C-0121-2	1/8"	10
	C-0121-4	1/4"	10
	C-0121-6	3/8"	5
HEX NIPPLE			
	C-0122-2	1/8"	10
45° STREET ELBOW			
	C-0124-4	1/4"	10
MALE ELBOW			
	C-0126-6	3/8"	5



Used with: Brass, copper and iron pipe.

Advantages: Positive mechanical seal. Large range of styles and sizes available.

Typical Applications: Water, air, oil, natural gas and liquefied petroleum products.

Other sizes available upon request.

INVERTED FLARE

STANDARD INVERTED NUT	PART#	TUBE OD	STD PKG
	C-0105-3	3/16"	20
	C-0105-5	5/16"	20
UNION			
	C-0300-3	3/16"	10
	C-0300-5	5/16"	10





Used with: Copper, brass, aluminum and welded steel hydraulic tubing that can be flared.

Advantages: Low cost reusable assembly. Recessed and protected threads and seats designed to resist pullout. Short profile of nuts and bodies for use in tight spaces. Also allows close tube bends. Good vibration resistance. Will withstand burst pressure of standard tubing.

Typical Applications: Automotive brake, fuel and oil lines. LP and natural gas connections. Hazardous liquids, air, water, fuel, oil or gaseous chemicals not corrosive to tubing material or brass.

Other sizes available upon request.

STANDARD COMPRESSION FITTINGS

SLEEVE	PART#	TUBE OD	STD PKG	MALE ELBOW	PART#	TUBE OD	PIPE THREAD	STD PKG
	C-0060-2	1/8"	50		C-0069-42	1/4"	1/8"	5
	C-0060-4	1/4"	50					
	C-0060-6	3/8"	20					
UNION	C-0062-3	3/16"	10	FEMALE ELBOW	C-0070-22	1/8"	1/8"	5
	C-0062-4	1/4"	10					
	C-0062-5	5/16"	10					
	C-0062-6	3/8"	10					

Used with: Copper, brass, aluminum and plastic tubing. Not recommended for steel tubing. Soft plastic tubing requires internal tube support. (See page K2)

Advantages: Low cost. No flaring required. Easy to assemble. Available with long or short nut and in wide range of styles and sizes.

Typical Applications: Gasoline, oil, water, vacuum lines, air lines and other low and medium pressure uses where excessive vibration or tube movement is not involved. Use long nuts (161 Series) to improve vibration characteristics. **Other sizes available upon request.**

See Kit C-KIT290 on page G6.

45° SAE FLARE



SHORT NUT	PART#	TUBE OD	STD PKG
	C-0041S-6	3/8"	10

Used with: Copper, brass, aluminum and welded steel hydraulic tubing that can be flared.

Advantages: Low cost, reusable. Available with long or short nut and in wide range of styles and sizes. Will withstand burst pressure of standard tubing. Good vibration characteristics. Long nuts used where excessive vibration is present. Forged nuts available for refrigeration applications. Seal can be connected and disconnected frequently without damage.

Typical Applications: Fuel, oil, air, water, LP and natural gas lines, refrigeration (except where frost nuts are required), hazardous liquids or gaseous chemicals not corrosive to tubing material or brass.

Other sizes available upon request.

FEMALE CONNECTOR	PART#	TUBE OD	PIPE THREAD	STD PKG
	C-0046-64	3/8"	1/4"	5
MALE CONNECTOR	C-0048-66	3/8"	3/8"	5
				

AIR LINE HOSE BARBS

Industries used in: Automotive, air conditioning, food & beverage, hardware, industrial, L.P. Gas, pipe valve & fittings, plumbing and refrigeration. Other sizes available.

Other sizes available upon request.

MALE HOSE BARB	PART#	HOSE I.D.	PIPE THREAD	STD PKG
	C-0139-34	3/16"	1/4"	5
	C-0139-46	1/4"	3/8"	5
	C-0139-54	5/16"	1/4"	5
	C-0139-64	3/8"	1/4"	5

GROUND KEY SHUT-OFF COCKS

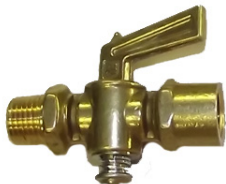

PART# C-0880-4

MALE TO FEMALE PIPES

1/8" Pipe thread. Shut-off cocks are manufactured for use with low-pressure air, water, gas and fluids. They are designed to withstand working pressures of 30 PSI.

Other sizes available. **Standard Package: 3**
Other sizes available upon request.

PUSH ON FITTINGS



PART# C-P112-44

MALE PIPE

1/4" Hose I.D. 1/4" Pipe thread. 25/32 Cut-off factor. **Standard Package: 5**
Other sizes available upon request.

BRASS FITTINGS SIZE CHARTS

K5

SAE NUT HEX SIZES (ACTUAL SIZE)

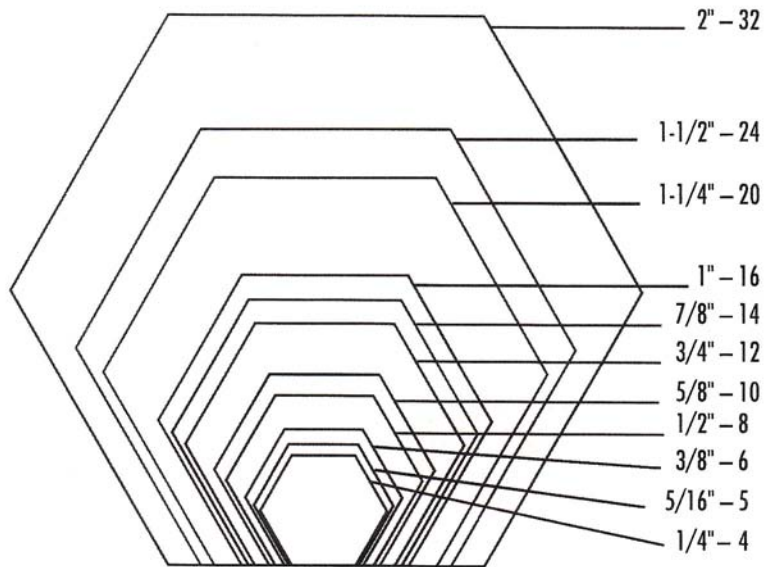

PIPE THREAD SIZES (ACTUAL SIZE)

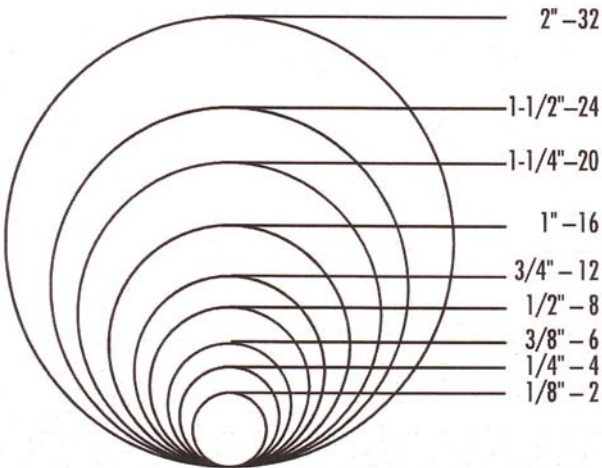

FLARE NOSE SIZES (ACTUAL SIZE)

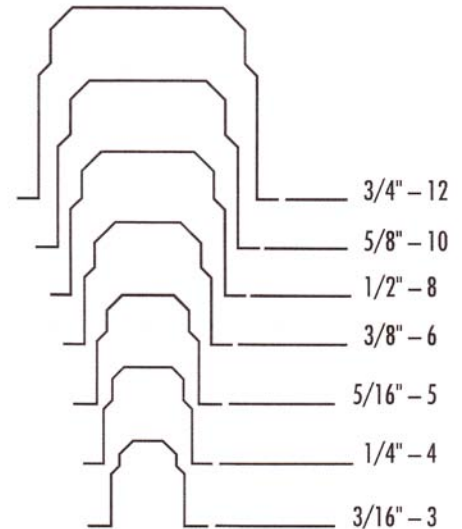

HYDRAULIC GREASE FITTING COUPLERS



PART# C-6100
HEAVY DUTY COUPLER
 1/8" female pipe thread with ball check. Will withstand 20,000 PSI. Made of nickel plated steel construction. For use with all types of hydraulic grease fittings.
Standard Package: 5



PART# C-6250
MIDGET COUPLER
 1/8" female pipe thread, wide angle seat with ball check. Made of nickel plated steel construction. For use with all types of hydraulic grease fittings.
Standard Package: 5

LUBRICATION HOSE

PART# C-6508
GREASE HOSE WHIP
 High pressure hose can be used with any type hand lever gun and coupler. 8" Long Single wire braid reinforced neoprene hose. 3/16" I.D., 1/8" male pipe thread on both ends. Other lengths available also in fiber braid reinforced nylon hose with 1/8" male pipe thread on both ends.
Standard Package: 5



AIR COUPLERS AND PLUGS

QUICK DISCONNECT COUPLERS AND PLUGS

Quick disconnect couplers are the fastest and most efficient way of joining pneumatic and fluid transfer lines. Although there are differences in outward appearance of couplers, nearly all quick disconnect couplers work on the same principle. Hardened balls or pins engage a groove in the coupler plug to hold it securely against a soft seal while permitting the assembly to swivel, thereby preventing kinking or twisting of hoses. A sliding sleeve releases the locking balls when retracted, permitting the plug to be inserted or removed. The sleeve automatically returns to the locked position when released. An automatic shutoff valve in the coupler seals instantly upon uncoupling, eliminating the need for a separate shut-off. **Other sizes available upon request.**



QUICK DISCONNECT COUPLERS AND PLUGS



ACME PART#	A-937B4F	A-937B4M	A-937N4F	A-937N4M
DESCRIPTION	Coupler Body	Coupler Body	Coupler Pin	Coupler Pin
	Female	Male	Female	Male
PIPE THREAD	1/4" FPT	1/4" MPT	1/4" FPT	1/4" MPT
FLOW I.D.	1/4"	1/4"	1/4"	1/4"
STD PKG	5	5	10	10

BALL SWIVEL



A-937N4BSF	A-937N4BS
Pin Swivel	Pin Swivel
Female	Male
1/4" FPT	1/4" MPT
1/4"	1/4"
5	5

ITEM INTERCHANGE

CORONET PART#	C-4461-4	C-4462-4	C-4472-4	C-4471-4
ARO PART#	23102-200	23102-212	23902-200	23902-210
MILTON PART#	715	716	728	727
TRU-FLATE PART#	13-234	13-224	12-234	12-224

INTRODUCTION TO AIR COUPLERS AND PLUGS

Acme Quick Disconnects offers a quick and efficient method of joining pneumatic lines. The operating principle for our sleeve couplers is basic, yet effective. By retracting the sliding sleeve of the coupler, internal locking balls are released, permitting the plug to be inserted or removed. The sleeve will automatically spring into the original (locked) position upon release. This forces the locking balls to engage the groove in the plug and hold it securely against a soft seal. The assembly is free to swivel which prevents any kinking or twisting of hoses, further reducing hose torque.

FEATURES AND BENEFITS

- **No need for separate shut-off:** The automatic shut-off valve in the coupler is open only when the plug is fully engaged. The valve seals instantly upon disengagement.
- **Positive locking ball and sleeve design:** Our positive locking ball and sleeve design assures maximum safety. The coupler sliding sleeve will not snap into place until the plug is fully engaged. The chances of accidental uncoupling are reduced because the sleeve must be pulled back to release the plug.
- **Sure grip sliding sleeve:** The knurled sleeves on our couplers are designed to permit a sure grip for easy operation, even with wet, oily, or gloved hands.
- **Prevents accidental uncoupling:** A solid ring on the end of our coupler protects the sliding sleeve from being snagged and uncoupled while hoses are dragged along the ground. Our 1/4" series feature six locking balls, permitting a more secure and balanced connection, and extending the life of the plug.
- **Full flow and maximum strength design:** Our tubular-milled, passage-valve design has a larger flow path than the hole in the mating plug. In addition, no portion of the valve enters the plug, so a clear flow path is assured. Full-circle contact between the valve and plug evenly distributes impact forces over a wide area for increased service life.

SELECTING A COUPLER / PLUG

- **Sizing a coupler / plug:** The body size and flow capacity of couplers generally correspond to the inside diameter of the hose with which they are used. For example, a hose with a diameter of 1/4" should be fitted with a 1/4" body size coupler. On hoses which run less than 50 feet, it is usually acceptable to use a coupler one size smaller than the hose size. A coupler more than one size smaller than the hose size will not pass enough air to allow the air tool to operate efficiently. High impact tools (wrenches, hammers, etc.) should use at least a 3/8" body coupler because the heavier valve is better suited to withstand the pounding forces caused by these tools.
- **Identifying a coupler / plug:** Lay your plug on the actual size chart shown to identify your plug style and flow (Inside ID). Couplers can be identified by their sleeves. Different type couplers have different groove patterns, making identification easy.

AIR COUPLERS AND PLUGS

INTERCHANGEABILITY

Many variations of the basic Quick Disconnect Coupler have been manufactured over the years. Acme couplers are designed to interchange with the three most popular plugs which have become standard in most automotive applications:

USE THESE ACTUAL SIZE PICTURES TO IDENTIFY YOUR PLUG TYPE

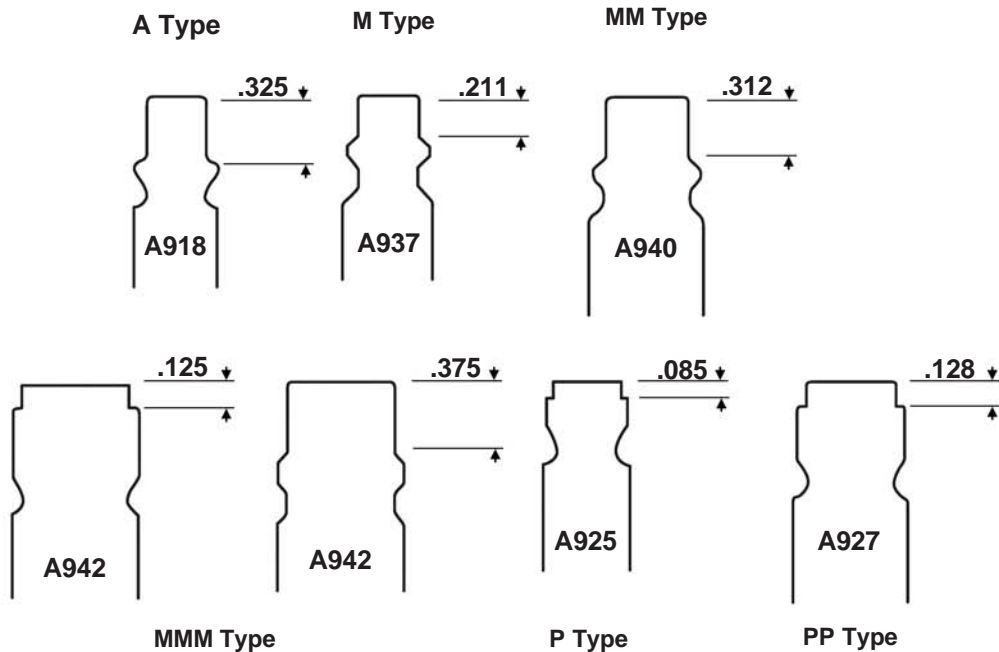

A Type	1/4" (internal diameter) ACME A918 series (Interchanges with ARO)
M Type	1/4" (internal diameter) ACME A937 series (Interchanges with Milton Industrial)
MM Type	3/8" (internal diameter) ACME A940 series (Interchanges with Milton Industrial)
MMM Type	1/2" (internal diameter) ACME A942 series (Interchanges with Milton Industrial)
P Type	1/4" (internal diameter) ACME A925 series (Interchanges with Parker / Tru-Flate)
PP Type	3/8" (internal diameter) ACME A927 series (Interchanges with Parker / Tru-Flate)
PPP Type	1/2" (internal diameter) ACME A942 series (Interchanges with Parker / Tru-Flate)

PART NUMBER INDEX

PART#	PAGE	PART#	PAGE	PART#	PAGE	PART#	PAGE	PART#	PAGE
1WPT-12	E11	3M-08180	J06	695C	H14	A2SF-10	A08	AC-122204	A19
2WPT10-15L	E11	3M-08609	J06	695R	H14	A2SF-6	A08	AC-122304	A19
2WPT14-15L	E11	3M-08661	J06	696B	H14	A2SL-6	A08	AC-123101	A19
30-15	E12	3M-08813	J06	696C	H14	A2SL-8	A08	AC-123103	A19
3M-00090	J05	3M-08875	J05	696R	H14	A3B	A02	AC-123104	A19
3M-01396	H04	3M-08881	J05	800A	H14	A3FE-187	A06	AC-123105	A19
3M-01397	H04	3M-08888	J06	800B	H14	A3FE-250	A06	AC-123107	A19
3M-01398	H04	3M-08897	J06	800R	H14	A3M-250	A06	AC-123108	A19
3M-01406	H04	3M-08898	J06	A-937B4F	K06	A3R-10HT	A11	AC-124103	A19
3M-01407	H04	3M-08911	J06	A-937B4M	K06	A3S-10HT	A11	AC-124204	A19
3M-01408	H04	3M-21210	J05	A-937N4BS	K06	A4B	A02	AC-125105	A19
3M-01914	H04	3M-26332	B17	A-937N4BSF	K06	A4B-WP	A02	AC-126402	A19
3M-01915	H04	3M-26334	B17	A-937NAF	K06	A4BF	A07	AC-126403	A19
3M-03451	B16	3M-26336	B17	A-937NAM	K06	A4BU	A07	AGC-1	B10
3M-05001	H05	3M-26340	B17	A1B	A02	A4FE-187	A06	AGC-10	B10
3M-05002	H05	3M-67533	B17	A1B-SLD-CR	A09	A4FE-250	A06	AGC-15	B10
3M-05004	H05	3M-67535	B17	A1B-SLD-NSP	A09	A4FEB-F	A07	AGC-2-1/2	B10
3M-05005	H05	3M-67636	B17	A1B-ST	A02	A4FEM-250	A07	AGC-20	B10
3M-05006	H05	3M-67885	B17	A1B-ST-E	A02	A4H-6	A10	AGC-25	B10
3M-05007	H05	3M-SIL	J05	A1BU-ST	A07	A4M-187	A06	AGC-3	B10
3M-05008	H05	3WF-110V	H14	A1FL-187	A11	A4M-250	A06	AGC-30	B10
3M-05009	H05	3WF-12	E11	A1FL-250	A11	A4PIN	A10	AGC-40	B10
3M-05010	H05	3WF-1610C	H14	A1P	A10	A4R-10	A04	AGC-5	B10
3M-05028	H05	3WM-110V	H14	A1R-10	A04	A4R-14	A04	AGC-7-1/2	B10
3M-05030	H05	3WM-12	E11	A1R-10ST	A04	A4R-38	A04	AGC-B1-1/2	B10
3M-05049	H05	3WM-1510P	H14	A1R-14	A04	A4R-56	A04	AGC-B10	B10
3M-05072	H05	400A	H14	A1R-14ST	A04	A4R-6	A04	AGC-B15	B10
3M-05539	H04	4WF-15L	E11	A1R-38	A04	A4R-8	A04	AGC-B20	B10
3M-05540	H04	4WF-36L	E11	A1R-38ST	A04	A4S-10	A08	AGC-B25	B10
3M-06147	B16	4WF-60L	E11	A1R-56	A04	A4S-6	A08	AGC-B3	B10
3M-06396	J06	4WFF-12	E11	A1R-6	A04	A4S-8	A08	AGC-B30	B10
3M-06480	B17	4WFF-48	E11	A1R-6ST	A04	A4SF-6	A08	AGC-B4	B10
3M-06483	B17	4WFF-60	E11	A1R-8	A04	A6FE-187-3M	A06	AGC-B40	B10
3M-07445	H05	4WFF-72	E11	A1R-8ST	A04	A6FE-250	A06	AGC-B5	B10
3M-07447	H05	4WFM-12	E11	A1S-10ST	A08	A6FE-250-3M	A06	AGC-B7-1/2	B10
3M-07448	H05	4WFM-20Y	E11	A1S-6ST	A08	A6FE-250ST	A06	AL-COW61510GP	H07
3M-07480	H04	4WFM-25Y	E11	A1S-8ST	A08	A6FE-250ST-3M	A06	AL-COW61515	H07
3M-07481	H04	4WFM-48	E11	A2B	A02	A6FEB	A07	AL-COW61515A	H07
3M-07485	H04	500A	H14	A2FE-187	A06	A6FEB-F	A07	AL-COW61517	H07
3M-07486	H04	50A	H14	A2FE-250	A06	A6FEB-ST	A07	AL-COW61541G	H07
3M-07515	H04	5WFF-72	E11	A2M-250	A06	A6FL-250	A11	AL-COW61541G-S	H07
3M-07524	H04	5WFM-48	E11	A2R-10	A04	A6M-187-3M	A06	AL-CSP113	H03
3M-07525	H04	692C	H14	A2R-14	A04	A6M-250	A06	AL-DPC64042	H06
3M-07526	H04	693B	H14	A2R-38	A04	A6M-250-3M	A06	AL-FDZ67411	H04
3M-08001	J05	693C	H14	A2R-56	A04	A6M-250ST-3M	A06	AL-FDZ67412	H04
3M-08008	J05	693R	H14	A2R-6	A04	A8B	A02	AL-FDZ67413	H04
3M-08011	J05	694B	H14	A2R-8	A04	AC-120101	A19	AL-FDZ67414	H04
3M-08074	J05	694C	H14	A2S-10	A08	AC-122101	A19	AL-FDZ67431	H04
3M-08088	J05	694R	H14	A2S-6	A08	AC-122104	A19	AL-FDZ67432	H04
3M-08090	J05	695B	H14	A2S-8	A08	AC-122108	A19	AL-FDZ67433	H04

PART NUMBER INDEX

PART#	PAGE	PART#	PAGE	PART#	PAGE	PART#	PAGE	PART#	PAGE
AL-FDZ67434	H04	ATC-B40	B08	B1R-10ST	A04	B3FE-250	A06	B6FE-187ST	A06
AL-FDZ67435	H04	ATC-B5	B08	B1R-12	A04	B3FE-250HT	A11	B6FE-250	A06
AL-FDZ67470	H06	ATC-B7-1/2	B08	B1R-14	A04	B3FEL-250	A13	B6FE-250-3M	A06
AL-FDZ67472	H06	ATC-TAP	B08	B1R-14SLD	A09	B3FEL-CO	A13	B6FE-250ST	A06
AL-FDZ67473	H06	ATM-10	B08	B1R-14ST	A04	B3FL-250HT	A11	B6FE-250ST-3M	A06
AL-FDZ67475	H06	ATM-15	B08	B1R-38	A04	B3M-187HT	A11	B6FEB	A07
AL-FDZ67497N	H06	ATM-2	B08	B1R-38ST	A04	B3M-250	A06	B6FEB-F	A07
AL-FDZ77475	H06	ATM-20	B08	B1R-56	A04	B3M-250HT	A11	B6FEB-ST	A07
AL-FDZ77476	H06	ATM-25	B08	B1R-56ST	A04	B3ML-250	A13	B6FL-250	A11
AL-FDZ77477N	H06	ATM-3	B08	B1R-6	A04	B3R-10HT	A11	B6M-187-3M	A06
AL-FW61751B	H06	ATM-30	B08	B1R-6ST	A04	B3R-14HT	A11	B6M-187ST	A06
AL-FW61752B	H06	ATM-5	B08	B1R-8	A04	B3R-6HT	A11	B6M-250	A06
AL-GW73141	H07	ATM-7-1/2	B08	B1R-8ST	A04	B3S-10HT	A11	B6M-250-3M	A06
AL-M61552	H07	ATM-B4	B08	B1S-10	A08	B4B	A02	B6M-250ST	A06
AL-QDH12	H04	ATM-LED10	B08	B1S-10ST	A08	B4B-WP	A02	B6M-250ST-3M	A06
AL-QDH13	H04	ATM-LED15	B08	B1S-14	A08	B4BF	A07	B8B	A02
AL-WB67105C	H06	ATM-LED20	B08	B1S-6ST	A08	B4BU	A07	BAP-1/2X3	D09
AL-WB67121	H05	ATM-LED25	B08	B1S-8	A08	B4FE-187	A06	BAP-5/8X3	D09
AL-WB67151	H06	ATM-LED30	B08	B1S-8ST	A08	B4FE-250	A06	BC-1	C05
AL-WB67153	H06	ATM-TAP	B08	B2B	A02	B4FE-250INS	A06	BC-1/0	C05
AL-WB67175	H05	ATMLP-B10	B08	B2BA	A03	B4FEB	A07	BC-1/0R	C05
AL-WB67193	H06	ATMLP-B15	B08	B2BA-ST	A03	B4FEB-F	A07	BC-1R	C05
AL-WB67195	H06	ATMLP-B20	B08	B2BAHL-ST	A03	B4FEM-250	A07	BC-2	C05
AMP-350550-1	A11	ATMLP-B25	B08	B2BF	A07	B4H-10	A10	BC-2/0	C05
AMP-350705-2	A11	ATMLP-B30	B08	B2BU	A07	B4H-8	A10	BC-2/0R	C05
ANN-200	B08	ATMLP-B7-1/2	B08	B2FE-187	A06	B4M-187	A06	BC-2R	C05
APT-1	B15	ATO-LED10	B08	B2FE-187-E	A06	B4M-250	A06	BC-4	C05
APT-2	B15	ATO-LED15	B08	B2FE-250	A06	B4M-250INS	A06	BC-4R	C05
APT-3	B15	ATO-LED20	B08	B2FEM-250	A07	B4PIN	A10	BC-6	C05
APT-H9004/7	B15	ATO-LED25	B08	B2M-187	A06	B4R-10	A04	BC-6R	C05
APT-H9005/H10	B15	ATO-LED3	B08	B2M-250	A06	B4R-12	A04	BLD-KNIFE	H03
APT-H9006	B15	ATO-LED30	B08	B2R-10	A04	B4R-14	A04	BLD-SINGLE	H03
ATC-1	B08	ATO-LED7-1/2	B08	B2R-12	A04	B4R-38	A04	BLD-UTILITY	H03
ATC-10	B08	AVC-11154	B15	B2R-14	A04	B4R-56	A04	BNB-1/4	A18
ATC-15	B08	AVC-16004	A12	B2R-38	A04	B4R-6	A04	BNB-WS	A18
ATC-20	B08	AVC-16004	H02	B2R-56	A04	B4R-8	A04	BPC	A18
ATC-25	B08	AVC-20690	H03	B2R-6	A04	B4RS-10	A11	BR-39213	D17
ATC-3	B08	AVC-20691	H03	B2R-8	A04	B4S-10	A08	BR-39300	D17
ATC-30	B08	B1B	A02	B2S-10	A08	B4S-6	A08	BR-HP2	D17
ATC-40	B08	B1B-SLD	A09	B2S-6	A08	B4S-8	A08	BR-KIT626	G15
ATC-5	B08	B1B-SLD-CR	A09	B2S-8	A08	B4SF-10	A08	BR3-2AAD	D16
ATC-7-1/2	B08	B1B-ST	A02	B2SF-10	A08	B4SF-6	A08	BR3-2SSD	D16
ATC-B1	B08	B1B-ST-E	A02	B2SF-6	A08	B4SF-8	A08	BR3-4AAD	D16
ATC-B10	B08	B1BF-ST	A07	B2SF-8	A08	B4SL-10	A08	BR3-4SSD	D16
ATC-B15	B08	B1BU-ST	A07	B2SL-6	A08	B4SL-6	A08	BR4-10AAD	D16
ATC-B2	B08	B1FL-187	A11	B2SL-8	A08	B4SL-8	A08	BR4-2AAD	D16
ATC-B20	B08	B1FL-250	A11	B2Y	A10	B4X	A10	BR4-2AADL	D17
ATC-B25	B08	B1P	A10	B3B	A02	B4Y	A10	BR4-2ASD	D16
ATC-B3	B08	B1R-10	A04	B3FE-187	A06	B6FE-187	A06	BR4-3AAD	D16
ATC-B30	B08	B1R-10SLD	A09	B3FE-187HT	A11	B6FE-187-3M	A06	BR4-4AAD	D16

PART NUMBER INDEX

PART#	PAGE	PART#	PAGE	PART#	PAGE	PART#	PAGE	PART#	PAGE
BR4-4AADL	D17	BRBUW-4A	D17	BTCR-4P	A19	C-0041S-6	K04	C-0460-6	K02
BR4-4ASD	D16	BRBUW-6A	D17	BTCR-4U	A19	C-0046-64	K04	C-0460-8	K02
BR4-4SSD	D16	BTC-1012	A19	BTCR-SLUG	G13	C-0048-66	K04	C-0461-4	K02
BR4-4SSDL	D17	BTC-1038	A19	BTCR-SLUG1	A09	C-0060-2	K04	C-0461-6	K02
BR4-4STD	D16	BTC-1056	A19	BTCR-SLUG1/0	A09	C-0060-4	K04	C-0461-8	K02
BR4-6AAD	D16	BTC-138	A19	BTCR-SLUG2	A09	C-0060-6	K04	C-0462-10	K02
BR4-6ASD	D16	BTC-156	A19	BTCR-SLUG2/0	A09	C-0062-3	K04	C-0462-4	K02
BR4-6SSD	D16	BTC-2012	A19	BTCR-SLUG3/0	A09	C-0062-4	K04	C-0462-6	K02
BR4-6STD	D16	BTC-2038	A19	BTCR-SLUG4	A09	C-0062-5	K04	C-0462-8	K02
BR4-8AAD	D16	BTC-2056	A19	BTCR-SLUG4/0	A09	C-0062-6	K04	C-0463-10	K02
BR4-8ASD	D16	BTC-212	A19	BTCR-SLUG6	A09	C-0069-42	K04	C-0463-4	K02
BR5-10AAD	D16	BTC-214	A19	BTCR90-1/0N	A19	C-0070-22	K04	C-0463-6	K02
BR5-4AAD	D16	BTC-238	A19	BTCR90-1/0P	A19	C-0103-2	K03	C-0463-8	K02
BR5-6AAD	D16	BTC-256	A19	BTCR90-2/0N	A19	C-0103-4	K03	C-0466-128	K02
BR5-8AAD	D16	BTC-3012	A19	BTCR90-2/0P	A19	C-0103-6	K03	C-0466-44	K02
BR6-10AAD	D16	BTC-3038	A19	BTCRFB-NUT	A19	C-0105-3	K03	C-0466-66	K02
BR6-10AADL	D17	BTC-4012	A19	BTE	A18	C-0105-5	K03	C-0468-42	K02
BR6-10SSD	D16	BTC-4038	A19	BTE-B	A18	C-0108-2	K03	C-0468-44	K02
BR6-10STD	D16	BTC-414	A19	BTE-CB	C05	C-0108-4	K03	C-0468-46	K02
BR6-12AAD	D16	BTC-438	A19	BTE-CR	C05	C-0108-6	K03	C-0468-62	K02
BR6-12AADL	D17	BTC-456	A19	BTE-HD	A18	C-0109-2	K03	C-0468-64	K02
BR6-12SSDL	D17	BTC-614	A19	BTE-HD-B	A18	C-0110-126	K03	C-0468-66	K02
BR6-16AAD	D16	BTC-638	A19	BTE-S	A18	C-0110-42	K03	C-0468-84	K02
BR6-2AAD	D16	BTC-656	A19	BTMI-N	A18	C-0110-62	K03	C-0468-86	K02
BR6-2SSD	D16	BTC-838	A19	BTMI-P	A18	C-0110-64	K03	C-0468-88	K02
BR6-4AAD	D16	BTC-KIT135	G05	BX-ML12	G16	C-0110-84	K03	C-0469-42	K02
BR6-4AADL	D17	BTC-P1&212	A19	BX-ML21	G16	C-0110-86	K03	C-0469-44	K02
BR6-4ASD	D16	BTC-P1&238	A19	BX-ML24	G16	C-0112-4	K03	C-0469-46	K02
BR6-4ASDL	D17	BTC-P1&256	A19	BX-ML32	G16	C-0112-6	K03	C-0469-64	K02
BR6-4SSD	D16	BTC-P1012	A19	BX-MLADJ-H	G16	C-0113-220	K03	C-0469-66	K02
BR6-4SSDL	D17	BTC-P1038	A19	BX-MLADJ-V	G16	C-0113-420	K03	C-0469-86	K02
BR6-4STD	D16	BTC-P2012	A19	BX-PL06	G16	C-0116-2	K03	C-0475-4	K02
BR6-6AAD	D16	BTC-P2038	A19	BX-PL12	G16	C-0116-4	K03	C-0475-6	K02
BR6-6AADL	D17	BTC-P3012	A19	BX-PL16	G16	C-0116-6	K03	C-0475-8	K02
BR6-6ASD	D16	BTC-P3038	A19	BX-PL24	G16	C-0120R-42	K03	C-0610	D18
BR6-6ASDL	D17	BTC-P4012	A19	BX-PS06	G16	C-0120R-64	K03	C-0613	D18
BR6-6SSDL	D17	BTC-P4038	A19	BX-PS12	G16	C-0120R-86	K03	C-0637	D18
BR6-6STD	D16	BTC-P438	A19	BX-PS13	G16	C-0121-2	K03	C-0638	D18
BR6-8AAD	D16	BTC-P456	A19	BX-PS18	G16	C-0121-4	K03	C-0641	D18
BR6-8AADL	D17	BTCR-1&2N	A19	BX-PS18	G16	C-0121-6	K03	C-0667	D18
BR6-8ASD	D16	BTCR-1&2P	A19	BXI-ML12	G16	C-0122-2	K03	C-0688	D18
BR6-8ASDL	D17	BTCR-1/0N	A19	BXI-ML21	G16	C-0124-4	K03	C-0698	D18
BR6-8SSDL	D17	BTCR-1/0P	A19	BXI-ML24	G16	C-0139-34	K04	C-0880-4	K04
BR8-10AAD	D16	BTCR-2/0N	A19	BXI-ML32	G16	C-0139-46	K04	C-0962-4	K02
BR8-10ASD	D16	BTCR-2/0P	A19	BXI-MLADJ-H	G16	C-0139-54	K04	C-0962-6	K02
BR8-12AAD	D16	BTCR-3/0N	A19	BXI-MLADJ-V	G16	C-0139-64	K04	C-0962-8	K02
BR8-4AAD	D16	BTCR-3/0P	A19	BXR-M920	G15	C-0300-3	K03	C-0964-4	K02
BR8-4ASD	D16	BTCR-4/0N	A19	BXR-M920KIT	G12	C-0300-5	K03	C-0965-4	K02
BR8-6AAD	D16	BTCR-4/0P	A19	BXR-PS5	G16	C-0460-10	K02	C-0968-42	K02
BR8-8AAD	D16	BTCR-4N	A19	C-0010-42	K03	C-0460-4	K02	C-0968-44	K02

PART NUMBER INDEX

PART#	PAGE	PART#	PAGE	PART#	PAGE	PART#	PAGE	PART#	PAGE
C-0968-46	K02	C2R-14	A04	CB-221-15	B12	CP-116X1	D10	CSC-12134	D02
C-0968-62	K02	C2R-38	A04	CB-221-20	B12	CP-116X112	D10	CSC-122	D02
C-0968-64	K02	C2R-56	A04	CB-221-25	B12	CP-116X114	D10	CSC-12212	D02
C-0968-66	K02	C2R-6	A04	CB-221-30	B12	CP-116X12	D10	CSC-12214	D02
C-0968-68	K02	C2R-8	A04	CB-223-20	B12	CP-116X2	D10	CSC-123	D02
C-0968-88	K02	C2S-10	A08	CB-223-30	B12	CP-116X34	D10	CSC-12312	D02
C-0969-42	K02	C2S-14	A08	CB-ATC10	B12	CP-18X1	D10	CSC-1234	D02
C-0969-44	K02	C2S-8	A08	CB-ATC15	B12	CP-18X112	D10	CSC-124	D02
C-0969-46	K02	C2SF-10	A08	CB-ATC20	B12	CP-18X114	D10	CSC-12412	D02
C-0969-86	K02	C2SF-6	A08	CB-ATC30	B12	CP-18X134	D10	CSC-125	D02
C-0969-88	K02	C2SF-8	A08	CB-ATM10	B12	CP-18X2	D10	CSC-141	D02
C-3610	D18	C2Y	A10	CB-ATM20	B12	CP-18X212	D10	CSC-14112	D02
C-6100	K06	C3B	A02	CB-ATM30	B12	CP-18X3	D10	CSC-14114	D02
C-6250	K06	C3FE-250	A06	CB-MAX30	B12	CP-316X1	D10	CSC-1412	D02
C-6508	K06	C3FE-375	A06	CB-MAX50	B12	CP-316X112	D10	CSC-14134	D02
C-KIT136	G06	C3R-10HT	A11	CH-01255	E13	CP-316X134	D10	CSC-142	D02
C-KIT290	G06	C3R-6HT	A11	CH-03029	B13	CP-316X2	D10	CSC-14212	D02
C-KIT38	G07	C4B	A02	CH-05007	E05	CP-316X212	D10	CSC-14214	D02
C-P112-44	K04	C4B-WP	A02	CH-05543-15	E03	CP-316X312	D10	CSC-143	D02
C0126-6	K03	C4FE-250	A06	CH-05582	E03	CP-332X1	D10	CSC-14312	D02
C1B	A02	C4FE-375	A06	CH-05582-10	E03	CP-332X112	D10	CSC-1434	D02
C1B-SLD	A09	C4M-250	A06	CH-09095	E06	CP-332X114	D10	CSC-144	D02
C1B-SLD-CR	A09	C4PIN	A10	CH-11041-06	E15	CP-332X134	D10	CSC-14412	D02
C1B-ST	A02	C4R-10	A04	CH-11042-05	E15	CP-332X2	D10	CSC-145	D02
C1B-ST-E	A02	C4R-12	A04	CH-11250-01	E15	CP-532X1	D10	CSC-381	D02
C1P	A10	C4R-14	A04	CH-24008	E09	CP-532X112	D10	CSC-38112	D02
C1R-10	A04	C4R-38	A04	CH-24059	E09	CP-532X134	D10	CSC-38114	D02
C1R-10ST	A04	C4R-56	A04	CH-24063	E09	CP-532X2	D10	CSC-38134	D02
C1R-12ST	A04	C4R-6	A04	CH-24106	E09	CP-KIT950L	G12	CSC-382	D02
C1R-14	A04	C4R-8	A04	CH-24117	E09	CPS1161	D14	CSC-38212	D02
C1R-14ST	A04	C4S-10	A08	CH-24143	E09	CPS11634	D14	CSC-38214	D02
C1R-38	A04	C4SF-10	A08	CH-50046	E05	CPS181	D14	CSC-383	D02
C1R-38ST	A04	C4SL-10	A08	CH-55012	E03	CPS18112	D14	CSC-38312	D02
C1R-56	A04	C6FE-250-3M	A06	CH-55021-04	E03	CPS1825	D14	CSC-3834	D02
C1R-56ST	A04	C6FE-250-E	A06	CH-55036	E03	CPS3321	D14	CSC-384	D02
C1R-6	A04	C6FE-250ST	A06	CH-55057	E03	CPS332112	D14	CSC-38412	D02
C1R-6ST	A04	C6FL-250	A11	CH-56300-01	E05	CPS332114	D14	CSC-385	D02
C1R-8	A04	C6M-250-3M	A06	CH-57013-8	E05	CR-1	H02	CSC-5161	D02
C1R-8ST	A04	C6M-250ST	A06	CH-58328-04	E05	CR-12-9002	H02	CSC-516112	D02
C1S-10ST	A08	C8B	A02	CH-58328-11	E05	CR-4	H02	CSC-516114	D02
C1S-6ST	A08	CB-174-10	B12	CH-75908	E06	CR-6	H02	CSC-51612	D02
C2B	A02	CB-174-15	B12	CH-81264	E03	CR-BTC	H02	CSC-516134	D02
C2BB	A03	CB-174-20	B12	CH-82065	E06	CR-HD	H02	CSC-5162	D02
C2BB-ST	A03	CB-174-30	B12	CH-83280-03	E06	CR-HD-S	H02	CSC-516212	D02
C2BBHL-ST	A03	CB-185-100	B12	CH-83357	E09	CR-PA1441	A14	CSC-516214	D02
C2FE-250	A06	CB-185-135	B12	CH-95512A	E08	CR-TR50	H02	CSC-5163	D02
C2FE-375	A06	CB-185-150	B12	CH-956-6307	E08	CSC-121	D02	CSC-516312	D02
C2M-250	A06	CB-185-50	B12	CH-96101	E07	CSC-12112	D02	CSC-51634	D02
C2R-10	A04	CB-185-80	B12	CH-M606	E05	CSC-12114	D02	CSC-5164	D02
C2R-12	A04	CB-221-10	B12	CH-M608	E06	CSC-1212	D02	CSC-516412	D02

PART NUMBER INDEX

PART#	PAGE	PART#	PAGE	PART#	PAGE	PART#	PAGE	PART#	PAGE
CSC-5165	D02	CSC8-125	D03	CSC8-516112	D03	CSC8-9162	D03	CSM-6X16	D07
CSC-581	D02	CSC8-126	D03	CSC8-516114	D03	CSC8-916212	D03	CSM-6X20	D07
CSC-58112	D02	CSC8-141	D03	CSC8-51612	D03	CSC8-9163	D03	CSM-6X25	D07
CSC-58114	D02	CSC8-14112	D03	CSC8-516134	D03	CSC8-916312	D03	CSM-6X30	D07
CSC-58134	D02	CSC8-14114	D03	CSC8-5162	D03	CSC8-9164	D03	CSM-6X35	D07
CSC-582	D02	CSC8-1412	D03	CSC8-516212	D03	CSC8-916412	D03	CSM-6X45	D07
CSC-58212	D02	CSC8-14134	D03	CSC8-516214	D03	CSC8-9165	D03	CSM-8X10	D07
CSC-58214	D02	CSC8-142	D03	CSC8-516234	D03	CSC8-9166	D03	CSM-8X12	D07
CSC-583	D02	CSC8-14212	D03	CSC8-5163	D03	CSCS141	D14	CSM-8X16	D07
CSC-58312	D02	CSC8-14214	D03	CSC8-516312	D03	CSCS14112	D14	CSM-8X20	D07
CSC-584	D02	CSC8-14234	D03	CSC8-516314	D03	CSCS14114	D14	CSM-8X25	D07
CSC-58412	D02	CSC8-143	D03	CSC8-51634	D03	CSCS1412	D14	CSM-8X30	D07
CSC-585	D02	CSC8-14312	D03	CSC8-5164	D03	CSCS14134	D14	CSM-8X35	D07
CSC-7161	D02	CSC8-1434	D03	CSC8-516412	D03	CSCS142	D14	CSM-8X40	D07
CSC-716112	D02	CSC8-144	D03	CSC8-5165	D03	CSCS14212	D14	CSM-8X45	D07
CSC-716114	D02	CSC8-14412	D03	CSC8-51658	D03	CSCS1434	D14	CSM-8X50	D07
CSC-716134	D02	CSC8-145	D03	CSC8-5166	D03	CSCS1434	D14	CT	H03
CSC-7162	D02	CSC8-1458	D03	CSC8-581	D03	CSCS381	D14	CT-10	H03
CSC-716212	D02	CSC8-146	D03	CSC8-58112	D03	CSCS38112	D14	CW-3X1/16X3/8	H07
CSC-716214	D02	CSC8-341	D03	CSC8-58114	D03	CSCS38114	D14	CW-3X1/32X3/8	H07
CSC-7163	D02	CSC8-34112	D03	CSC8-58134	D03	CSCS382	D14	CW-3X3/32X3/8	H07
CSC-716312	D02	CSC8-34134	D03	CSC8-582	D03	CSCS38212	D14	CW-4X1/32X3/8	H07
CSC-71634	D02	CSC8-342	D03	CSC8-58212	D03	CSCS5161	D14	CW-4X3/32X3/8	H07
CSC-7164	D02	CSC8-34212	D03	CSC8-58214	D03	CSCS516112	D14	CW-PSB-12X1/8X1	H07
CSC-716412	D02	CSC8-34214	D03	CSC8-58234	D03	CSCS516114	D14	CWM-3/8	H07
CSC-7165	D02	CSC8-343	D03	CSC8-583	D03	CSCS5162	D14	D1B	A02
CSC-9161	D02	CSC8-34312	D03	CSC8-58312	D03	CSCS516212	D14	D1B-ST	A02
CSC-916112	D02	CSC8-344	D03	CSC8-584	D03	CSCS5163	D14	D1R-10	A04
CSC-9162	D02	CSC8-34412	D03	CSC8-58412	D03	CSM-10X20	D07	D1R-10ST	A04
CSC-916212	D02	CSC8-345	D03	CSC8-585	D03	CSM-10X25	D07	D1R-12	A04
CSC-9163	D02	CSC8-346	D03	CSC8-586	D03	CSM-10X30	D07	D1R-14	A04
CSC-916312	D02	CSC8-381	D03	CSC8-7161	D03	CSM-10X35	D07	D1R-14ST	A04
CSC-9164	D02	CSC8-38112	D03	CSC8-716112	D03	CSM-10X40	D07	D1R-38	A04
CSC-916412	D02	CSC8-38114	D03	CSC8-716114	D03	CSM-10X45	D07	D1R-38ST	A04
CSC-9165	D02	CSC8-3812	D03	CSC8-716134	D03	CSM-10X50	D07	D1R-56	A04
CSC51634	D14	CSC8-38134	D03	CSC8-7162	D03	CSM-10X55	D07	D1R-56ST	A04
CSC8-121	D03	CSC8-382	D03	CSC8-716212	D03	CSM-10X60	D07	D2B	A02
CSC8-12112	D03	CSC8-38212	D03	CSC8-716214	D03	CSM-12X25	D07	D2BC	A03
CSC8-12114	D03	CSC8-38214	D03	CSC8-716234	D03	CSM-12X30	D07	D2BC-ST	A03
CSC8-12134	D03	CSC8-38234	D03	CSC8-7163	D03	CSM-12X35	D07	D2R-10	A04
CSC8-122	D03	CSC8-383	D03	CSC8-716312	D03	CSM-12X40	D07	D4B	A02
CSC8-12212	D03	CSC8-38312	D03	CSC8-71634	D03	CSM-12X50	D07	D4R-10	A04
CSC8-12214	D03	CSC8-38314	D03	CSC8-7164	D03	CSM-12X55	D07	D4R-12	A04
CSC8-12234	D03	CSC8-3834	D03	CSC8-716412	D03	CSM-12X60	D07	D4R-14	A04
CSC8-123	D03	CSC8-384	D03	CSC8-7165	D03	CSM-5X10	D07	D4R-38	A04
CSC8-12312	D03	CSC8-38412	D03	CSC8-7166	D03	CSM-5X20	D07	D4R-56	A04
CSC8-12314	D03	CSC8-385	D03	CSC8-9161	D03	CSM-5X25	D07	DB-1/16	H10
CSC8-1234	D03	CSC8-3858	D03	CSC8-916112	D03	CSM-5X30	D07	DB-1/2	H10
CSC8-124	D03	CSC8-386	D03	CSC8-916114	D03	CSM-6X10	D07	DB-1/4	H10
CSC8-12412	D03	CSC8-5161	D03	CSC8-916134	D03	CSM-6X12	D07	DB-1/8	H10

PART NUMBER INDEX

PART#	PAGE	PART#	PAGE	PART#	PAGE	PART#	PAGE	PART#	PAGE
DB-11/32	H10	DBDFML-29/64	H10	DE-W4P	A14	DYN-52105	J03	EP-SS18	C05
DB-15/64	H10	DBDFML-3/16	H10	DE-W4S	A14	DYN-52115	J03	EP-SS32	C05
DB-17/32	H10	DBDFML-3/8	H10	DE-W6P	A14	DYN-52145	J03	EP-SS49	C05
DB-17/64	H10	DBDFML-31/64	H10	DE-W6S	A14	DYN-52146	J03	EP-ST50	C05
DB-23/64	H10	DBDFML-5/16	H10	DR-18	G16	DYN-52165	J03	EP-ST65	C05
DB-3/16	H10	DBDFML-7/16	H10	DR-18DIVIDER	G16	DYN-52175	J03	EP-STCP2J	A18
DB-3/32	H10	DBDFML-7/32	H10	DTC-180	B16	DYN-53104	J04	ER-5704	E11
DB-3/8	H10	DBDFML-9/32	H10	DTC-180BLK	B16	E1B	A02	EXTDL-16/3-25MC	H14
DB-5/16	H10	DBDFMLTS-1/2	H11	DTC-AF973	B16	E1R-10	A05	F1B	A03
DB-5/32	H10	DBDFMLTS-13/32	H11	DWS-1	D13	E1R-12	A05	F1R-10	A05
DB-5/64	H10	DBDFMLTS-15/32	H11	DWS-114	D13	E1R-14	A05	F1R-12	A05
DB-7/32	H10	DBDFMLTS-25/64	H11	DWS-158	D13	E1R-38	A05	F1R-14	A05
DB-7/64	H10	DBDFMLTS-27/64	H11	DWS-2	D13	E1R-56	A05	F1R-38	A05
DB-9/64	H10	DBDFMLTS-29/64	H11	DWS-212	D13	E2B	A02	F1R-56	A05
DBDED-1/4	H10	DBDFMLTS-31/64	H11	DWS-3	D13	E2R-56	A05	F2R-38	A05
DBDED-1/8	H10	DBDFMLTS-7/16	H11	DWS-F1	D13	E4B	A02	F2R-56	A05
DBDED-3/16	H10	DBDS-29DFML	H10	DWS-F2	D13	E4R-10	A05	F4R-14	A05
DBDF-1/16	H10	DBDS-29DFMLTS	H11	DWS-F212	D13	E4R-12	A05	F4R-38	A05
DBDF-1/2	H10	DBJDC-1/2	H10	DWS-F3	D13	E4R-14	A05	FA-KIT505	G05
DBDF-1/4	H10	DBJDC-1/4	H10	DYN-49200	J02	E4R-38	A05	FB-1	B11
DBDF-1/8	H10	DBJDC-1/8	H10	DYN-49202	J02	E4R-56	A05	FB-ATC10	B11
DBDF-11/32	H10	DBJDC-3/16	H10	DYN-49203	J02	EP-31CP	A18	FB-ATC12	B11
DBDF-11/64	H10	DBJDC-3/8	H10	DYN-49204	J02	EP-4320	C05	FB-ATC4	B11
DBDF-13/64	H10	DBJDC-5/16	H10	DYN-49271	J02	EP-643	J09	FB-ATC4L	B11
DBDF-15/64	H10	DC-7	H14	DYN-49272	J02	EP-647	J09	FB-ATC6	B11
DBDF-17/64	H10	DE-0411-240-2005	A14	DYN-49274	J02	EP-648	J09	FB-ATC6L	B11
DBDF-19/64	H10	DE-0411-310-1605	A14	DYN-49280	J02	EP-828	A18	FB-ATC8	B11
DBDF-21/64	H10	DE-0460-202-16141	A14	DYN-49285	J02	EP-828L	A18	FCL	C10
DBDF-23/64	H10	DE-0460-215-16141	A14	DYN-49286	J02	EP-999B	A18	FCM	C10
DBDF-25/64	H10	DE-0462-201-16141	A14	DYN-49401	J04	EP-B12	C05	FCS	C10
DBDF-3/16	H10	DE-0462-209-16141	A14	DYN-49403	J04	EP-B38BLK	C05	FCS-S	C10
DBDF-3/32	H10	DE-114010	A14	DYN-49412	J04	EP-B48	C05	FH-12	B10
DBDF-3/8	H10	DE-DT04-12PA	A14	DYN-49433	J04	EP-B65	C05	FH-14	B10
DBDF-5/16	H10	DE-DT04-2P	A14	DYN-49442	J02	EP-E12	C05	FH-3M	B09
DBDF-5/32	H10	DE-DT04-3P	A14	DYN-49446	J02	EP-GSC12	C05	FH-ATC	B09
DBDF-5/64	H10	DE-DT04-4P	A14	DYN-49452	J02	EP-GSC20	C05	FH-ATC30	B09
DBDF-7/32	H10	DE-DT04-6P	A14	DYN-49456	J02	EP-GSC9	C05	FH-ATC35	B09
DBDF-7/64	H10	DE-DT06-12SA	A14	DYN-49494	J03	EP-L13	C05	FH-ATM	B09
DBDF-9/64	H10	DE-DT06-2S	A14	DYN-49550	J04	EP-L16	C05	FH-ATM30	B09
DBDFML-1/2	H10	DE-DT06-3S	A14	DYN-49558	J04	EP-S10	C05	FH-HHA-I	B09
DBDFML-1/4	H10	DE-DT06-4S	A14	DYN-49560	J04	EP-S15	C05	FH-HHH-I	B09
DBDFML-11/32	H10	DE-DT06-6S	A14	DYN-49576	J04	EP-S20	C05	FH-MAX	B09
DBDFML-13/64	H10	DE-HDT-48-00	A14	DYN-49582	J04	EP-S23	C05	FH-MAX-B	B09
DBDFML-15/32	H10	DE-KIT142	G03	DYN-49596	J03	EP-S23BLK	C05	FH-MAX-C	B09
DBDFML-15/64	H10	DE-W12P	A14	DYN-49611	J03	EP-S27BLK	C05	FH-PANEL	B10
DBDFML-17/64	H10	DE-W12S	A14	DYN-49634	J04	EP-S34BLK	C05	FH-U	B10
DBDFML-19/64	H10	DE-W2P	A14	DYN-49635	J04	EP-S43	C05	FH-WP12ATC	B09
DBDFML-21/64	H10	DE-W2S	A14	DYN-49665	J03	EP-S48	C05	FH-WP16ATM	B09
DBDFML-23/64	H10	DE-W3P	A14	DYN-49670	J03	EP-SM-SPACER	A18	FL-550	B13
DBDFML-27/64	H10	DE-W3S	A14	DYN-49673	J03	EP-SS16	C05	FL-552	B13

PART NUMBER INDEX

PART#	PAGE	PART#	PAGE	PART#	PAGE	PART#	PAGE	PART#	PAGE
FL-575	B13	FNW-316X114	D04	FW8-USS-5/16	D04	GM-12004572	B11	GM-12124582	A12
FL-LED-EF30AL	B13	FNW-38X112	D04	FW8-USS-5/8	D04	GM-12004572	A13	GM-12124587	A12
FL-LED-EF32L	B13	FNW-516X112	D04	FW8-USS-7/16	D04	GM-12004943	B11	GM-12129409	A13
FL-TRI-12	B13	FNW-516X114	D04	FW8-USS-7/8	D04	GM-12004996	A13	GM-12191503	E12
FL-TRI-12I	B13	FNWHD-12X2	D04	FW8-USS-9/16	D04	GM-12004996	B11	GM-15324983	A12
FL-TRI-13	B13	FNWHD-14X1	D04	FW8HD-SAE-1	D04	GM-12010293	A12	GM-KIT190	G02
FL-TRI-13A2	B13	FNWHD-14X112	D04	FW8HD-SAE-1/2	D04	GM-12010300	A12	GM-KIT300	G02
FL-TRI-23	B13	FNWHD-38X114	D04	FW8HD-SAE-1/4	D04	GM-12010717	A12	GR-01-6969-82	F11
FLEX112BLK	C07	FNWHD-38X134	D04	FW8HD-SAE-3/4	D04	GM-12010973	A12	GR-52362-3	F14
FLEX114BLK	C07	FNWHD-516X114	D04	FW8HD-SAE-3/8	D04	GM-12010974	A12	GR-52372-3	F14
FLEX12BLK	C07	FNWHD-516X134	D04	FW8HD-SAE-5/16	D04	GM-12010975	A12	GR-653002-2	F14
FLEX14BLK	C07	FNWS101	D14	FW8HD-SAE-5/8	D04	GM-12010996	A12	GR-92382-3	F14
FLEX18BLK	C07	FNWS141	D14	FW8HD-SAE-7/16	D04	GM-12015024	A12	GR-92392-3	F14
FLEX2BLK	C07	FNWS14114	D14	FW8HD-SAE-7/8	D04	GM-12015193	A12	GR-99170	J08
FLEX34BLK	C07	FNWS38112	D14	FW8HD-SAE-9/16	D04	GM-12015306	A13	GR-99180	J08
FLEX38BLK	C07	FNWS516112	D14	FWM-10	D07	GM-12015323	A12	GS-2128	B15
FLF-20	B11	FUL-14	B11	FWM-12	D07	GM-12015791	A12	GS-2128A	B15
FLF-30	B11	FUL-S14	B11	FWM-4	D07	GM-12015792	A12	GS-2144A	B15
FLF-40	B11	FW-SAE-1	D04	FWM-5	D07	GM-12015793	A12	GS-3480	B15
FLF-50	B11	FW-SAE-1/2	D04	FWM-6	D07	GM-12015797	A12	GW-4-1/2X1/4X7/8	H07
FLF-60	B11	FW-SAE-1/4	D04	FWM-8	D07	GM-12015798	A12	GW-4.5X1/4X5/8-11	H07
FLH-1/4	C08	FW-SAE-10	D04	FWS1/2	D14	GM-12015799	A12	GW-4X1/4X5/8	H07
FLH-3/16	C08	FW-SAE-12	D04	FWS1/4	D14	GM-12015870	A13	GW-7X1/4X5/8-11	H07
FLH-3/8	C08	FW-SAE-3/4	D04	FWS10	D14	GM-12020116	A13	GW-9X1/4X5/8-11	H07
FLH-5/16	C08	FW-SAE-3/8	D04	FWS12	D14	GM-12020120	A13	H1B	A03
FLS-30	B11	FW-SAE-4	D04	FWS3/8	D14	GM-12020126	A13	H1R-12	A05
FLS-40	B11	FW-SAE-5/16	D04	FWS5/16	D14	GM-12020320	A13	H1R-14	A05
FLT-BAT-123A	H13	FW-SAE-5/8	D04	FWS5/8	D14	GM-12020346	A13	H1R-38	A05
FLT-BAT-6VL	H13	FW-SAE-6	D04	FWS6	D14	GM-12020347	A13	H1R-56	A05
FLT-BAT-9V8	H13	FW-SAE-7/16	D04	FWS7/16	D14	GM-12020801	A12	HB-40	G09
FLT-BAT-AA24	H13	FW-SAE-7/8	D04	FWS8	D14	GM-12034046	A13	HB-40AST	G08
FLT-BAT-AAA24	H13	FW-SAE-8	D04	G1B	A03	GM-12034047	A13	HB-40METRIC	G09
FLT-BAT-C12	H13	FW-SAE-9/16	D04	G1R-12	A05	GM-12047581	A13	HB-80AST	G08
FLT-BAT-D12	H13	FW-USS-1	D04	G1R-14	A05	GM-12047665	A13	HB10-80METRIC	G09
FMX-20	B11	FW-USS-1-1/2	D04	G1R-38	A05	GM-12047767	A13	HB8-40AST	G08
FMX-30	B11	FW-USS-1-1/4	D04	G1R-56	A05	GM-12048074	A13	HB8-80AST	G08
FMX-40	B11	FW-USS-1/2	D04	GC-1/2	C10	GM-12048086	A12	HC-10	C09
FMX-50	B11	FW-USS-1/4	D04	GC-1/4	C10	GM-12066214	A13	HC-104	C09
FMX-60	B11	FW-USS-10	D04	GC-3/16	C10	GM-12089040	A12	HC-12	C09
FMXLP-20	B11	FW-USS-3/4	D04	GC-3/4	C10	GM-12089188	A12	HC-128	C09
FMXLP-25	B11	FW-USS-3/8	D04	GC-3/8	C10	GM-12089679	A12	HC-16	C09
FMXLP-30	B11	FW-USS-5/16	D04	GC-WB	C10	GM-12103881	A13	HC-20	C09
FMXLP-40	B11	FW-USS-5/8	D04	GCNT-W	A16	GM-12110236	A13	HC-24	C09
FMXLP-50	B11	FW-USS-7/16	D04	GF-KIT110	G15	GM-12110845	A13	HC-28	C09
FMXLP-60	B11	FW-USS-9/16	D04	GM-02965142	A13	GM-12110846	A13	HC-32	C09
FNW-12X2	D04	FW8-USS-1	D04	GM-02973407	A13	GM-12110847	A13	HC-36	C09
FNW-14X1	D04	FW8-USS-1/2	D04	GM-02989877	A13	GM-12110853	A13	HC-40	C09
FNW-14X112	D04	FW8-USS-1/4	D04	GM-06294493	A13	GM-12124304	A13	HC-44	C09
FNW-14X114	D04	FW8-USS-3/4	D04	GM-06294511	A13	GM-12124580	A12	HC-48	C09
FNW-316X1	D04	FW8-USS-3/8	D04	GM-0660T	A12	GM-12124581	A12	HC-52	C09

PART NUMBER INDEX

PART#	PAGE	PART#	PAGE	PART#	PAGE	PART#	PAGE	PART#	PAGE
HC-56	C09	HNC8-5/8	D05	HPC-02	D08	HSB3-32	H08	J-H9003	B05
HC-6	C09	HNC8-7/16	D05	HPC-03	D08	HSF-1	H08	J-H9004	B05
HC-60	C09	HNC8-7/8	D05	HPC-04	D09	J-1003	B02	J-H9004LL	B05
HC-64	C09	HNC8-9/16	D05	HPC-05	D09	J-1004	B02	J-H9005	B05
HC-72	C09	HNCFL-1/2	D05	HPC-06	D09	J-105	B02	J-H9006	B05
HC-8	C09	HNCFL-1/4	D05	HPC-07	D08	J-1073	B03	J-H9007	B05
HC-80	C09	HNCFL-10	D05	HPC-08	D09	J-1076	B03	J-H9007LL	B05
HC-88	C09	HNCFL-3/8	D05	HPC-09	D08	J-1141	B03	J-H9008	B05
HC-96	C09	HNCFL-5/16	D05	HPC-10	D08	J-1142	B03	J-NWE73	B03
HC-AST	G14	HNCFL-5/8	D05	HPC-11	D08	J-1154	B03	J-PR2	B02
HC-M10	C09	HNCS1/2	D14	HPC-13	D08	J-1156	B03	J-RS50	H13
HC-M4	C09	HNCS1/4	D14	HPC-14	D08	J-1157	B03	J-TS75	H13
HC-M6	C09	HNCS3/8	D14	HPC-15	D08	J-1157NA	B03	J1B	A03
HC-M8	C09	HNCS5/16	D14	HPC-16	D08	J-1176	B03	J1R-12	A05
HCSS-10	C09	HNCF5-1/2	D05	HPC-17	D08	J-1210/H1	B04	J1R-38	A05
HCSS-12	C09	HNCF5-3/8	D05	HPC-18	D08	J-1210/H3	B04	J1R-56	A05
HCSS-16	C09	HNCF5-5/16	D05	HPC-19	D09	J-1210055/H4	B05	JC6/2-ORG/BLK	C06
HCSS-20	C09	HNCF5-7/16	D05	HPC-21	D08	J-1255/H1	B04	JCR6/2-RED/BLK	C06
HCSS-24	C09	HNCF8-1/2	D05	HPC-22	D08	J-1255/H11	B05	JW-10/2	C04
HCSS-28	C09	HNCF8-1/4	D05	HPC-23	D08	J-1255/H3	B04	JW-12/2-BB	C04
HCSS-32	C09	HNCF8-3/8	D05	HPC-24	D08	J-1255/H7	B05	JW-12/2-GRY	C04
HCSS-36	C09	HNCF8-5/16	D05	HPC-25	D08	J-1270/H7	B05	JW-12/3	C04
HCSS-48	C09	HNCF8-5/8	D05	HPC-26	D08	J-1662	B03	JW-14/2-GRY	C04
HCSS-6	C09	HNCF8-7/16	D05	HPC-27	D08	J-1683	B03	JW-14/3	C04
HCSS-72	C09	HNM-10	D07	HPC-28	D08	J-1816	B04	JW-14/4	C04
HCSS-8	C09	HNM-12	D07	HPC-29	D09	J-1889	B04	JW-16/2	C04
HCSS-M10	C09	HNM-14	D07	HPC-30	D08	J-1893	B04	JW-16/3	C04
HCSS-M4	C09	HNM-16	D07	HPC-31	D08	J-1895	B02	JW-16/4	C04
HCSS-M6	C09	HNM-4	D07	HPC-32	D08	J-194	B04	JW-18/2D	C04
HCSS-M8	C09	HNM-5	D07	HPC-33	D08	J-198	B03	JW-8/2	C04
HMC14	H12	HNM-6	D07	HPC-36	D08	J-2057	B03	JW-BC10/2	C03
HMC38	H12	HNM-8	D07	HPC-KIT105	G12	J-3057	B02	JW-BC12/2	C03
HMC38L	H12	HNM10-10	D07	HR-30	B14	J-3156	B02	JW-BC12/3	C03
HMC516	H12	HNM10-12	D07	HR-30B	B14	J-3157	B02	JW-BC14/2	C03
HMC516L	H12	HNM10-14	D07	HR-49401	B14	J-382	B03	JW-BC14/3	C03
HMC716	H12	HNM10-6	D07	HR-70B	B14	J-3898	B03	JW-BC16/2	C03
HNC5-1	D05	HNM10-8	D07	HR-75102	B14	J-51	B02	JW-BC16/3	C03
HNC5-1/2	D05	HNPTC-1	D05	HR-75551	B14	J-53	B02	K1B	A03
HNC5-1/4	D05	HNPTC-1/2	D05	HR-87115	B14	J-57	B02	K1R-12	A05
HNC5-3/4	D05	HNPTC-1/4	D05	HR-87272	B14	J-63	B02	K1R-38	A05
HNC5-3/8	D05	HNPTC-3/4	D05	HR-87402	B14	J-67	B02	KNC-1/4	D05
HNC5-5/16	D05	HNPTC-3/8	D05	HR-87414	B14	J-70	B03	KNC-10	D05
HNC5-5/8	D05	HNPTC-5/16	D05	HR-87416	B14	J-795	B05	KNC-3/8	D05
HNC5-7/16	D05	HNPTC-5/8	D05	HR-87423	B14	J-85	B03	KNC-5/16	D05
HNC8-1	D05	HNPTC-7/16	D05	HR-87426	B14	J-86	B03	KNC-6	D05
HNC8-1/2	D05	HNPTC-7/8	D05	HR-BASE5	B14	J-888	B04	KNC-8	D05
HNC8-1/4	D05	HNPTC-9/16	D05	HR-PGTL5-24	B15	J-89	B02	L1B	A03
HNC8-3/4	D05	HO-10-250	A07	HR-SOCKET5	B14	J-90	B02	L1R-12	A05
HNC8-3/8	D05	HP-12	B15	HSB3-18	H08	J-912	B05	L1R-38	A05
HNC8-5/16	D05	HPC-01	D08	HSB3-24	H08	J-921	B05	LE-4321	H08

PART NUMBER INDEX

PART#	PAGE	PART#	PAGE	PART#	PAGE	PART#	PAGE	PART#	PAGE
LE-GOLD50D	H03	LE-VB8	H09	LWM-10	D07	MNCS1/4	D14	MSCPX-14112	D11
LE-GOLD5C	H03	LM-20010	E11	LWM-12	D07	MNCS10	D14	MSCPX-1412	D11
LE-J480	H09	LM-42145	E12	LWM-14	D07	MNCS6	D14	MSCPX-142	D11
LE-L01	H08	LM-47235	E11	LWM-16	D07	MNCS8	D14	MSCPX-1434	D11
LE-L02	H08	LM-47565	E12	LWM-4	D07	MNFS10	D14	MSCPX-61	D11
LE-L04	H08	LP-142R	D10	LWM-5	D07	MSCFSX1434	D15	MSCPX-6112	D11
LE-L05	H08	LP-143S	D10	LWM-6	D07	MSCFX-141	D11	MSCPX-612	D11
LE-L06	H08	LP-38212S	D10	LWM-8	D07	MSCFX-14112	D11	MSCPX-634	D11
LE-L10	H08	LP-516234R	D10	LWS1/2	D14	MSCFX-14114	D11	MSCPX-81	D11
LE-L12	H08	LP-516234S	D10	LWS1/4	D14	MSCFX-1412	D11	MSCPX-8112	D11
LE-L1200	H08	LPB-HN	D05	LWS10	D14	MSCFX-142	D11	MSCPX-812	D11
LE-L16	H08	LPB-SN	D05	LWS3/8	D14	MSCFX-1434	D11	MSCPX-834	D11
LE-L18	H08	LTKT-TOW	F13	LWS5/16	D14	MSCFXS141	D15	MSCPXS101	D15
LE-L20	H08	LW-1	D04	LWS6	D14	MSCFXS14112	D15	MSCPXS10112	D15
LE-L22	H08	LW-1/2	D04	LWS8	D14	MSCFXS14134	D15	MSCPXS1012	D15
LE-L24	H08	LW-1/4	D04	LYNP-316X1916	D10	MSCFXS142	D15	MSCPXS102	D15
LE-L28	H08	LW-10	D04	LYNP-516X134	D10	MSCFXS14212	D15	MSCPXS10212	D15
LE-L32	H08	LW-3/4	D04	LYNP-716X134	D10	MSCHWF-141	D11	MSCPXS103	D15
LE-L33	H08	LW-3/8	D04	MA-10448	H13	MSCHWF-1412	D11	MSCPXS1034	D15
LE-L36	H08	LW-5/16	D04	MA-51773	H13	MSCHWF-1434	D11	MSCPXS141	D15
LE-L38	H08	LW-5/8	D04	MA-MT51	H13	MSCHWF-381	D11	MSCPXS14112	D15
LE-L40	H08	LW-7/16	D04	MAX-20	B08	MSCHWF-5161	D11	MSCPXS14114	D15
LE-L44	H08	LW-8	D04	MAX-30	B08	MSCHWF-51612	D11	MSCPXS1412	D15
LE-L48	H08	LW-9/16	D04	MAX-40	B08	MSCHWF-51634	D11	MSCPXS142	D15
LE-L52	H08	LW8-1	D04	MAX-50	B08	MSCOXS101	D15	MSCPXS14212	D15
LE-L56	H08	LW8-1/2	D04	MAX-60	B08	MSCOXS10112	D15	MSCPXS143	D15
LE-L60	H08	LW8-1/4	D04	MAX-70	B08	MSCOXS1012	D15	MSCPXS1434	D15
LE-L64	H08	LW8-3/4	D04	MAX-80	B08	MSCOXS102	D15	MSCPXS144	D15
LE-L72	H08	LW8-3/8	D04	MBH-1/4	H12	MSCOXS10212	D15	MSCPXS61	D15
LE-P600	H08	LW8-5/16	D04	MBH-1/4X6	H12	MSCOXS103	D15	MSCPXS6112	D15
LE-PD56	H08	LW8-5/8	D04	MBX-ME3200	H03	MSCOXS1034	D15	MSCPXS612	D15
LE-R110	H09	LW8-7/16	D04	MBX-MP3500	H03	MSCOXS141	D15	MSCPXS62	D15
LE-R606	H09	LW8-7/8	D04	MBX-RE0023	H03	MSCOXS14112	D15	MSCPXS634	D15
LE-R610	H09	LW8-9/16	D04	MCK-0298	J08	MSCOXS14114	D15	MSCPXS81	D15
LE-R614	H09	LWE-1/2	D04	MCK-0300	J08	MSCOXS142	D15	MSCPXS8112	D15
LE-R618	H09	LWE-1/4	D04	MCK-0302	J08	MSCOXS14212	D15	MSCPXS812	D15
LE-R624	H09	LWE-10	D04	MCK-0304	J08	MSCOXS1434	D15	MSCPXS82	D15
LE-R636B	H09	LWE-3/8	D04	MCK-0310	J08	MSCOXS1434	D15	MSCPXS834	D15
LE-R656	H09	LWE-5/16	D04	MCK-0312	J08	MSCOXS144	D15	MSCTX-1412	D11
LE-R810	H09	LWE-7/16	D04	MCK-0314	J08	MSCOXS81	D15	MSCTX-1412	D11
LE-T418	H09	LWEI-1/4	D04	MCK-0325	J08	MSCOXS812	D15	MSCTX-1434	D11
LE-T424	H09	LWEI-10	D04	MHN-1024	D05	MSCOXS834	D15	MSFPX-101	D11
LE-T432	H09	LWEI-3/8	D04	MHN-1032	D05	MSCPX-101	D11	MSFPX-10112	D11
LE-VB1	H09	LWEI-5/16	D04	MHN-1224	D05	MSCPX-10112	D11	MSFPX-1012	D11
LE-VB11	H09	LWI-1/2	D04	MHN-1420	D05	MSCPX-10114	D11	MSFPX-1034	D11
LE-VB2	H09	LWI-1/4	D04	MHN-632	D05	MSCPX-1012	D11	MSFPXS101	D15
LE-VB3	H09	LWI-3/8	D04	MHN-832	D05	MSCPX-102	D11	MSFPXS10112	D15
LE-VB4	H09	LWI-5/16	D04	MMCO	A07	MSCPX-1034	D11	MSFPXS1012	D15
LE-VB6	H09	LWI-5/8	D04	MMFE	A07	MSCPX-1058	D11	MSFPXS102	D15
LE-VB7	H09	LWI-7/16	D04	MMFEB	A07	MSCPX-141	D11	MSFPXS10212	D15

PART NUMBER INDEX

PART#	PAGE	PART#	PAGE	PART#	PAGE	PART#	PAGE	PART#	PAGE
MSFPXS1034	D15	NPCB	A10	OP-A8RB	F06	OP-ST70RB	F05	P-11-902	E13
MSPX-KIT1600	G11	NPCBHL-ST	A10	OP-A91AB	F12	OP-ST75AB	F06	P-11-904	E13
MT-2	B17	NPCC	A10	OP-A91GB	F08	OP-ST8RB	F06	P-11-910	E13
MT-34	B17	NT-11	A17	OP-A91LW	F04	OP-ST90AB	F05	P-11-932	E12
MW-16	C10	NT-14	A17	OP-A91RB	F08	OP-ST90RB	F05	P-11-933	E12
MW-18	C10	NT-14HD	A17	OP-A9RB	F06	OP-ST9RB	F06	P-12-700	E13
NA-LED625-A	F15	NT-24HD	A17	OP-AL91AB	F04	OP-STL22RB	F02	P-12-701U	E13
NA-MMBSLEDFLM-C/A	F15	NT-36HD	A17	OP-AL91RB	F04	OP-STL22RCB	F02	P-12-702	E13
NA-MMBSLEDFLM-C/R	F15	NT-4	A17	OP-BA44FNL	F09	OP-STL42RB	F02	P-12-703	E13
NA-MMBSLEDFLP-C/A	F15	NT-6	A17	OP-BA44FNRR	F09	OP-STL43RB	F02	P-12-705	E13
NA-MMBSLEDFLP-C/R	F15	NT-7	A17	OP-BK45BB	F12	OP-STL72AB	F02	P-12-706	E13
NNC-1/2	D05	NT-7BLU	A16	OP-BL70BB	F12	OP-STL72RB	F02	P-12-707	E13
NNC-1/4	D05	NT-7GRN	A16	OP-BUL52CB	F04	OP-STL8RB	F03	P-12-711U	E13
NNC-10	D05	NT-7HD	A17	OP-BUL53CB	F04	OP-STL90AB	F03	P-12-716	E12
NNC-3/4	D05	NT-7L	A17	OP-BUL72CB	F04	OP-STL90RB	F03	P-12-717	E12
NNC-3/8	D05	NT-7ORG	A16	OP-LP51CB	F10	OP-STL9RB	F03	P-12-718	E12
NNC-5/16	D05	NT-7PNK	A16	OP-LP52CB	F10	P-11-400	E14	P-12-719	E12
NNC-5/8	D05	NT-7YEL	A16	OP-LP5SB	F14	P-11-402	E14	P-12-729	E12
NNC-7/16	D05	NT-B11	A17	OP-MC35AB	F07	P-11-403	E14	P-12-751EV	E11
NNC-9/16	D05	NT-B14	A17	OP-MC35RB	F07	P-11-404	E14	P-21-458	E06
NNCS1/2	D14	NT-B14HD	A17	OP-MC36AB	F07	P-11-408	E14	P-24-359	E06
NNCS1/4	D14	NT-B24HD	A17	OP-MC36RB	F07	P-11-409	E14	P-24-360	E06
NNCS10	D14	NT-B36HD	A17	OP-MC38AB	F07	P-11-410	E14	P-25-358	E06
NNCS3/8	D14	NT-B4	A17	OP-MC38RB	F07	P-11-6-3	E14	P-25-370	E03
NNCS5/16	D14	NT-B6	A17	OP-MC42AB	F08	P-11-604	E14	P-25-371	E03
NNCS6	D14	NT-B7	A17	OP-MC42RB	F08	P-11-605	E14	P-31-104	E08
NNCS7/16	D14	NT-B7FCT	A17	OP-MC44AB	F07	P-11-607	E14	P-31-114	E08
NNCS8	D14	NT-B7HD	A17	OP-MC53AB	F07	P-11-608	E14	P-31-166-001	E09
NNF-1/2	D05	NT-B7L	A17	OP-MC53RB	F07	P-11-609	E14	P-31-173-104	E09
NNF-1/4	D05	NT-B7X	A17	OP-MC57AB	F07	P-11-617	E14	P-31-180	E08
NNF-10	D05	NT-BH11	A17	OP-MC57RB	F07	P-11-627	E14	P-31-242	E08
NNF-3/4	D05	NT-BH14HD	A17	OP-MC65AB	F08	P-11-700	E13	P-31-297	E08
NNF-3/8	D05	NT-BH7	A17	OP-MC65RB	F08	P-11-702	E13	P-31-302	E08
NNF-5/16	D05	NT-H11	A17	OP-MC99RB	F09	P-11-704	E13	P-31-600-103	E09
NNF-7/16	D05	NT-H14	A17	OP-MCL45AB	F03	P-11-710	E13	P-31-602	E08
NNFS1/2	D14	NT-H14HD	A17	OP-MCL45RB	F03	P-11-720	E13	P-31-610	E08
NNFS1/4	D14	NT-H7	A17	OP-MCL51RB	F04	P-11-721	E13	P-33-104	E07
NNFS10	D14	NT-KIT600C	G07	OP-MCL55AB	F03	P-11-723	E13	P-33-105	E07
NNFS3/8	D14	NT-KIT700BL	G07	OP-MCL55RB	F03	P-11-724	E13	P-33-402	E05
NNFS5/16	D14	NTBH-B9	A17	OP-MCL57AB	F03	P-11-737	E13	P-34-212	E02
NNM-10	D07	OP-A45CB	F11	OP-MCL57RB	F03	P-11-761	E13	P-34-213	E02
NNM-5	D07	OP-A45GB	F11	OP-MCL75AB	F04	P-11-762	E13	P-34-216	E02
NNM-6	D07	OP-A45PB	F11	OP-MCL75RB	F04	P-11-763	E13	P-34-219	E02
NNM-8	D07	OP-A46PB	F11	OP-MCL93RB	F04	P-11-771	E13	P-34-220	E02
NO-A202	J09	OP-A47PB	F11	OP-RT150711B	B17	P-11-850	E15	P-34-222	E02
NO-E403	J09	OP-A49PB	F11	OP-ST44RB	F05	P-11-851	E15	P-34-230	E05
NO-E800	J09	OP-A54GB	F11	OP-ST45RB	F05	P-11-852	E15	P-34-240	E05
NO-NCP2TM	J09	OP-A55GB	F12	OP-ST46RB	F05	P-11-893	E12	P-34-360	E05
NPBA	A10	OP-A65PB	F10	OP-ST64RB	F05	P-11-898	E12	P-34-500	E03
NPBA-S	A10	OP-A70GB	F12	OP-ST70AB	F05	P-11-900	E13	P-34-513	E03

PART NUMBER INDEX

PART#	PAGE	PART#	PAGE	PART#	PAGE	PART#	PAGE	PART#	PAGE
P-34-571	E02	P-54-150	B12	PM-114A	F07	PM-417SA-2	F15	PMCN-2	H12
P-34-571L	E02	P-54-215	B12	PM-114R	F07	PM-417SR-1	F15	PT-16720	B16
P-34-571Q	E02	P-54-220	B12	PM-115A	F07	PM-420SA-1	F15	PT-1700	B16
P-34-572	E02	P-54-225	B12	PM-115R	F07	PM-420SA-2	F15	PT-33	B16
P-34-573	E02	P-54-230	B12	PM-134-15A	F08	PM-421-18	F12	PT-35BLU	B16
P-34-574	E02	P-54-240	B12	PM-134-15R	F08	PM-421-49	F11	PT-35BRN	B16
P-34-575	E02	P-54-250	B12	PM-135A	F08	PM-421-491	F11	PT-35GRN	B16
P-34-575Q	E02	P-54-510PL	B12	PM-135R	F08	PM-421A	F05	PT-35ORG	B16
P-34-576	E02	P-54-520	B12	PM-138-15A	F08	PM-421KR	F05	PT-35RED	B16
P-34-577	E02	P-54-530	B12	PM-138-15R	F08	PM-421R	F05	PT-35WHT	B16
P-34-580	E02	P-54-540	B12	PM-138A	F08	PM-426-18	F11	PT-35YEL	B16
P-34-580Q	E02	P-54-631PL	B12	PM-138R	F08	PM-426A	F05	PT-88	B16
P-34-586Q	E02	P-54-641PL	B12	PM-142-18	F07	PM-426KR	F05	PT-PKGC	B17
P-34-591Q	E02	P-54-651PL	B12	PM-142-49	F07	PM-426R	F05	PW-R	G15
P-34-592	E02	P-54-725	B12	PM-143-18	F12	PM-427R	F05	PW10-BLK	C02
p-34-592	E10	P-54-870PL	B12	PM-143A	F07	PM-428	F06	PW10-BLU	C02
P-34-592Q	E02	PB-128	J09	PM-143R	F07	PM-428S	F06	PW10-BRN	C02
P-35-300	E05	PB-16	J09	PM-146-18	F07	PM-431-49	F11	PW10-GRN	C02
P-35-306	E05	PB-ATC-4	J09	PM-146A	F07	PM-431-491	F11	PW10-GRY	C02
P-35-331	E05	PB-ATC-404	J09	PM-146R	F07	PM-431R	F06	PW10-ORG	C02
P-41-706	E16	PB-CBD-16	J09	PM-150-09	F12	PM-436	F10	PW10-RED	C02
P-41-820	E16	PB-SL-16	J09	PM-150-092	F13	PM-436B	F10	PW10-TAN	C02
P-41-822	E16	PC-1	C10	PM-150-102	F13	PM-439	F10	PW10-WHT	C02
P-42-151	E10	PC-1/2	C10	PM-150-141	F12	PM-440	F06	PW10-YEL	C02
P-42-159	E10	PC-1/4	C10	PM-150-18	F12	PM-440-09	F13	PW10D-BLK	C02
P-42-201	E10	PC-1/8	C10	PM-150-19	F15	PM-440-15	F06	PW10D-BLU	C02
P-42-203	E10	PC-3/16	C10	PM-150-49	F11	PM-440L	F06	PW10D-BRN	C02
P-42-302	E10	PC-3/4	C10	PM-150A	F08	PM-445	F06	PW10D-GRN	C02
P-42-308	E10	PC-3/8	C10	PM-150C	F10	PM-465-1	B17	PW10D-ORG	C02
P-51-303	E06	PC-5/16	C10	PM-150R	F08	PM-505K	F14	PW10D-RED	C02
P-51-902	E06	PC-5/8	C10	PM-153SA-1	F15	PM-507	F09	PW10D-WHT	C02
P-51-904	E06	PC-B1/2	C10	PM-153SA-2	F15	PM-55-15R	F06	PW10D-YEL	C02
P-52-138	E14	PC-B1/4	C10	PM-154-09K	F10	PM-56-15R	F08	PW10M-BLK	C02
P-52-139	E14	PC-B1/8	C10	PM-154-11K	F10	PM-576	B13	PW10M-BLU	C02
P-52-244	E10	PC-B3/16	C10	PM-154A	F08	PM-603L	F13	PW10M-BRN	C02
P-52-245	E10	PC-B3/4	C10	PM-154C	F10	PM-608	F13	PW10M-GRN	C02
P-52-246	E10	PC-B3/8	C10	PM-154KA	F08	PM-V504HF	F09	PW10M-RED	C02
P-52-247	E10	PC-B5/16	C10	PM-154KR	F08	PMC-1	H12	PW10M-WHT	C02
P-52-248	E10	PC-B5/8	C10	PM-154R	F08	PMC-1XXL	H12	PW10M-YEL	C02
P-52-249	E10	PG-1-3/8	D18	PM-162-49	F03	PMC-2	H12	PW12-BLK	C02
P-52-259	E10	PG-1/2	D18	PM-166A	F03	PMC-2L	H12	PW12-BLU	C02
P-52-271	E10	PG-1/4	D18	PM-313-2RA	F06	PMC-2XL	H12	PW12-BRN	C02
P-52-307	E09	PG-1/8	D18	PM-352A	F06	PMC-2XXL	H12	PW12-DKGRN	C02
P-52-315	E09	PG-11/16	D18	PM-412-07	F11	PMC-2XXXL	H12	PW12-GRN	C02
P-52-324	E09	PG-3/4	D18	PM-413-07	B15	PMC-3	H12	PW12-GRY	C02
P-52-623	E07	PG-3/8	D18	PM-415	F09	PMC-3L	H12	PW12-ORG	C02
P-54-115	B12	PG-5/8	D18	PM-416	F09	PMC-3XXL	H12	PW12-PNK	C02
P-54-120	B12	PG-KIT150	G13	PM-417-49	F15	PMC-3XXXL	H12	PW12-RED	C02
P-54-130	B12	PM-107-3R	F09	PM-417R-2	F02	PMC-ACR2L	H12	PW12-TAN	C02
P-54-140	B12	PM-107WA	F08	PM-417SA-1	F15	PMC-KIT30	G14	PW12-WHT	C02

PART NUMBER INDEX

PART#	PAGE	PART#	PAGE	PART#	PAGE	PART#	PAGE	PART#	PAGE
PW12-YEL	C02	PW14M-GRN	C02	PW18-BRN	C02	PW8M-WHT	C02	RG-KIT130	G13
PW12D-BLK	C02	PW14M-GRY	C02	PW18-GRN	C02	PWPKG-10BLK	C02	RG1214	D18
PW12D-BLU	C02	PW14M-ORG	C02	PW18-GRY	C02	PWPKG-10BLU	C02	RG1218	D18
PW12D-BRN	C02	PW14M-PNK	C02	PW18-ORG	C02	PWPKG-10BRN	C02	RG12332	D18
PW12D-GRN	C02	PW14M-PUR	C02	PW18-PNK	C02	PWPKG-10GRN	C02	RG14116	D18
PW12D-ORG	C02	PW14M-RED	C02	PW18-PUR	C02	PWPKG-10ORG	C02	RG141161	D18
PW12D-RED	C02	PW14M-TAN	C02	PW18-RED	C02	PWPKG-10RED	C02	RG18332	D18
PW12D-WHT	C02	PW14M-WHT	C02	PW18-WHT	C02	PWPKG-10WHT	C02	RG316116	D18
PW12D-YEL	C02	PW14M-YEL	C02	PW18-YEL	C02	PWPKG-10YEL	C02	RG31614	D18
PW12M-BLK	C02	PW16-BLK	C02	PW18D-BLK	C02	PWPKG-12BLK	C02	RG316332	D18
PW12M-BLU	C02	PW16-BLU	C02	PW18D-BLU	C02	PWPKG-12BLU	C02	RG34116	D18
PW12M-BRN	C02	PW16-BRN	C02	PW18D-BRN	C02	PWPKG-12BRN	C02	RG3414	D18
PW12M-GRN	C02	PW16-DKBLU	C02	PW18D-DKBLU	C02	PWPKG-12GRN	C02	RG34446114	D18
PW12M-GRY	C02	PW16-DKGRN	C02	PW18D-DKGRN	C02	PWPKG-12ORG	C02	RG38116	D18
PW12M-ORG	C02	PW16-GRN	C02	PW18D-GRN	C02	PWPKG-12RED	C02	RG381161	D18
PW12M-RED	C02	PW16-GRY	C02	PW18D-GRY	C02	PWPKG-12WHT	C02	RG3814	D18
PW12M-WHT	C02	PW16-ORG	C02	PW18D-ORG	C02	PWPKG-12YEL	C02	RG516116	D18
PW12M-YEL	C02	PW16-PNK	C02	PW18D-PNK	C02	PWPKG-14BLK	C02	RG51614	D18
PW14-BLK	C02	PW16-PUR	C02	PW18D-PUR	C02	PWPKG-14BLU	C02	RG51618	D18
PW14-BLU	C02	PW16-RED	C02	PW18D-RED	C02	PWPKG-14BRN	C02	RG532116	D18
PW14-BRN	C02	PW16-WHT	C02	PW18D-TAN	C02	PWPKG-14GRN	C02	RG532332	D18
PW14-DKBLU	C02	PW16-YEL	C02	PW18D-WHT	C02	PWPKG-14ORG	C02	RG58116	D18
PW14-DKGRN	C02	PW16D-BLK	C02	PW18D-YEL	C02	PWPKG-14RED	C02	RG5818	D18
PW14-GRN	C02	PW16D-BLU	C02	PW18M-BLK	C02	PWPKG-14WHT	C02	RG6-129021	H02
PW14-GRY	C02	PW16D-BRN	C02	PW18M-BLU	C02	PWPKG-14YEL	C02	RG6-322990	C06
PW14-ORG	C02	PW16D-DKBLU	C02	PW18M-BRN	C02	PWPKG-16BLK	C02	RG6-323003	C06
PW14-PNK	C02	PW16D-DKGRN	C02	PW18M-DKGRN	C02	PWPKG-16BLU	C02	RG6-32412	C06
PW14-PUR	C02	PW16D-GRN	C02	PW18M-GRN	C02	PWPKG-16BRN	C02	RG6Q	C06
PW14-RED	C02	PW16D-GRY	C02	PW18M-GRY	C02	PWPKG-16GRN	C02	RG6Q/2	C06
PW14-TAN	C02	PW16D-ORG	C02	PW18M-ORG	C02	PWPKG-16ORG	C02	RIC-KIT230L	G12
PW14-WHT	C02	PW16D-PNK	C02	PW18M-PNK	C02	PWPKG-16RED	C02	RIC-L1	C09
PW14-YEL	C02	PW16D-PUR	C02	PW18M-PUR	C02	PWPKG-16WHT	C02	RIC-L1-1/2	C09
PW14D-BLK	C02	PW16D-RED	C02	PW18M-RED	C02	PWPKG-16YEL	C02	RIC-L1-1/4	C09
PW14D-BLU	C02	PW16D-WHT	C02	PW18M-WHT	C02	PWPKG-18BLK	C02	RIC-L1-1/4SLV	C09
PW14D-BRN	C02	PW16D-YEL	C02	PW18M-YEL	C02	PWPKG-18BLU	C02	RIC-L1-3/4SLV	C09
PW14D-DKBLU	C02	PW16M-BLK	C02	PW20-BLK	C02	PWPKG-18BRN	C02	RIC-L1/2	C09
PW14D-DKGRN	C02	PW16M-BLU	C02	PW20-RED	C02	PWPKG-18GRN	C02	RIC-L1/4	C09
PW14D-GRN	C02	PW16M-BRN	C02	PW20-WHT	C02	PWPKG-18ORG	C02	RIC-L2-1/2SLV	C09
PW14D-GRY	C02	PW16M-DKBLU	C02	PW20D-RED	C02	PWPKG-18RED	C02	RIC-L2SLV	C09
PW14D-ORG	C02	PW16M-DKGRN	C02	PW20M-BLK	C02	PWPKG-18WHT	C02	RIC-L3/4	C09
PW14D-PNK	C02	PW16M-GRN	C02	PW20M-RED	C02	PWPKG-18YEL	C02	RIC-L3/4SLV	C09
PW14D-PUR	C02	PW16M-GRY	C02	PW20M-WHT	C02	RC12/2	C06	RIC-L3/8	C09
PW14D-RED	C02	PW16M-ORG	C02	PW8-BLK	C02	RC14/2	C06	RIC-L3SLV	C09
PW14D-TAN	C02	PW16M-PNK	C02	PW8-RED	C02	RC14/3	C06	RIC-L5/16	C09
PW14D-WHT	C02	PW16M-PUR	C02	PW8-WHT	C02	RC14/4	C06	RIC-L5/8	C09
PW14D-YEL	C02	PW16M-RED	C02	PW8D-BLK	C02	RC16/2	C06	RIC-L7/8	C09
PW14M-BLK	C02	PW16M-WHT	C02	PW8D-RED	C02	RC16/3	C06	RIC-S1	C09
PW14M-BLU	C02	PW16M-YEL	C02	PW8D-WHT	C02	RC16/4	C06	RIC-S1-1/2SLV	C09
PW14M-BRN	C02	PW18-BLK	C02	PW8M-BLK	C02	RC18/2	C06	RIC-S1/2	C09
PW14M-DKBLU	C02	PW18-BLU	C02	PW8M-RED	C02	RC18/4	C06	RIC-S1/2SLV	C09

PART NUMBER INDEX

PART#	PAGE	PART#	PAGE	PART#	PAGE	PART#	PAGE	PART#	PAGE
RIC-S1/4	C09	SE-620-1506	J07	SMSFS-8212	D12	SMSOXS1034	D15	SMSPS-1012	D12
RIC-S1/4SLV	C09	SE-620-1557	J07	SMSFS-83	D12	SMSOXS121	D15	SMSPS-61	D12
RIC-S1SLV	C09	SFE-7-1/2	B10	SMSFS-834	D12	SMSOXS12112	D15	SMSPSBLK-81	D12
RIC-S2SLV	C09	SFE-B14	B10	SMSFXS101	D15	SMSOXS12114	D15	SMSPSBLK-8112	D12
RIC-S3/16	C09	SFE-B20	B10	SMSFXS10112	D15	SMSOXS122	D15	SMSPX-101	D12
RIC-S3/4	C09	SFE-B30	B10	SMSFXS10114	D15	SMSOXS141	D15	SMSPX-10112	D12
RIC-S3/4SLV	C09	SFE-B9	B10	SMSFXS1034	D15	SMSOXS14112	D15	SMSPX-10114	D12
RIC-S3/8	C09	SJOOW-10/3	C07	SMSFXS141	D15	SMSOXS142	D15	SMSPX-1012	D12
RIC-S3/8SLV	C09	SJOOW-12/3	C07	SMSFXS14112	D15	SMSOXS14212	D15	SMSPX-102	D12
RIC-S5/16	C09	SJOOW-14/2	C07	SMSFXS61	D15	SMSOXS143	D15	SMSPX-1034	D12
RIC-S5/8	C09	SJOOW-14/3	C07	SMSFXS634	D15	SMSOXS61	D15	SMSPX-1058	D12
RIC-S5/8SLV	C09	SJOOW-16/2	C07	SMSFXS81	D15	SMSOXS6112	D15	SMSPX-121	D12
RIC-S7/8	C09	SJOOW-16/3	C07	SMSFXS8112	D15	SMSOXS612	D15	SMSPX-12112	D12
RP-116X1	D10	SJOOW-18/3	C07	SMSFXS8114	D15	SMSOXS634	D15	SMSPX-12114	D12
RP-116X12	D10	SL-314	A15	SMSFXS812	D15	SMSOXS81	D15	SMSPX-1212	D12
RP-14X1	D10	SL-A3M-FE	A15	SMSFXS834	D15	SMSOXS8112	D15	SMSPX-1234	D12
RP-14X112	D10	SL-B3M	A15	SMSHW-101	D12	SMSOXS8114	D15	SMSPX-141	D12
RP-14X2	D10	SL-B3M-FE	A15	SMSHW-1012	D12	SMSOXS812	D15	SMSPX-14112	D12
RP-14X212	D10	SL-B3M-WP	A15	SMSHW-1058	D12	SMSOXS82	D15	SMSPX-1412	D12
RP-14X34	D10	SL-BR3M	A15	SMSHW-141	D12	SMSOXS834	D15	SMSPX-142	D12
RP-18X1	D10	SL-BU3M	A15	SMSHW-14112	D12	SMSOXS834	D15	SMSPX-142	D12
RP-18X112	D10	SL-C3M-FE	A15	SMSHW-14114	D12	SMSOXS834	D15	SMSPX-1434	D12
RP-18X12	D10	SL-R3M	A15	SMSHW-1434	D12	SMSOXS834	D15	SMSPX-81	D12
RP-316X1	D10	SL-R3M-2	A15	SMSHW-81	D12	SMSOXS834	D15	SMSPX-8112	D12
RP-316X112	D10	SL-R3M-3	A15	SMSHW-82	D12	SMSOXS834	D15	SMSPX-812	D12
RP-316X2	D10	SL-UR	A15	SMSHW-834	D12	SMSOXS834	D15	SMSPX-812	D12
RP-316X34	D10	SL-W3M	A15	SMSHWI-101	D12	SMSOXS834	D15	SMSPX-834	D12
RP-332X1	D10	SL-Y3M	A15	SMSHWI-10112	D12	SMSOXS834	D15	SMSPX-858	D12
RP-332X112	D10	SLD-11604	A09	SMSHWI-1012	D12	SMSOXS834	D15	SMSPX-KIT-L	G10
RP-332X12	D10	SLD-11649	A09	SMSHWI-1034	D12	SMSOXS834	D15	SMSPX-101	D12
RP-532X1	D10	SLD-12406	A09	SMSHWI-141	D12	SMSOXS834	D15	SMSPX-1012	D12
RP-532X112	D10	SLD-15604	A09	SMSHWI-14112	D12	SMSOXS834	D15	SMSPX-1012	D12
RP-532X12	D10	SLD-21945	A09	SMSHWI-1412	D12	SMSOXS834	D15	SMSPX-1034	D12
RP-532X2	D10	SLD-51053	A09	SMSHWI-142	D12	SMSOXS834	D15	SMSPX-121	D15
RP-532X34	D10	SMA-5/16	A18	SMSHWI-1434	D12	SMSOXS834	D15	SMSPX-12112	D15
RP-KIT600	G14	SMA-5/16L	A18	SMSHWI-5161	D12	SMSOXS834	D15	SMSPX-1212	D15
SE-16-286	J07	SMC-1	H12	SMSHWI-516112	D12	SMSOXS834	D15	SMSPX-1234	D12
SE-16-81	J07	SMC-2	H12	SMSHWI-516114	D12	SMSOXS834	D15	SMSPX-141	D15
SE-16-899	J07	SMC-2L	H12	SMSHWI-51612	D12	SMSOXS834	D15	SMSPX-14112	D15
SE-620-1407	J07	SMC-2XL	H12	SMSHWI-51634	D12	SMSOXS834	D15	SMSPX-14114	D15
SE-620-1413	J07	SMC-2XXXL	H12	SMSHWI-8112	D12	SMSOXS834	D15	SMSPX-1058	D12
SE-620-1415	J07	SMC-3L	H12	SMSHWI-8114	D12	SMSOXS834	D15	SMSPX-121	D12
SE-620-1418	J07	SMC-3XL	H12	SMSHWI-812	D12	SMSOXS834	D15	SMSPX-12112	D15
SE-620-1423	J07	SMSFQ-81	D12	SMSHWI-834	D12	SMSOXS834	D15	SMSPX-102	D12
SE-620-1431	J07	SMSFQ-8112	D12	SMSOXS-KIT	G10	SMSOXS834	D15	SMSPX-1034	D12
SE-620-1433	J07	SMSFQ-82	D12	SMSOXS101	D15	SMSOXS834	D15	SMSPX-121	D12
SE-620-1443	J07	SMSFS-612	D12	SMSOXS10112	D15	SMSOXS834	D15	SMSPX-1212	D15
SE-620-1450	J07	SMSFS-8112	D12	SMSOXS10114	D15	SMSOXS834	D15	SMSPX-1234	D12
SE-620-1501	J07	SMSFS-8114	D12	SMSOXS1012	D15	SMSOXS834	D15	SMSPX-141	D15
SE-620-1505	J07	SMSFS-812	D12	SMSOXS102	D15	SMSOXS834	D15	SMSPX-14112	D15
				SMSOXS102	D15	SMSOXS834	D15	SMSPX-14114	D15

PART NUMBER INDEX

PART#	PAGE	PART#	PAGE	PART#	PAGE	PART#	PAGE	PART#	PAGE
SMSPX5142	D15	ST-1/2R	C08	ST-MWKIT120	G04	TS-101	D13	TSB-141	D13
SMSPX514212	D15	ST-1/4	C08	ST-MWKIT45	G04	TS-10112	D13	TSB-14112	D13
SMSPX51434	D15	ST-1/8	C08	ST-T3/4	B16	TS-10114	D13	TSB-81	D13
SMSPX561	D15	ST-14112	D13	SW-12/2	C06	TS-1012	D13	TSB-8112	D13
SMSPX56112	D15	ST-1R	C08	SW-16/2	C06	TS-102	D13	TSB-8114	D13
SMSPX56114	D15	ST-3/16	C08	SW-18/2	C06	TS-1034	D13	TSB-812	D13
SMSPX5612	D15	ST-3/32	C08	TC-12/6-10/1	C03	TS-121	D13	TSB-834	D13
SMSPX5634	D15	ST-3/4	C08	TC-14/4	C03	TS-12112	D13	TSB-BWX81	D13
SMSPX5658	D15	ST-3/4R	C08	TC-14/6	C03	TS-122	D13	TSB-BWX834	D13
SMSPX581	D15	ST-3/8	C08	TC-14/7	C03	TS-1234	D13	TSB-PX81	D13
SMSPX58112	D15	ST-3/8R	C08	TC-16/4	C03	TS-141	D13	TSB-PX8112	D13
SMSPX58114	D15	ST-GUN	C08	TC-16/6	C03	TS-14114	D13	TSB-PX812	D13
SMSPX5812	D15	ST-MW1	C08	TC-7ABS	C03	TS-142	D13	TSB-PX834	D13
SMSPX582	D15	ST-MW1/2	C08	TC-7RV	C03	TS-143	D13	TSB-RXW81	D13
SMSPX5834	D15	ST-MW1/2C	C08	TC-BLU14/6	C03	TS-1434	D13	TSB-RXW812	D13
SMSPX5858	D15	ST-MW1/2R	C08	TC-BLU14/7	C03	TS-612	D13	TSB-RXW834	D13
SMSRXWB-81	D12	ST-MW1/4	C08	TCA-16/5X20NE	C03	TS-634	D13	TT-21-335	E16
SMSRXWB-8112	D12	ST-MW1/4C	C08	TCA-16/5X20NE	E11	TS-638	D13	TT-210331	E16
SMSRXWB-812	D12	ST-MW1/4R	C08	TD-10	C10	TS-81	D13	TT-210333	E16
SMSRXWB-834	D12	ST-MW1/8	C08	TD-15	C10	TS-8112	D13	TT-210339	E16
SMSRXWB-858	D12	ST-MW1/8R	C08	TD-21	C10	TS-8114	D13	TT-210350	E16
SMSSQ-KIT2400	G10	ST-MW1012	C08	TD-31	C10	TS-812	D13	TT-210504	E16
SN-6	D05	ST-MW12PKG	C08	TE-2010	E11	TS-834	D13	TT-211200	F16
SN-8	D05	ST-MW12RPKG	C08	TE-2010A	E11	TS-FX12212E	D13	TT-211300	F16
SPL-1/2	C07	ST-MW1416	C08	TE-2026	E11	TS-FX14234E	D13	TT-211820-02	F16
SPL-1/4	C07	ST-MW14PKG	C08	TE-7000	E09	TS-KIT825L	G11	TT-211823-02	F16
SPL-1/8	C07	ST-MW14RPKG	C08	TE-7001	E09	TS-PSQ81	D13	TT-211832-02	F16
SPL-1HD	C07	ST-MW1820	C08	TE-9030	E11	TS-PSQ8112	D13	TT-211832-03	F16
SPL-2	C07	ST-MW1PKG	C08	TFT-520	B17	TS-PSQ812	D13	TT-220110-02	F16
SPL-3/8	C07	ST-MW1R	C08	TH-24Y	F14	TS-PSQ834	D13	TT-220200-02	F16
SPL-5/16	C07	ST-MW1RPKG	C08	TH-29Y	F14	TS-PX101	D13	TT-413201-05	F16
SPL-5/8	C07	ST-MW3/16	C08	THRC-1/2	D13	TS-PX10112	D13	TT-420200-02	F16
SPL-HT1	C07	ST-MW3/16C	C08	THRC-1/4	D13	TS-PX1012	D13	TT-439290	F16
SPL-HT1-1/2	C07	ST-MW3/16R	C08	THRC-3/8	D13	TS-PX1034	D13	TT-439411	F16
SPL-HT1-1/4	C07	ST-MW3/4	C08	THRC-5/16	D13	TS-PX61	D13	UNC-1/4	D05
SPL-HT1-5/8	C07	ST-MW3/4R	C08	TK-21	G03	TS-PX612	D13	UNC-3/8	D05
SPL-HT1/2	C07	ST-MW3/8	C08	TK-21C	G03	TS-PX634	D13	UNC-5/16	D05
SPL-HT1/4	C07	ST-MW3/8C	C08	TK-21ST	G04	TS-PX638	D13	VELCRO-1BLK	B17
SPL-HT3/4	C07	ST-MW3/8R	C08	TK-21STX	G04	TS-PX81	D13	VELCRO-2BLK	B17
SPL-HT3/8	C07	ST-MW316PKG	C08	TMC-15	H12	TS-PX8112	D13	VELCRO-BLK1H	B17
SPL-HT5/8	C07	ST-MW316RPKG	C08	TMC-15L	H12	TS-PX812	D13	VELCRO-BLK1L	B17
SPL-T08	C07	ST-MW34PKG	C08	TMC-20	H12	TS-PX834	D13	VELCRO-BLK2H	B17
SPL-T15	C07	ST-MW34RPKG	C08	TMC-20L	H12	TS-RWX81	D13	VELCRO-BLK2L	B17
SPL-T20	C07	ST-MW38PKG	C08	TMC-25	H12	TS-RWX834	D13	VH-3/32	C08
SPN-SIL	H14	ST-MW38RPKG	C08	TMC-25L	H12	TS-RXW812	D13	VH-5/32	C08
SPN-SIL-90	H14	ST-MWHD1	C08	TMC-27	H12	TS-SSKIT600	G11	VH-7/32	C08
SPW-C	H14	ST-MWHD1R	C08	TMC-30	H12	TS-TOC101	D13	VH-7/64	C08
ST-1	C08	ST-MWHD3/4	C08	TMC-30L	H12	TSB-101	D13	VH-9/32	C08
ST-1/16	C08	ST-MWHD3/4R	C08	TMC-40	H12	TSB-1012	D13	VHC-KIT90	G15
ST-1/2	C08	ST-MWHD3/8	C08	TMC-40L	H12	TSB-1034	D13	W-1003	B02

PART NUMBER INDEX

PART#	PAGE	PART#	PAGE	PART#	PAGE	PART#	PAGE	PART#	PAGE
W-1004	B02	W-2057	B03	W-6052	B06	W-PR2	B02		
W-1034	B03	W-2057NA	B03	W-623	B02	W-PR3	B02		
W-105	B02	W-211-2	B04	W-63	B02	W-PR7	B02		
W-1073	B03	W-212-2	B04	W-67	B02	W-RS100	H13		
W-1076	B03	W-222	B04	W-68	B02	W-RS60	H13		
W-11005	B05	W-2357	B03	W-73	B03	W-RS75	H13		
W-11006	B03	W-2357NA	B03	W-74	B03	WB-2023	E11		
W-11009	B03	W-24	B04	W-7400	B06	WB-403026	F13		
W-1129	B03	W-2470/H3	B04	W-7414Y	B06	WB-403076	F13		
W-1141	B03	W-2475/H4	B05	W-756	B04	WB-403336	F13		
W-1142	B03	W-24NA	B04	W-795	B05	WB-403348	F13		
W-1154	B03	W-3057	B02	W-880	B04	WB-5077001	E13		
W-1155	B02	W-3057NA	B02	W-881	B04	WB-5077003	E13		
W-1156	B03	W-3156	B02	W-886	B04	WB-5077004	E13		
W-1156DC	B03	W-3157	B02	W-889	B04	WB-5077070	E13		
W-1156NA	B03	W-3157NA	B02	W-89	B02	WB-5077071	E13		
W-1157	B03	W-327	B03	W-890	B04	WB-5085315	E11		
W-1157NA	B03	W-330	B03	W-891	B03	WB-80500	E11		
W-1176	B03	W-3357	B02	W-894	B04	WC-1	C04		
W-1195	B02	W-356	B02	W-90	B02	WC-1/0	C04		
W-1196	B02	W-37	B03	W-904	B05	WC-1/0R	C04		
W-1203	B03	W-4000	B06	W-906	B05	WC-2	C04		
W-1210/H1	B04	W-4114LL	B02	W-912	B05	WC-2/0	C04		
W-1210/H3	B04	W-4157LL	B02	W-916	B05	WC-2/0R	C04		
W-12100	B04	W-44	B04	W-916NA	B05	WC-2R	C04		
W-1237/H1	B04	W-4406	B06	W-921	B05	WC-3/0	C04		
W-1251	B02	W-4411	B06	W-93	B03	WC-3/0R	C04		
W-1255/H1	B04	W-4411-1	B06	W-94	B03	WC-4	C04		
W-1255/H3	B04	W-4411-MP	B06	W-97	B02	WC-4/0	C04		
W-1255/H7	B05	W-4412	B06	W-98	B02	WC-4/0R	C04		
W-1449	B02	W-4412A	B06	W-H4651	B07	WC-4R	C04		
W-158	B04	W-4414A	B06	W-H4656	B07	WC-6	C04		
W-161	B04	W-4415	B06	W-H5001	B07	WC-6R	C04		
W-1662	B03	W-4415A	B06	W-H5006	B07	WC-CUTTER	H02		
W-168	B04	W-4416	B06	W-H6024	B07	WN-71B	A16		
W-1683	B03	W-4435	B06	W-H6054	B07	WN-72B	A16		
W-1813	B04	W-4436	B06	W-H6054BL	B07	WN-73B	A16		
W-1819	B04	W-4461	B06	W-H7614	B07	WN-74B	A16		
W-1847	B04	W-4466	B06	W-H7616	B07	WN-74W	A16		
W-1864	B04	W-4535	B06	W-H9003	B05	WN-76B	A16		
W-1889	B04	W-4579	B06	W-H9004	B05	WN-76W	A16		
W-1891	B04	W-4589	B06	W-H9005	B05	WN-78W	A16		
W-1893	B04	W-4651	B06	W-H9006	B05	WNC-1/2	D05		
W-1895	B02	W-4652	B06	W-H9007	B05	WNC-1/4	D05		
W-193	B04	W-4860	B06	W-H9406	B07	WNC-3/8	D05		
W-194	B04	W-4921-1	B06	W-H9420	B07	WNC-5/16	D05		
W-194NA	B04	W-53	B02	W-PC194	B04	WS-1	H02		
W-198	B03	W-561	B04	W-PC74	B03	WS-2	H02		
W-199	B03	W-57	B02	W-PR13	B02				
W-1A/27W	B05	W-6014	B06	W-PR18	B02				

QUOTE REQUEST FORM

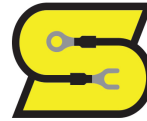

STATE WIRE
AND TERMINAL, INC.
THE COMPANY WITH CONNECTIONS™

BILL TO ADDRESS				SHIP TO ADDRESS			
COMPANY:				COMPANY:			
BUSINESS TYPE:				BUSINESS TYPE:			
ATTENTION:				ATTENTION:			
ADDRESS:				ADDRESS:			
RESIDENTIAL OR COMMERCIAL ADDRESS:				RESIDENTIAL OR COMMERCIAL ADDRESS:			
CITY:		STATE:		CITY:		STATE:	
COUNTRY:		ZIP:		COUNTRY:		ZIP:	
PHONE NUMBER:				PHONE NUMBER:			
FAX NUMBER:				FAX NUMBER:			
SHIP VIA:	UPS	MAIL		COMMON CARRIER			
DATE	SHIP DATE	E-MAIL ADDRESS		WEBSITE			
PART NUMBER		QUANTITY	COMMENTS				
1							
2							
3							
4							
5							
6							
7							
8							
9							
10							
11							
12							
13							
14							
15							
OTHER INFORMATION:							

OFFICE: (248) 634-2020

ORDERS: (800) 922-6527

FAX: (248) 634-2022



16140 DIXIE HWY. • DAVISBURG, MI 48350-1004 • (248) 634-2020 • (800) 922-6527 • FAX (248) 634-2022

APPLICATION FOR CREDIT

P
L
E
A
S
E

P
R
I
N
T

O
R

T
Y
P
E

Y
O
U
R

R
E
S
P
O
N
S
E
S

BUSINESS NAME _____ DBA _____

BILLING ADDRESS _____ SHIP TO _____

CITY-STATE-ZIP _____ CITY-STATE-ZIP _____

TELEPHONE _____ FAX _____

E-MAIL ADDRESS _____

DELIVERY LOCATION: COMMERCIAL RESIDENTIAL

BUSINESS TYPES: SOLE PROPRIETORSHIP PARTNERSHIP CORPORATION LLC

WOULD YOU LIKE YOUR INVOICES AND STATEMENTS: FAXED OR MAILED? (CIRCLE ONE)

BUSINESS STARTED IN _____ YEARS AT THIS LOCATION _____

CHIEF EXEC OFFICER _____ ACCOUNTS PAYABLE MGR _____

BANK NAME _____ **TELEPHONE** _____

MAILING ADDRESS _____ **FAX** _____

ACCOUNT No. _____

BUSINESS _____ **TELEPHONE** _____

MAILING ADDRESS _____ **FAX** _____

ACCOUNT No. _____

BUSINESS _____ **TELEPHONE** _____

MAILING ADDRESS _____ **FAX** _____

ACCOUNT No. _____

BUSINESS _____ **TELEPHONE** _____

MAILING ADDRESS _____ **FAX** _____

ACCOUNT No. _____

T
R
A
D
E

R
E
F
E
R
E
N
C
E
S

ANTICIPATED MONTHLY CREDIT NEEDS: \$ _____

Credit terms are N/30 from invoice date. 1-1/2% per month will be added to all past due invoices (18% per annum).. Statements are mailed the first of each month for reconciliation purposes.

CUSTOMER AUTHORIZATION AND CERTIFICATION:

We certify that the information on this form is correct and agree to make payment within the terms listed above. We understand that the extension of credit is based on our Credit History and authorize the bank and trade references listed on this form to release information to State Wire & Terminal, Inc.

Date Received _____

D & B Rating _____

Approved Denied

Limit _____

Customer # _____

Rev. 020411

Authorization Signature

Name (Printed) Title

Date



16140 DIXIE HWY. • DAVISBURG, MI 48350-1004 • (248) 634-2020 • FAX (248) 634-2022

Dear Customer,

Sales Tax Laws require us to collect a *Sales Tax Exemption Certificate* from all of our customers who do not pay sales tax to us. Please complete the information below and return it to us as soon as possible. Thank you. Your cooperation is greatly appreciated!

The undersigned purchaser, being fully informed concerning its state and local sales tax laws, hereby claims to be legally entitled to exemption from such tax by reason of one or more of the classifications indicated below. This certificate is a continuing one and shall remain in effect until cancelled by written notice. It shall apply to all purchases unless otherwise specified at the time the order is placed.

In the event this claim is disallowed by your state or local taxing authority, the undersigned purchaser agrees to reimburse the seller for the applicable amounts of tax, penalty, and interest involved.

RESALE

MUNICIPALITY

INDUSTRIAL PROCESSING

(PLEASE INDICATE THE PRODUCT(S) MANUFACTURED)

AGRICULTURE

OTHER

COMPANY NAME _____

(PLEASE PRINT THE FULL LEGAL NAME OF YOUR COMPANY.)

ADDRESS _____

SIGNED BY _____

TITLE _____

STATE ID NUMBER _____

CITY ID NUMBER _____

DATE _____

CUSTOMER NUMBER _____

Rev. 02/03/11

**16140 Dixie Hwy
Davisburg, Michigan 48350-1004
Tel 800.922.6527
Fax 248.634.2022
www.statewire.com**